



Model SG13



Model #: \_\_\_\_\_

Serial #: \_\_\_\_\_



Intertek



Intertek



MADE IN THE U.S.A.

## Instruction Manual for the Globe Slicer Model: SG13

For all after sales support, visit [www.globefoodequip.com](http://www.globefoodequip.com)

- Complete the Warranty Registration
- Find an Authorized Servicer
- View Parts Catalogs

For additional Technical Support call Globe at 1-866-260-0522.

### - IMPORTANT SAFETY NOTICE -

This manual contains important safety instructions that must be strictly followed when using this equipment.

**Maintain and use this manual as a reference for training.**

## SG13 Additional Features

1. Four-hour cleaning timer. This timer compliments any HAACP procedures your business has in place, by alerting the users when they are getting near to four hours since making their first slice and stopping the slicer for cleaning when four hours is reached.
2. Timer that turns off the slicer after 30 seconds of non-usage. This is adjustable in 5 second increments from 5 to 60 seconds.
3. Home to Start feature that only allows the slicer to be started when the carriage is in its most forward position, the farthest position from the knife
4. Close to Stop feature, which turns the slicer off when the slice thickness dial is closed from an open position.
5. Carriage Tilt feature that does not allow the slicer to be turned on when the carriage is tilted for cleaning. The only way to tilt the carriage is to have it in the home position and the slice thickness dial completely closed. When the carriage is tilted, the slice thickness dial cannot be rotated.

# Index

|  |       |
|--|-------|
| ADDITIONAL FEATURES .....                        | 2     |
| ATTENTION OWNERS AND OPERATORS.....              | 4     |
| KEY COMPONENTS OF THE SLICER .....               | 5     |
| GLOBE SLICER SAFETY TIPS .....                   | 6     |
| INSTALLATION .....                               | 7-8   |
| OPERATING INSTRUCTIONS.....                      | 9-10  |
| CLEANING & SANITIZING.....                       | 11-14 |
| KNIFE SHARPENING .....                           | 15-16 |
| INSPECTIONS, SIMPLE MAINTENANCE AND REPAIR ..... | 17-18 |
| REMOVABLE CARRIAGE OPTION.....                   | 19-20 |
| KNIFE REMOVAL OPTION.....                        | 21-22 |
| MAINTENANCE MODE.....                            | 23-25 |
| TROUBLESHOOTING GUIDE.....                       | 27    |
| LIMITED SLICER WARRANTY.....                     | 28    |



**GLOBE FOOD EQUIPMENT CO.**  
2153 DRYDEN RD.  
DAYTON, OH 45439  
Toll Free: 800-347-5423  
PHONE: 937-299-5493  
FAX: 937-299-8623  
E-MAIL: [info@globefoodequip.com](mailto:info@globefoodequip.com)  
WEBSITE: [www.globefoodequip.com](http://www.globefoodequip.com)

# Attention Owners and Operators

Globe's equipment is designed to provide years of safe and productive processing of food products as long as the equipment is used in accordance with the instructions in this manual and is properly maintained. Importantly, unless the operator is adequately trained and supervised, there is a possibility of serious injury. Owners of this equipment bear the responsibility to make certain that this equipment is used properly and safely. Strictly follow all of the instructions contained in this manual and the requirements of local, state and federal law.

Owners should not permit anyone to touch this equipment unless they are over 18 years of age, are adequately trained and supervised, and have read and understand this manual. Owners should also ensure that no customers, visitors or other unauthorized personnel come in contact with this equipment. Please remember that Globe cannot anticipate every circumstance or environment in which its equipment will be operated. It is the responsibility of the owner and the operator to remain alert to any hazards posed by the function of this equipment, particularly the sharp knife blade and all moving parts. If you are ever uncertain about a particular task or the proper method of operating this equipment, ask your supervisor.

To prevent illness caused by the spread of food-borne pathogens, it is important to properly clean and sanitize the entire slicer as any surface of the slicer can become contaminated. It is the responsibility of the slicer owner/operator to follow all guidelines, instructions and laws as established by your local and state health departments and the manufacturers of chemical sanitizers.

When cleaning your slicer, pay particular attention to cracks, broken seams and any area that may collect food debris. If your slicer, or any of its parts, is damaged or broken, it may become more difficult to properly clean and sanitize the unit. If your slicer is damaged or needs repair, contact an experienced service individual immediately to ensure the slicer can be properly sanitized. If you have any questions, please contact Globe at 937-299-5493.

This manual offers information to supplement your procedures to improve the sanitization of your machine and contains a Safety Tips section listing a number of precautions to follow to help promote safe use of this equipment. Throughout the manual you will see additional warnings to help alert you to potential hazards.

**Warnings affecting your personal safety are indicated by:**



or



**Warnings related to possible damage to the equipment are indicated by:**



A wall chart with safety instructions is included with this equipment. This wall chart should be posted near the slicer within easy view of the operator. You should make certain that this manual is available for easy reference by any operator. Globe has put several warning labels in the English language on the slicer. French and Spanish labels are also available and can replace the English labels at the owner's discretion. If the warning labels, the wall chart, or this manual are misplaced, damaged or illegible, or if you require additional copies, please contact your nearest representative or Globe directly for these items at no charge.

Please remember that this manual, the wall chart and the warning labels do not replace the need to be alert, to properly train and supervise operators, and to use common sense when using this equipment.

# Key Components of the Slicer

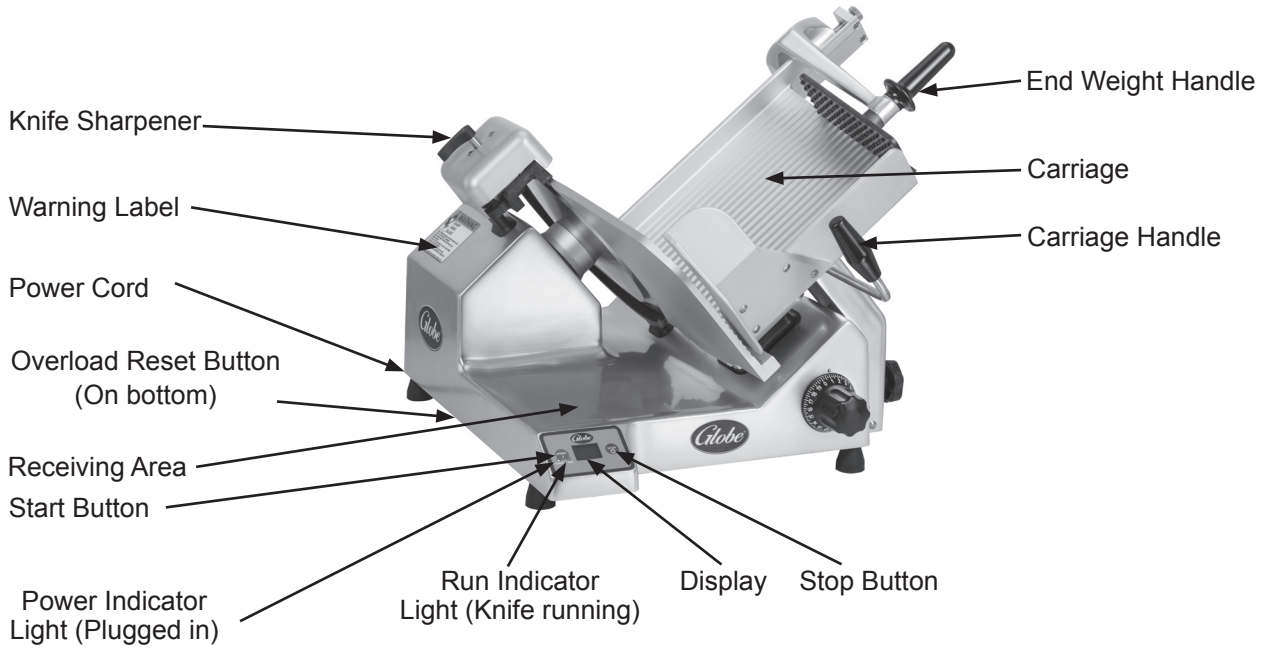

## Model SG13

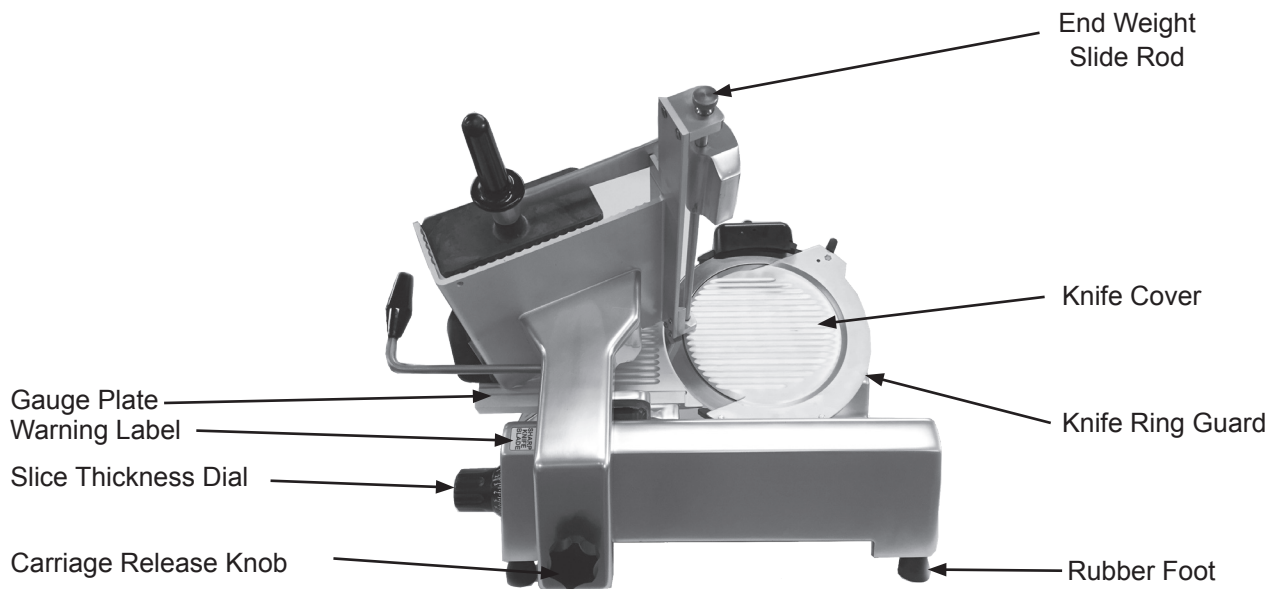

## Globe Slicer Safety Tips

# **WARNING**



## SHARP KNIFE BLADE

### TO AVOID SERIOUS PERSONAL INJURY:

- **NEVER** touch slicer before reading and completely understand everything in this instruction manual. You must be at least 18 years old and have had proper training and authorization from your supervisor.
- **ONLY** install the slicer on a level nonskid surface that is nonflammable and is located in a clean, well-lit work area away from children and visitors.
- **ALWAYS** ground slicer utilizing proper power source.
- **NEVER TOUCH KNIFE.** Keep hands and arms away from all moving parts, hold only the carriage handle.
- **NEVER OPERATE** slicer without knife cover and knife sharpener securely installed.
- **NEVER HOLD THE FOOD PRODUCT WHILE SLICING.** Hold only the carriage handle to slice.
- **DO NOT CATCH SLICES WITH YOUR HAND.** Let slices drop onto the receiving area.
- **ALWAYS** turn knife motor OFF and turn the slice thickness dial clockwise until it stops after each use.
- **BEFORE CLEANING, SERVICING, OR REMOVING ANY PARTS** always turn knife motor OFF, turn the slice thickness dial clockwise until it stops and unplug power cord.
- **ALWAYS** properly clean and sanitize your slicer. To prevent illness or death caused by the spread of food-borne pathogens, it is important to properly clean and sanitize the entire slicer as any surface of the slicer can become contaminated. It is the responsibility of the slicer owner/operator to follow all guidelines, instructions and laws as established by your local and state health departments and the manufacturers of chemical sanitizers.
- **USE ONLY PROPERLY INSTALLED GLOBE SLICER ACCESSORIES.**

# Installation

## UNPACKING

1. Inspect the package carefully before unpacking. Note any damage on the delivery paperwork and take pictures.
2. Unpack the slicer immediately after receipt. If the machine is found to be damaged, save the packaging material and take pictures of damage. Contact the carrier within fifteen (15) days of delivery and immediately contact your source of the equipment. **You have no recourse for damage after fifteen (15) days of receipt.**
2. With the slicer you should receive wall chart, lubricating oil, stiff bristled brush and an instruction manual. Contact Globe or your local supplier if you did not receive all of these items.



## **TO AVOID SERIOUS PERSONAL INJURY PROPERLY INSTALL SLICER IN ADEQUATE WORK AREA**

- **ALWAYS** install equipment in a work area with adequate light and space.
- **ONLY** operate on a solid, level, nonskid surface that is nonflammable.
- **NEVER** operate slicer with a damaged power cord or power plug.
- **NEVER** operate slicer with an extension cord.
- **NEVER** bypass, alter, or modify this equipment in any way from its original condition. Doing so can create hazards and will void warranty.
- **NEVER** operate slicer without the knife cover and knife sharpener securely installed.
- **NEVER** operate slicer without the warning labels attached to slicer (see Key Components of the Slicer section) and the Globe wall chart posted within view of operator.

## INSTALLATION:

1. Read this manual thoroughly before installation and operation. **DO NOT** proceed with installation and operation if you have any questions or if you do not understand everything in the manual. Contact your local representative or Globe first. ***Make sure to clean and sanitize your entire slicer before use. Refer to this manual for cleaning and sanitizing guidelines.***
2. Select a location for the slicer that has a level, solid, nonskid surface that is nonflammable and is in a well-lit work area that is away from children and visitors.



**USE AT LEAST TWO PEOPLE TO LIFT SLICER UP TO OPERATING LOCATION. NEVER ATTEMPT TO LIFT SLICER ALONE.**

3. Remove slicer from the corrugated box.



**NEVER USE SLICER WITHOUT FOUR RUBBER FEET SECURELY INSTALLED ON UNIT.**

4. Make sure rubber feet are firmly tightened.

# Installation



**THIS MACHINE IS PROVIDED WITH A THREE-PRONG GROUNDING PLUG. THE OUTLET TO WHICH THIS PLUG IS CONNECTED MUST BE PROPERLY GROUNDED. IF THE RECEPTACLE IS NOT THE PROPER GROUNDING TYPE, CONTACT AN ELECTRICIAN. DO NOT, UNDER ANY CIRCUMSTANCES, CUT OR REMOVE THE THIRD GROUND PRONG FROM THE POWER CORD OR USE ANY ADAPTER PLUG (Fig. 9-1 and Fig. 9-2).**

5. Inspect slicer to make sure all parts have been provided.
6. Make sure knife cover, knife ring guard and knife sharpener are in place.
7. Make sure warning labels are properly positioned and legible and the instruction manual is available near slicer.
8. Complete warranty registration online at [www.globefoodequip.com/support/warranty-registration-form](http://www.globefoodequip.com/support/warranty-registration-form).
9. Post the provided wall chart in a visible area near slicer. Refer to the wall chart and the Owner's Manual for proper cleaning, sanitizing and inspection of the slicer.
10. Refer to the procedures outlined in Cleaning & Sanitizing section to clean the slicer before use.
11. Contact your local representative, or Globe directly, if you have questions or problems with the installation or operation of the slicer.



Figure 8-1 Correct



Figure 8-2 Incorrect



# Operating Instructions

## **⚠ WARNING**



## **SHARP KNIFE BLADE**

### **TO AVOID SERIOUS PERSONAL INJURY:**

- **NEVER** touch slicer before reading and completely understand everything in this instruction manual. You must be at least 18 years old and have had proper training and authorization from your supervisor.
- **ONLY** install slicer on a level nonskid surface that is nonflammable and is located in a clean, well-lit work area away from children and visitors.
- **ALWAYS** ground slicer utilizing proper power source.
- **NEVER TOUCH KNIFE.** Keep hands and arms away from all moving parts, hold only the carriage handle.
- **NEVER OPERATE** slicer without the knife cover and knife sharpener securely installed.
- **NEVER HOLD FOOD PRODUCT WHILE SLICING.** Hold only the carriage handle to slice.
- **DO NOT CATCH SLICES WITH YOUR HAND.** Let slices drop onto the receiving area.
- **ALWAYS** turn knife motor OFF and turn slice thickness dial clockwise until it stops after each use.
- **BEFORE CLEANING, SERVICING, OR REMOVING ANY PARTS** always turn knife motor OFF, turn slice thickness dial clockwise until it stops and unplug power cord.

### **OPERATION**

**Note:** The slicer is equipped with a four hour cleaning timer. After the four hour cleaning timer expires, all slicer functions will stop and the operator must follow the cleaning steps provided in order to reset the four hour cleaning timer.

#### **FOUR HOUR CLEANING TIMER**

**Note:** This feature is enabled at the factory. The four hour cleaning timer will start when the slicer detects the first slice. To disable this feature, refer to the Maintenance Section of this manual.

**Note:** When 30 minutes are remaining on the four hour cleaning timer, the display will show "ATTENTION: 30 minutes to clean slicer." Slicer will operate as normal when the alert is displayed.

1. To clear alert on display, press and hold the STOP button for three seconds.

**Note:** When 15 minutes are remaining on the four hour cleaning timer, the display will show "ATTENTION: 15 minutes to clean slicer." Slicer will operate as normal when the alert is displayed.

2. To clear alert on display, press and hold the STOP button for three seconds.

**Note:** After the four hour cleaning timer expires, the slicer will no longer operate and display will show "ATTENTION: Unplug and clean slicer to resume."

3. Refer to Cleaning and Sanitizing.
4. Plug in power cord.

**Note:** When the slicer is plugged in the white POWER indicator light will illuminate.

**Note:** If knife cover is not secure the knife motor will not start and the display will show "ATTENTION Knife Cover Removed Install Knife Cover."

**Note:** When carriage is not returned to operating position (to the left), the knife motor will not start and display will show "ATTENTION Carriage Tilted Secure Carriage to Start."

**Note:** If carriage release knob is not secure, slicing performance will be poor and excessive noise could occur.

# Operating Instructions

5. Make sure all knobs are tightened before using slicer.
6. With knife motor turned OFF, pull carriage completely towards you to unload and load food product. Slice only boneless, unfrozen product with the slicer. Use end weight to hold food product in place.
7. Rotate slice thickness dial counterclockwise to the desired setting.
8. Push START button to turn on knife motor.

**Note:** The green RUN indicator light will illuminate and circle on display will spin.

**Note:** If Home-to-Start is enabled and the carriage is not in the home position, the display will show "ATTENTION Return Carriage to Operator to Start."



**DO NOT hold the food product with your hand. Never put your hand on or around carriage when slicer is under power. The carriage handle is the only part of the slicer you should touch while slicing.**

9. Use carriage handle to manually push carriage back and forth. The carriage handle is the only part of slicer you should touch while slicing. Do not catch slices with your hand. Let slices drop onto receiving area.

**Note:** The slicer is equipped with a programmable auto-off timer. After 30 seconds (factory default) of no carriage movement, the knife motor will shut off.



**If a product needs to be adjusted during slicing, ALWAYS pull the carriage all the way towards you. Turn off slicer, and close gauge plate prior to adjusting the product and the end weight.**

10. After the last slice stroke, pull carriage all the way towards you. Push the STOP button to turn knife motor OFF.

**Note:** The green RUN indicator light will go out and circle on display will stop spinning.

**Note:** The slicer is also equipped with a Close to Stop feature. When the slice thickness dial is closed, the knife motor will stop.

11. Turn slice thickness dial clockwise until it stops to close gauge plate. Pull carriage home to unload and load food product.
12. Unplug slicer after each days use or before cleaning and servicing.

# Cleaning & Sanitizing

## WARNING



## SHARP KNIFE BLADE

**TO AVOID SERIOUS PERSONAL INJURY TO THE SLICER OPERATOR AND CUSTOMERS:**

- **NEVER** touch slicer before reading and completely understand everything in this instruction manual. You must be at least 18 years old and have had proper training and authorization from your supervisor.
- **BEFORE CLEANING, SERVICING OR REMOVING ANY PARTS** always turn knife motor OFF, turn slice thickness dial clockwise until it stops and unplug power cord.
- **NEVER** attempt to clean slicer with knife running.
- **NEVER** attempt to remove knife or knife ring guard from slicer. They must remain on slicer for proper operation, sharpening and cleaning.

## WARNING

To prevent illness or death caused by the spread of food-borne pathogens, it is important to properly clean and sanitize the entire slicer as any surface of the slicer can become contaminated. It is the responsibility of the slicer owner/operator to follow all guidelines, instructions and laws as established by your local and state health departments and the manufacturers of chemical sanitizers.



**Once your slicer makes contact with food product, the entire slicer, including removable parts, must be thoroughly cleaned and sanitized. This process is to be repeated at least every 4 hours using these procedures and information; and must comply with additional laws from your state and local health departments.**



As with all food contact surfaces, it is extremely important to properly sanitize the entire slicer and to **closely follow the instructions on your quaternary sanitizer container to make sure proper sanitation is achieved to kill potentially harmful bacteria.**

**Note:** It may be desirable to wear cut proof safety gloves during the cleaning operation.

**IMPORTANT:** If a chemical sanitizer other than chlorine, iodine or quaternary ammonium is used, it must be applied in accordance with the EPA-registered label use instructions. Excessive amounts of sanitizer and use of products not formulated for stainless steel or aluminum may VOID your warranty.

Sanitizer concentration must comply with section 4-501.114, Manual and Mechanical Warewashing Equipment, Chemical Sanitization - Temperature, pH, Concentration, and Hardness of the FDA Food Code.

**For more information on proper kitchen and equipment sanitation, visit [www.servsafe.com](http://www.servsafe.com) provided by the National Restaurant Association (NRA).**

## CAUTION

- **DO NOT** hose down, pressure wash or pour water on slicer.
- **NEVER** use a scrubber pad, steel wool or abrasive material to clean slicer.
- **ALWAYS** turn slicer OFF and unplug power cord BEFORE cleaning.
- **It is extremely important to follow the instructions on the sanitizer container to make sure proper sanitation is achieved. Allow the parts to air dry before placing them back on slicer!**

**DO NOT** use bleach, products containing sodium hypochlorite or other caustic/strong detergents on slicer base or removable parts. These products will discolor and destroy the parts.

Slicer components are easily disassembled without the use of special tools. It may be desirable to wear cut proof safety gloves during the cleaning operation.

# Cleaning & Sanitizing

## DISASSEMBLY & CLEANING

**Note:** The slicer is equipped with a four hour cleaning timer. After the four hour cleaning timer expires, all slicer functions will stop and the operator must follow the cleaning steps provided in order to reset the four hour cleaning timer.

1. Push STOP button to turn off knife motor.
2. Turn slice thickness dial clockwise past zero (0) until it stops so gauge plate covers knife edge.
3. Unplug power cord.

**Note:** When slicer is unplugged the white POWER indicator light will go out.

4. Pull the carriage towards you (home position).
5. Loosen the carriage release knob that fastens the carriage to the slicer (Fig. 12-1).

**Note:** The carriage release knob is not designed to come completely off.

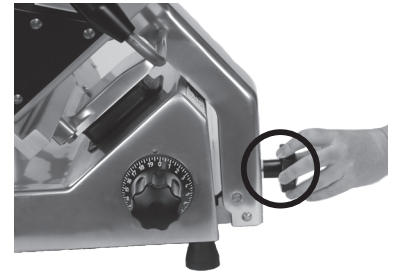

Figure 12-1

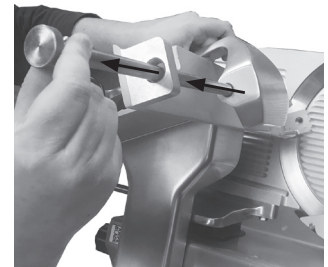

Figure 12-4

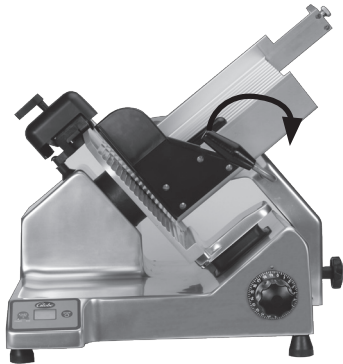

Figure 12-2

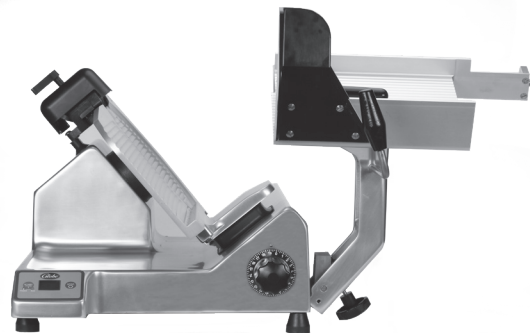

Figure 12-3 Cleaning Position

**Note:** If slicer is equipped with the removable carriage option, refer to Removable Carriage Option section for disassembly.

6. Use the carriage handle to tilt carriage and carriage arm to the right to the cleaning position (Fig. 12-2 and Fig. 12-3).
7. Remove carriage's end weight. Hold end weight and unscrew end weight slide rod (Fig. 12-4). Pull end weight slide rod out of pivot of end weight.
8. With a clean cloth soaked in mild detergent, wipe down the carriage. Use a clean, wet cloth to rinse the carriage.



**BE ALERT. The next step will expose knife.**

9. Remove knife cover. Push down on knife cover release lever. Hold the knife cover release lever and pull knife cover forward to remove knife cover from top pin (Fig. 12-5).
10. Hold the knife cover release lever. Carefully tilt knife cover and pull knife cover up and to the right to remove the knife cover from bottom pins.
11. Remove knife sharpener. Pull knife sharpener up and away to remove from slicer (Fig. 12-6).
12. Use the stiff bristled brush provided and hot soapy water to clean the sharpening stones.

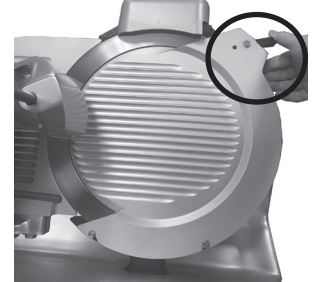

Figure 12-5



Figure 12-6

# Cleaning & Sanitizing

**Note:** If slicer is equipped with the removable knife option, refer to Removable Knife Option section for disassembly.

**BE ALERT.** Slicer knife edge is exposed. Always be aware of the placement of your hands/fingers in relationship to knife.

Place all removable parts in a three compartment sink with warm water and a mild detergent solution; soak, clean, and thoroughly scrub all surfaces using a solution of mild detergent and warm water. Removable parts include: end weight, slide rod, knife cover and knife sharpener.

Rinse removable parts with fresh, clean water. Following the instructions on your quaternary sanitizer label, soak the end weight, slide rod, knife cover and knife sharpener in a proper solution of quaternary sanitizer for a minimum of two minutes. Allow these parts to air dry.

**An important step to kill bacteria is to allow the parts to air dry before reassembly!**

**BE ALERT.** The slicer knife is fully exposed. Always be aware of the placement of your hands/fingers in relationship to the knife.

12. Next, clean knife ring guard. Soak a clean cloth in a mild detergent and warm water solution. Ring out excess water from cloth. **Carefully** insert the cloth between knife and knife ring guard (Fig. 13-1). While holding the cloth between knife and knife ring guard, work it along the entire inside surface of ring guard. Repeat this procedure as necessary.



Figure 13-1

13. The knife must also be cleaned and sanitized. **Carefully** wash and rinse the top and bottom of knife by wiping from the **center of knife outward** (Fig. 13-2). Spray both sides of knife, gauge plate and the entire slicer base with a non-bleach, non-chlorine sanitizer following the instructions on your quaternary sanitizer container to make sure proper sanitation is achieved. Allow slicer parts to air dry.

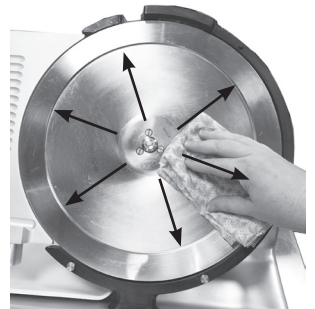

Figure 13-2

**An important step to kill bacteria is to allow the parts to air dry before reassembly!**

**CAUTION** After cleaning and sanitizing the knife, the rest of the entire slicer must be fully cleaned, sanitized and left to air dry before reattaching slicer parts and using the slicer.

14. Soak a clean cloth in a mild detergent and warm water solution. Wring out excess water from cloth. With the gauge plate completely closed, wipe gauge plate off by starting at knife and pulling towards you. Never wipe gauge plate towards knife.

15. With a clean cloth soaked in mild detergent, wipe down all remaining surfaces of slicer to remove food, debris and grease/oil. Use a nylon brush to scrub difficult areas. Use a clean, wet cloth to rinse the entire slicer. Finish by spraying sanitizer on all surfaces and then let air dry.

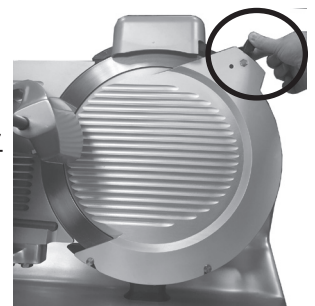

Figure 13-3

## **REINSTALL REMOVABLE PARTS**

After cleaning, sanitizing, and allowing the parts to air dry, they must be reinstalled.

**BE ALERT.** Slicer knife is exposed. Always be aware of the placement of your hands/fingers in relationship to knife.

1. Reinstall the knife cover. Align the knife cover with the pins located at the bottom and one at the top of the knife guard. The locator pin at the top of the knife ring guard must be set through the knife cover and pressed into place. Once the knife cover hole is seated over the pin, lift the cover release lever back to the up position to secure knife cover (Fig. 13-3).



Figure 13-4

# Cleaning & Sanitizing

2. Reinstall knife sharpener. Put knife sharpener at the top of slicer with knife sharpener handle pointing down (Fig. 14-4).

**Note:** When knife sharpener is in stored position, label should display "STORED POSITION LIFT AND ROTATE TO SHARPEN."



**NEVER** operate slicer without knife sharpener installed. Make sure it is in place and fully seated on top of slicer before operating.

3. Put the cleaned and sanitized carriage back into operation (Fig. 14-1).

**Note:** If slicer is equipped with the removable carriage option, refer to Removable Carriage Option section for assembly.

4. Tighten carriage release knob to secure carriage to slicer (Fig. 14-2).



Figure 14-1

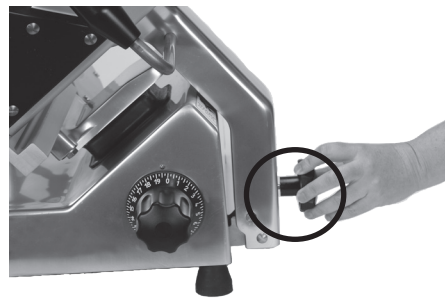

Figure 14-2

5. Reinstall end weight. Align end weight with chute and insert end weight slide rod through chute and end weight (Fig 14-3). Allow end weight to rest on chute and securely screw in end weight slide rod to slicer chute. Refer to Inspection, Simple Maintenance, and Repair section for instructions on how to lubricate the end weight slide rod.

6. Plug in power cord.

**Note:** When slicer is plugged in, the white POWER indicator light will illuminate.

**Note:** If knife cover is not secure the knife motor will not start and the display will show "ATTENTION Knife Cover Removed Install Knife Cover."

**Note:** When carriage is not returned to operating position (to the left), the knife motor will not start and display will show "ATTENTION Carriage Tilted Secure Carriage to Start."

**Note:** If carriage release knob is not secure, slicing performance will be poor and excessive noise could occur.

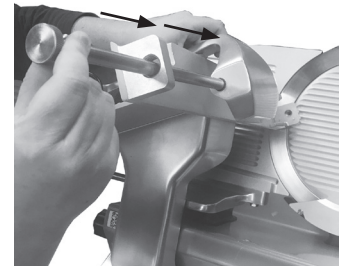

Figure 14-3

## FOUR HOUR CLEANING TIMER

**Note:** This feature is enabled at the factory. The four hour cleaning timer will start when the slicer detects the first slice. To disable this feature, refer to the Maintenance Section of this manual.

**Note:** When 30 minutes are remaining on the four hour cleaning timer, the display will show "ATTENTION: 30 minutes to clean slicer." Slicer will operate as normal when the alert is displayed.

1. To clear alert on display, press and hold the STOP button for three seconds.

**Note:** When 15 minutes are remaining on the four hour cleaning timer, the display will show "ATTENTION: 15 minutes to clean slicer." Slicer will operate as normal when the alert is displayed.

2. To clear alert on display, press and hold the STOP button for three seconds.

**Note:** After the four hour cleaning timer expires, the slicer will no longer operate and display will show "ATTENTION: Unplug and clean slicer to resume."

3. Refer to Cleaning and Sanitizing.

# Knife Sharpening

**WARNING**



## SHARP KNIFE BLADE

### TO AVOID SERIOUS PERSONAL INJURY:

- **NEVER** touch slicer before reading and completely understand everything in this instruction manual. You must be at least 18 years old and have had proper training and authorization from your supervisor.
- **NEVER** touch rotating knife.
- **ALWAYS** keep hands clear of all moving parts.
- **ALWAYS** turn slicer off, turn slice thickness dial clockwise until it stops and pull carriage completely towards you before sharpening.
- **NEVER** sharpen knife unless knife cover is installed.

### WHEN AND HOW OFTEN TO SHARPEN KNIFE

1. Symptoms of a dull knife are excess waste (or “tail”) on the unsliced portion remaining in carriage.
2. The knife needs to be sharpened periodically to provide consistent slices and maximum food product yield. Sharpening knife lightly every few days is more effective than heavy sharpening at less frequent intervals.

### PREPARING TO SHARPEN

1. Unplug the slicer and turn slice thickness dial clockwise until it stops so gauge plate covers knife’s edge.
2. Clean and dry both sides of knife before sharpening. Refer to Cleaning & Sanitizing section.



**BE ALERT. The next step will expose knife.**

3. Slide knife sharpener up its mounting post and rotate it 180 degrees (Fig. 15-1).
4. Lower knife sharpener with handle pointing up (Fig. 15-2).
5. Push down knife sharpener until knife sharpener clicks into position.



Figure 15-1  
Stored Position



Figure 15-2  
Sharpening Position

# Knife Sharpening

## SHARPENING THE KNIFE

**Note:** Sharpening and honing stones will perform correctly **ONLY** when free from dirt, grease and built-up food residue. Use the wire brush included with your slicer to periodically clean the stones **BEFORE** sharpening the knife blade.

1. Plug in power cord.

**Note:** The white **POWER** indicator light will illuminate.

2. Push the **START** button to turn on knife motor.

**Note:** The green **RUN** indicator light will illuminate.

3. Pull knife sharpener handle toward the front so the stone and honing plate make contact with knife (Fig. 16-1). Maintain pressure on the knife sharpener handle for 3-5 seconds.



Figure 16-1  
Sharpening Position



**TURN KNIFE MOTOR OFF** before inspecting.

## AFTER SHARPENING

1. Push the **STOP** button to turn knife motor off.

**Note:** The green **RUN** indicator light will go out.

2. Unplug power cord.

**Note:** The white **POWER** indicator light will go out.

3. Lift knife sharpener up and away to remove for cleaning.
4. **Clean and sanitize** the entire slicer. Refer to Cleaning & Sanitizing section.

5. Plug in power cord.

**Note:** When slicer is plugged in, the white **POWER** indicator light will illuminate.



**NEVER** operate slicer without knife sharpener installed. Make sure it is in place and secure to top of slicer before operating.

6. Install knife sharpener on slicer in its stored position (Fig. 16-2).

**Note:** When knife sharpener is in stored position, label should display “**STORED POSTION LIFT AND ROTATE TO SHARPEN.**”



Figure 16-2  
Stored Position



# Inspections, Simple Maintenance, and Repair

**WARNING**



## SHARP KNIFE BLADE TO AVOID SERIOUS PERSONAL INJURY:

- **NEVER** touch slicer before reading and completely understand everything in this instruction manual. You must be at least 18 years old and have had proper training and authorization from your supervisor.
- **BEFORE CLEANING, SERVICING, OR REMOVING ANY PARTS** always turn OFF and unplug slicer, and turn slice thickness dial clockwise past zero (0) until it stops.
- **NEVER TOUCH KNIFE.** Keep hands and arms away from all moving parts.
- **DO NOT** tamper with, bypass or remove any safety devices, guards, START/STOP button or touch pad controls.
- **AFTER EACH USE, ALWAYS** turn slicer OFF and turn the slice thickness dial clockwise past zero (0) until it stops.
- **USE ONLY PROPERLY INSTALLED GLOBE PARTS AND ACCESSORIES.**

### INSPECTING THE SLICER

INSPECT THE SLICER FOR DAMAGED OR BROKEN PARTS INCLUDING GASKETS & SEALS. A thorough visual inspection should be made of the entire slicer and its parts. Globe urges the owner/operator to inspect all components often and for an authorized service agent to inspect the entire slicer at least every 6 months, including all parts that are detachable for cleaning and sanitizing. This inspection should include looking for damaged parts, broken seals or gaskets, and areas that may be more difficult to clean and sanitize.

**WARNING**

IF A SEAL OR GASKET IS FOUND TO NOT PROPERLY SEAL, IS DAMAGED OR IS MISSING, THE SLICER MUST BE REMOVED FROM SERVICE UNTIL IT IS REPAIRED BY AN AUTHORIZED SERVICER.

### SLICER INSPECTION

Slicer Seals and Gaskets Identified

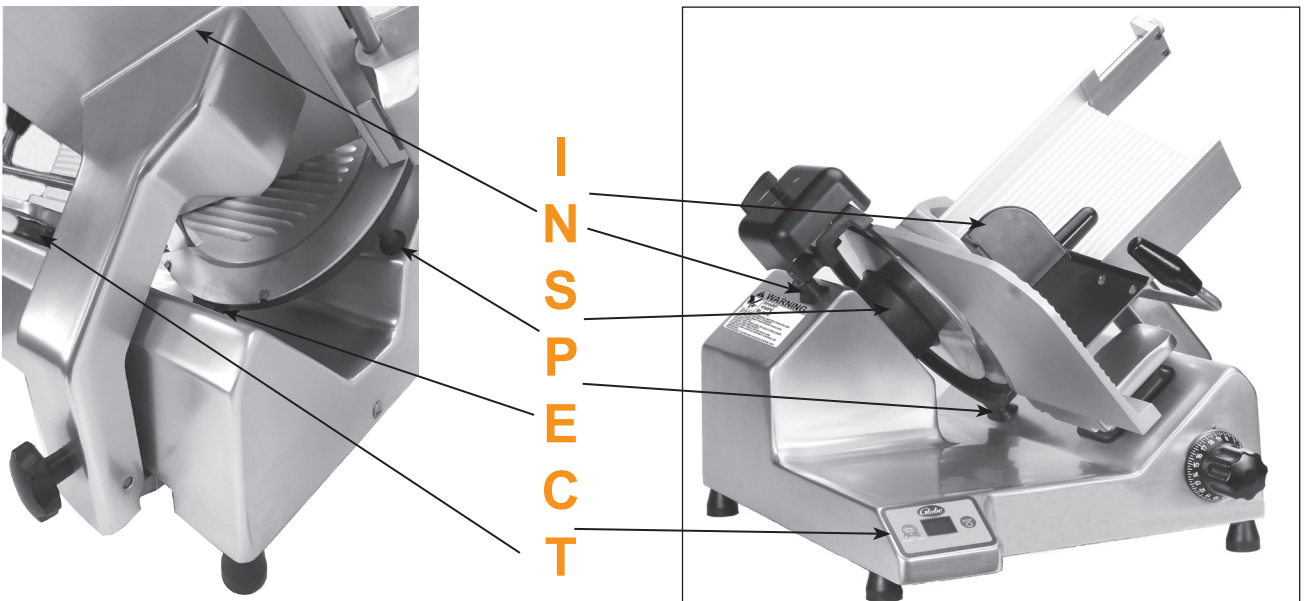

# Inspections, Simple Maintenance, and Repair

## LUBRICATION

Various slicer parts need to be lubricated periodically using Globe oil. Globe oil is a light, tasteless, odorless mineral oil that will not contaminate or impart odors or taste to sliced food products.



**DO NOT USE VEGETABLE OIL TO LUBRICATE SLICER. VEGETABLE OIL WILL DAMAGE THE SLICER!**

## Sharpener and Shafts

In addition to cleaning the sharpener stones, it is suggested that the sharpener shafts be lubricated with Globe oil on a regular basis.

1. Pull knife sharpener up by its handle to remove it from slicer (Fig. 18-1).
2. Apply several drops of Globe oil to the exposed shaft of both stones (Fig. 18-2).
3. Push the sharpener handle several times to distribute the oil onto shafts.
4. Replace sharpener to its stored position on the slicer.
5. Wipe off any excess oil that drips onto slicer.

**Note:** The knife sharpener and stones can be cleaned with warm water and a brush. Allow it to air dry. If the knife sharpener or stones are cleaned, it is very important that all sharpener shafts are lubricated with Globe oil afterwards!

## End Weight Slide Rod

The end weight slide rod should be lubricated with a few drops of Globe oil every week or when excessive drag is felt.

1. Apply a few drops of Globe oil to end weight slide rod (Fig. 18-3).
2. Slide end weight up and down to distribute oil.
3. Wipe off any excess oil that drips onto the slicer.



Figure 18-1

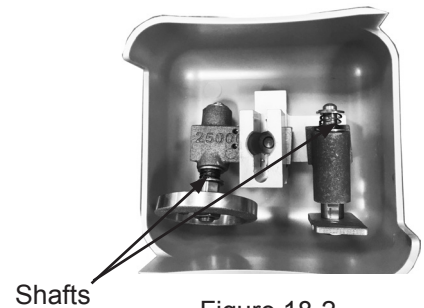

Figure 18-2

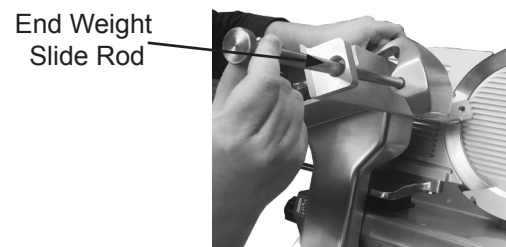

Figure 18-3

# Removable Carriage Option

## REMOVABLE CARRIAGE OPTION

A factory available, removable carriage option allows the carriage to be removed.

### Removal of Removable Carriage

1. Push STOP button to turn off knife motor.
2. Turn slice thickness dial clockwise past zero (0) until it stops so gauge plate covers knife edge.
3. Unplug power cord.

**Note:** When slicer is unplugged the white POWER indicator light will go out.

4. Pull carriage toward you (home position).

**Note:** The carriage will only tilt back in the “home” position.

5. Loosen the carriage release knob that fastens the carriage to the slicer (Fig. 19-1).

**Note:** The carriage release knob is not designed to come completely off.

6. Use the carriage handle to tilt carriage and carriage arm to the right to the cleaning position (Fig. 19-2).

7. Remove carriage's end weight. Hold end weight and unscrew end weight slide rod (Fig. 19-3). Pull end weight slide rod out of pivot of end weight.

8. Loosen the removable carriage knob to remove the removable carriage from the carriage arm (Fig. 19-4).

**Note:** The removable carriage knob is not designed to come completely off.

9. Use two hands to lift removable carriage from carriage arm (Fig. 19-5).

10. Refer to Cleaning & Sanitizing for instructions on how to clean the removable carriage.

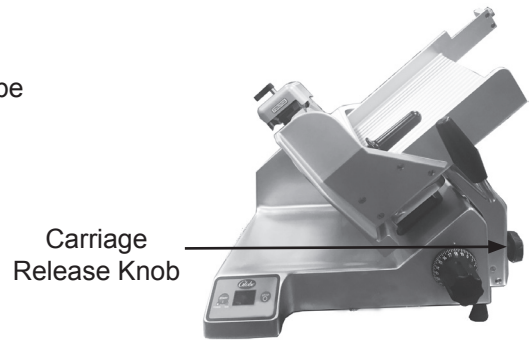

Figure 19-1



Figure 19-2

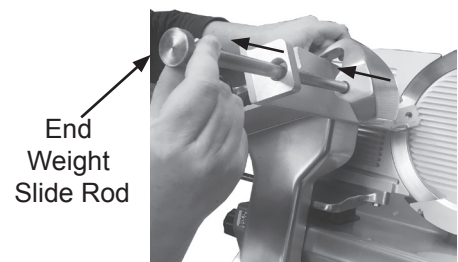

Figure 19-3

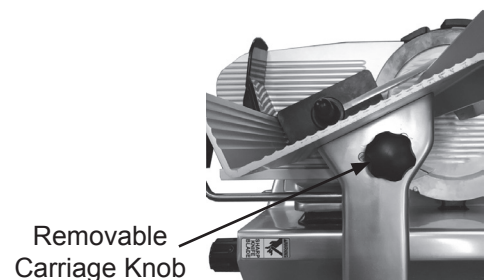

Figure 19-4

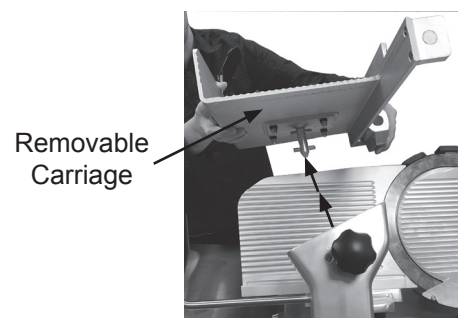

Figure 19-5

# Removable Carriage Option

## Installation of Removable Carriage

After cleaning, sanitizing, and allowing the removable carriage to air dry, it must be reinstalled.

1. Use two hands to install removable carriage (Fig. 20-1).
2. Align peg on bottom of the removable carriage with slot in the carriage arm (Fig. 20-2).
3. Reinstall end weight. Align end weight with chute and insert end weight slide rod through carriage and end weight (Fig 20-3). Allow end weight to rest on carriage and securely screw in end weight slide rod to slicer chute. Refer to Inspection, Simple Maintenance, and Repair section for instructions on how to lubricate the end weight slide rod.
4. Tighten the removable carriage knob to secure the removable carriage to the carriage arm (Fig. 20-4).
5. Put the cleaned and sanitized carriage back into operation (Fig. 20-5).
6. Tighten carriage release knob to secure carriage to slicer (Fig. 20-6).
7. Plug in power cord.



Figure 20-1



Figure 20-2

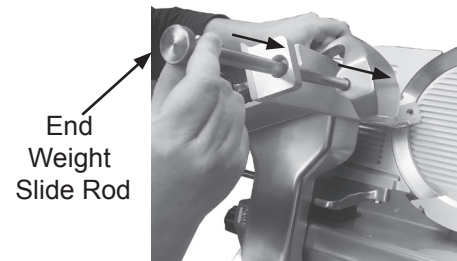

Figure 20-3

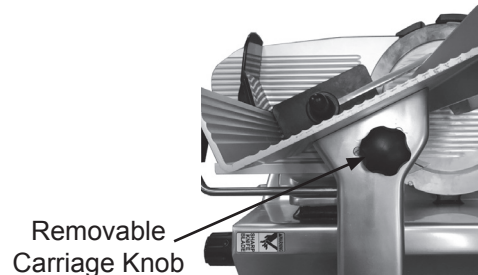

Figure 20-4

**Note:** When slicer is plugged in, the white **POWER** indicator light will illuminate.



Figure 20-5

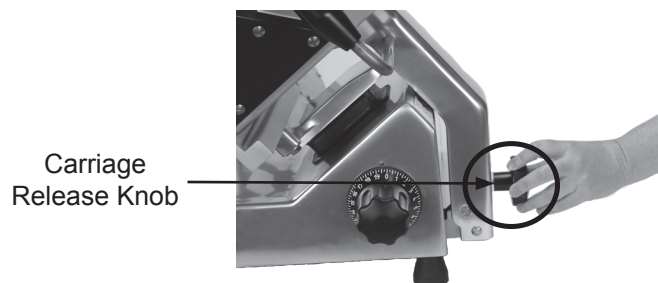

Figure 20-6

# Knife Removal Option

## KNIFE REMOVAL OPTION

A factory available, knife removal option allows the knife to be removed.

### Knife Removal



Use two hands when handling knife removal tool.  
If dropped, damage to knife and knife remove tool can occur.  
Replace knife removal tool.

1. Turn knife motor off, turn slice thickness dial clockwise past zero (0) until it stops so the gauge plate covers the knife edge, and unplug the power cord. Wipe off all visible food/food debris and juices from the entire slicer.
2. Carefully wash and rinse the top of knife by wiping from the center of knife outward (Fig. 21-1).
3. On the shaft under the knife, align (-) with (▲) (Fig. 21-2).
4. Before installing knife removal tool, both handles must be rotated outward (Fig. 21-3).
5. Align knife removal tool with locations on ring guard (Fig. 21-4).
6. Use hand to firmly turn top handle inward (Fig. 21-5).
7. Use hand to firmly turn bottom handle inward (Fig. 21-6).
8. Use both handles to lift knife removal tool & knife away from slicer (Fig. 21-7).
9. With the knife securely attached to the removal tool, clean and sanitize knife and knife removal tool in sink or dishwasher.



Figure 21-1



Figure 21-2



Figure 21-3



Figure 21-4



Figure 21-5



Figure 21-6



Figure 21-7

# Knife Removal Option

## Knife Installation

### **CAUTION**

Use two hands when handling knife removal tool.  
If dropped, damage to knife and knife remove tool can occur. Replace knife removal tool.

1. On the shaft under the knife, align (+) with (▲) (Fig. 22-1).
2. Align knife removal tool with locations on ring guard (Fig. 22-2).
3. Use hand to firmly turn bottom handle outward (Fig. 22-3).
4. Use hand to firmly turn top handle outward (Fig. 22-4).
5. Use both hands to lift tool away from knife removal tool (Fig. 22-5).



Figure 22-1



Figure 22-2



Figure 22-3



Figure 22-4

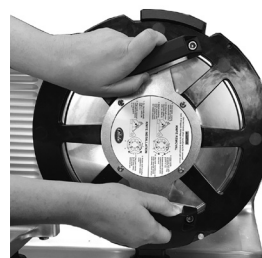

Figure 22-5

# Maintenance Mode

Maintenance Mode is made up of four sub menu displays, Setup Parameters, Diagnostics, System Counters and Information. Refer to the table below for the options and actions of each available menu display.

## Entering Maintenance Mode

Two options are available for entering the maintenance mode.

Option One:

1. Unplug the slicer.
2. While holding down the STOP button, plug in the slicer. During start up the display will show “Entering Maintenance Mode.”

**Note: Once Maintenance Mode has been entered, use the STOP button to navigate through selections and the START button to select the option.**

Option Two:

1. Remove the knife cover.  
**Note:** When knife cover is removed, the knife motor will not start and display will show “ATTENTION Knife Cover Removed Install Knife Cover.”
2. Hold down the STOP button. An “\*” in the top left corner of the display screen will appear. Release the STOP button when the “\*” disappears from the display.
3. When the Globe logo appears, press and hold the STOP button. The display will show “Entering Maintenance Mode.”
4. Repeat steps 1-3 if display does not show the “Entering Maintenance Mode” screen.

**Note: Once Maintenance Mode has been entered, use the STOP button to navigate through selections and the START button to select the option.**

| MENUS               | OPTIONS  | ACTION  |
|---------------------|--|---|
| <b>User Options</b> |  |   |
| Home-to-Start       | Enable or Disable<br>Factory Default is set to Enable  | When enabled and the carriage is not in the home position, the knife motor will not start. ATTENTION Return Carriage to Operator to start will display.           |
| Close-to-Stop       | Enable or Disable<br>Factory Default is set to Enable  | When enabled and the slice thickness dial is closed, the knife motor will stop.   |
| Motion Timer        | Enable or Disable<br>OFF, 5-60 seconds in 5 second increments<br>Factory Default is set to 30 seconds    | When enabled and the carriage is not in use for 30 seconds, the knife motor will stop. Settings can be adjusted from 5 seconds up to 60 second increments.        |
| Backlight Timer     | Enable or Disable<br>OFF, 10-60 seconds in 10 seconds increments<br>Factory Default is set at 30 seconds | When enabled and the slicer is not in use for 30 seconds, the backlight display will go off. Settings can be adjusted from 10 seconds up to 60 second increments. |
| Cleaning Timer      | Enable or Disable<br>Factory Default is set to Enable  | When enabled the 4 hour cleaning timer will begin with the first detected slice.  |

# Maintenance Mode

| MENUS                                 | OPTIONS   | ACTION  |
|---------------------------------------|---|---|
| <b>Diagnostics</b>                    |   |   |
| Status                                | Used to determine if the machine sensors are functioning properly. Select a button or sensor to test machine. | Example: When the START button is selected and the safety sensor is working properly, "Start" on the display will illuminate. |
| <b>System Counters</b>                |   |   |
| <b>Counter Mode</b>                   |   |   |
| <b>Examine</b>                        |   |   |
| Powered Up Total                      | Displays the total amount of time the slicer has been plugged in.   | No action required.   |
| Knife On Total                        | Displays the total amount of time in hours that the knife motor has ran.                                      | No action required.   |
| Auto Mode Total<br>(Model SG13A only) | Displays the total amount of time in hours that the slicer has been used in auto mode.                        | No action required.   |
| Power Cycles                          | Displays the total amount of times the slicer has been connected to power.                                    | No action required.   |
| Total Slices                          | Counts the number of strokes made with the knife running.   | No action required.   |
| <b>Additional Counters</b>            |   |   |
| Manual Slices                         | Displays the total number of slices in manual mode.   | No action required.   |
| Speed 1                               |   |   |
| Stroke                                |   |   |
| 1                                     | N/A   | N/A   |
| 2                                     | N/A   | N/A   |
| 3                                     | N/A   | N/A   |
| Speed 2                               |   |   |
| Stroke                                |   |   |
| 1                                     | N/A   | N/A   |
| 2                                     | N/A   | N/A   |
| 3                                     | N/A   | N/A   |
| Speed 3                               |   |   |
| Stroke                                |   |   |
| 1                                     | N/A   | N/A   |
| 2                                     | N/A   | N/A   |
| 3                                     | N/A   | N/A   |
| Speed 4                               |   |   |
| Stroke                                |   |   |
| 1                                     | N/A   | N/A   |
| 2                                     | N/A   | N/A   |
| 3                                     | N/A   | N/A   |



# Maintenance Mode

| MENUS                                 | OPTIONS   | ACTION   |
|---------------------------------------|---|--|
| <b>Reset</b>                          |   |  |
| Knife Motor                           | Displays the Reset Knife Timer.   | Press STOP to verify reset operation.  |
| Auto Mode Motor<br>(Model SG13A only) | Displays the Auto Timer Motor.  | Press STOP to verify reset operation.  |
| <b>Language Setup</b>                 | “ATTENTION” screens will alternate between Language 1 and Language 2 displaying each for 5 seconds. | No action required.  |
| Language 1                            | Displays primary language.  | No action required.  |
| English                               | Displays language options English, French and Spanish.  | Select START button to select language.<br>Press STOP button once language selection has been made.<br>Select START button to Save and Exit. |
| French                                | Displays language options English, French and Spanish.  | Select START button to select language.<br>Press STOP button once language selection has been made.<br>Select START button to Save and Exit. |
| Spanish                               | Displays language options English, French and Spanish.  | Select START button to select language.<br>Press STOP button once language selection has been made.<br>Select START button to Save and Exit. |
| Language 2                            | Displays secondary language.  | No action required.  |
| English                               | Displays language options English, French and Spanish.  | Select START button to select language.<br>Press STOP button once language selection has been made.<br>Select START button to Save and Exit. |
| French                                | Displays language options English, French and Spanish.  | Select START button to select language.<br>Press STOP button once language selection has been made.<br>Select START button to Save and Exit. |
| Spanish                               | Displays language options English, French and Spanish.  | Select START button to select language.<br>Press STOP button once language selection has been made.<br>Select START button to Save and Exit. |
| <b>Information</b>                    | Displays the Model Number, Rated Input Voltage and Software version.                                | No action required.  |

Intentionally Left Blank

# Troubleshooting Guide

| PROBLEM                     | CAUSE   | SOLUTION  |
|-----------------------------|---|---|
| Knife motor will not start  | Slicer not plugged in   | Plug in slicer  |
|                             | Knife cover removed or not properly installed   | Install knife cover   |
|                             | Overload reset button tripped   | Press the reset button located underneath the slicer  |
|                             | Carriage not in home position   | Pull carriage to operator to start  |
|                             | Carriage in the tilted position   | Secure carriage to resume   |
|                             | Four hour cleaning timer is enabled   | Refer to Cleaning section   |
| Knife motor stopped running | Motion timeout is enabled and no carriage movement has been detected in the time specified in the maintenance mode menu | Adjust the amount of seconds until timeout in the maintenance mode menu                                       |
|                             | Carriage release knob closed  | Adjust carriage release knob and select START   |
| Ragged cuts-poor yield      | Dull knife  | Sharpen knife-make sure knife and stones are clean  |
|                             | Chipped knife   | Sharpen or have new knife installed   |
|                             | Knife-gauge plate gap too wide  | Call for service to adjust gauge plate  |
|                             | Knife too small   | Have new knife installed  |
| Part scraping knife         | Knife cover   | Lock knife cover release lever  |
|                             | Carriage  | Tighten or adjust carriage knob   |
|                             | Gauge plate   | Call for service to adjust gauge plate  |
| Hard to sharpen             | Stones dirty, wet or clogged with grease  | Clean stones with warm water and a brush. Allow stones to air dry. Lubricate shafts with Globe oil afterwards |
|                             | Knife dirty   | Clean top and bottom of knife   |
|                             | Worn stones   | Have stones replaced  |
|                             | Stones not properly aligned   | Have sharpener adjusted   |

If problems persist and the assigned solution does not remedy the issue, please call our Service Department at 866-260-0522.

# Limited Slicer Warranty

Globe Food Equipment Company (“GFE”) warrants to the original purchaser of new equipment that said equipment, when installed in accordance with our instructions within North America and subjected to normal use, is free from defects in material or workmanship for a period of 30 months from date of factory shipment, or 24 months from date of installation, whichever comes first. There is a lifetime guarantee on the stones in the sharpening system (parts only).

THIS WARRANTY IS IN LIEU OF ALL OTHER WARRANTIES, WHETHER EXPRESSED OR IMPLIED. GFE EXPRESSLY DISCLAIMS ANY IMPLIED WARRANTY OF MERCHANTABILITY OR EXPRESSED OR IMPLIED WARRANTY OF FITNESS FOR A PARTICULAR PURPOSE.

GFE’S OBLIGATION AND LIABILITY UNDER THIS WARRANTY IS EXPRESSLY LIMITED TO REPAIRING OR REPLACING EQUIPMENT WHICH PROVES TO BE DEFECTIVE IN MATERIAL OR WORKMANSHIP WITHIN THE APPLICABLE WARRANTY PERIOD. All repairs pursuant to this Warranty will be performed by an Authorized Designated GFE Service Location during normal working hours. IN NO EVENT SHALL GFE BE LIABLE FOR INCIDENTAL OR CONSEQUENTIAL DAMAGES TO BUYER OR ANY THIRD PARTY, INCLUDING, WITHOUT LIMITATION, LOSS OF PROPERTY, PERSONAL INJURY, LOSS OF BUSINESS OR PROFITS OR OTHER ECONOMIC LOSSES, OR STATUTORY OR EXEMPLARY DAMAGES, WHETHER IN NEGLIGENCE, WARRANTY, STRICT LIABILITY OR OTHERWISE.

This warranty is given only to the first purchaser from a retail dealer. This warranty is not transferable or assignable to any subsequent owner.

This warranty does not cover product failures caused by: failure to maintain, neglect, abuse, damage due to excess water, fire, normal wear, improper set up and use. Periodic maintenance including lubrication and sharpening are not covered.

Items not covered under warranty, but are not limited to:

1. Acts of God, fire, water damage, burglary, accident, theft, vandalism.
2. Freight damage.
3. Improper installation or alteration of equipment.
4. Use of generic or after market parts.
5. Repairs made by anyone other than a GFE designated servicer, or not pre-authorized by GFE.
6. Lubrication.
7. Expendable wear parts, knife, rubber boots, blown fuses, lamps.
8. Cleaning of equipment.
9. Misuse or abuse.

Service under this warranty shall not be made available until such time as a properly completed, digitally signed, and the Installation/Warranty Registration has been received by GFE within 30 days from the date of installation. Complete warranty registration at: [www.globefoodequip.com/support/warranty-registration-form](http://www.globefoodequip.com/support/warranty-registration-form).

THE FOREGOING WARRANTY PROVISIONS ARE A COMPLETE AND EXCLUSIVE STATEMENT BETWEEN THE BUYER AND SELLER. GFE NEITHER ASSUMES NOR AUTHORIZES ANY PERSONS TO ASSUME FOR IT ANY OTHER OBLIGATION OR LIABILITY IN CONNECTION WITH SAID EQUIPMENT.

WARRANTY REGISTRATION  
GO TO [WWW.GLOBEFOODEQUIP.COM](http://WWW.GLOBEFOODEQUIP.COM)  
TO FILL OUT AND SUBMIT YOUR WARRANTY REGISTRATION.

[WWW.GLOBEFOODEQUIP.COM/SUPPORT/WARRANTY-REGISTRATION-FORM](http://WWW.GLOBEFOODEQUIP.COM/SUPPORT/WARRANTY-REGISTRATION-FORM)