

SANDWICH UNIT REFRIGERATOR

Model: SW48N10C-FB-D

Natural Refrigerant R-290 Model

48" Cutting Top Sandwich Unit Refrigerator with Drawers - 10 Pans Front Breathing

Stainless steel front, top and end panels, aluminum back and interior.



Options and Accessories

(upcharge and lead times may apply)

Stainless steel interior	Drawer locks
Stainless steel back	Rear mounted cutting board
Overshelves (single or double)	Composite cutting board
Flat lid	Modified pan opening
Vision panel lid	

Consult factory for other model configurations, options and accessories.

Project Name:

Model Specified:

Location:

Item No:

Quantity:

AIA #:

SIS #:

Standard Model Features

REFRIGERATION SYSTEM

Performance rated refrigeration system

Natural, environmentally safe, high efficiency R-290 refrigerant¹

Unique air flow distribution allows pan product to maintain 33° - 41°F

Automatic, hot gas condensate evaporator

Non-corrosive, plasticized fin evaporator coil

Easily serviceable, back mounted compressor

Expansion valve system

CABINET ARCHITECTURE

2" non-CFC polyurethane foam insulation

Smooth, polished chrome drawer handles

Stainless steel roll out drawers

Magnetic snap in Santoprene™ drawer gaskets

19" deep, full length nylon cutting board

Insulated lid

Completely enclosed, vented and removable case back

3 3/4" casters

MODEL FEATURES

(10) 1/6 size recessed pans, 4" deep

Electronic control, off-cycle defrost

Removable interior tub below pans

¹ R-290 refrigerant meets all federal and state regulatory requirements.

Front breathers are a unique, field assembled, bottom mounted ventilation system designed to allow cabinets to be flush against a wall or built into a counter to conserve space. For proper operation, the area under and in front of the cabinet must not be obstructed in any way.

Continental[®]
Refrigerator



APPROVAL:

Model Specifications

DIMENSIONAL DATA

Net Capacity (cubic feet)	13.4 (379 cu l)
1/6 Size Pans (4" deep)	10
Width, Overall (inches)	48 (1219 mm)
Depth, Overall (inches) (including cutting board & bumpers)	38 1/4 (972 mm)
Depth, Cutting Board (inches)	19 (483 mm)
Height, Overall (inches) (including 3 3/4" casters)	41 (1041 mm)
Number of Drawers	4

REFRIGERANT DATA

Condensing Unit Size (H.P.)	1/4
Capacity (BTU per hour)*	1940

ELECTRICAL DATA

Voltage (International)	115/60/1 (220/50/1)
Total Amps (International)	4.8 (2.7)
10 ft. Cord/Plug [attached] (International)	Yes (No)

SHIPPING DATA

Weight (pounds)	355 (162 kg)
Height - Crated (inches)	43 1/4 (1099 mm)
Width - Crated (inches)	56 (1422 mm)
Depth - Crated (inches)	37 1/4 (946 mm)

DRAWER PAN CONFIGURATIONS

Two Tier: (1) 1/2 size x 6 & (1) 1/3 x 6 pan per drawer

* Rating @ +25°F evaporator, 90°F ambient
Figures in parentheses reflect metric equivalents rounded to the nearest whole unit.



Equipped with one NEMA-5-15P Plug
(varies by country)

Continental
Refrigerator

Toll-Free: 800-523-7138
Phone: 215-244-1400
Fax: 215-244-9579

539 Dunksferry Road
Bensalem, PA 19020
www.continentalrefrigerator.com

Due to our continued efforts in developing innovative products, specifications subject to change without notice.



PROUDLY
DESIGNED & ASSEMBLED
IN THE U.S.A.

© Copyright 2021. Continental Refrigerator.
A Division of National Refrigeration & Air Conditioning Products, Inc.

Model Plan Views

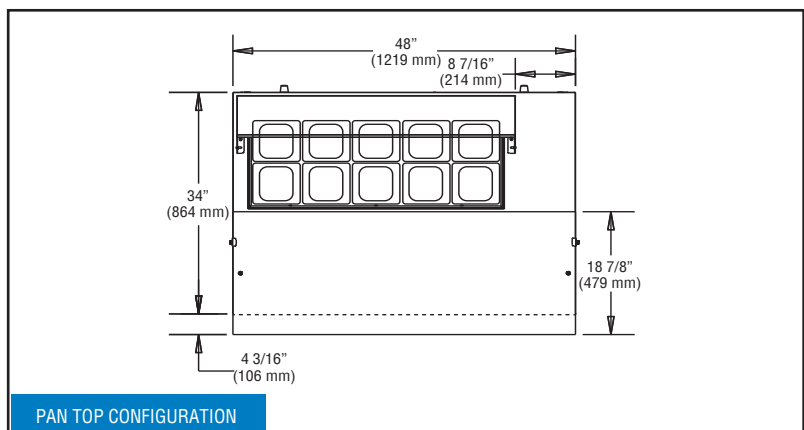
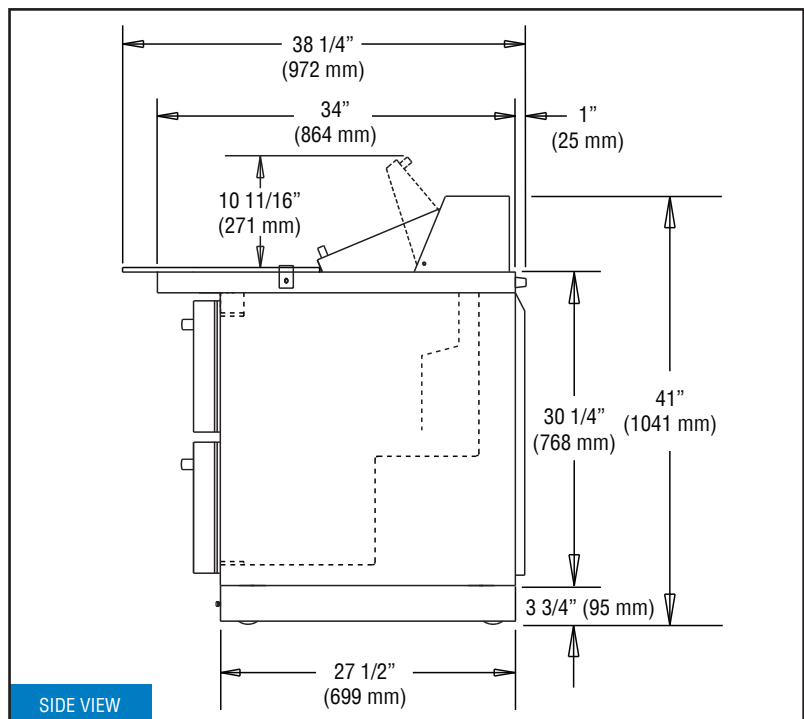
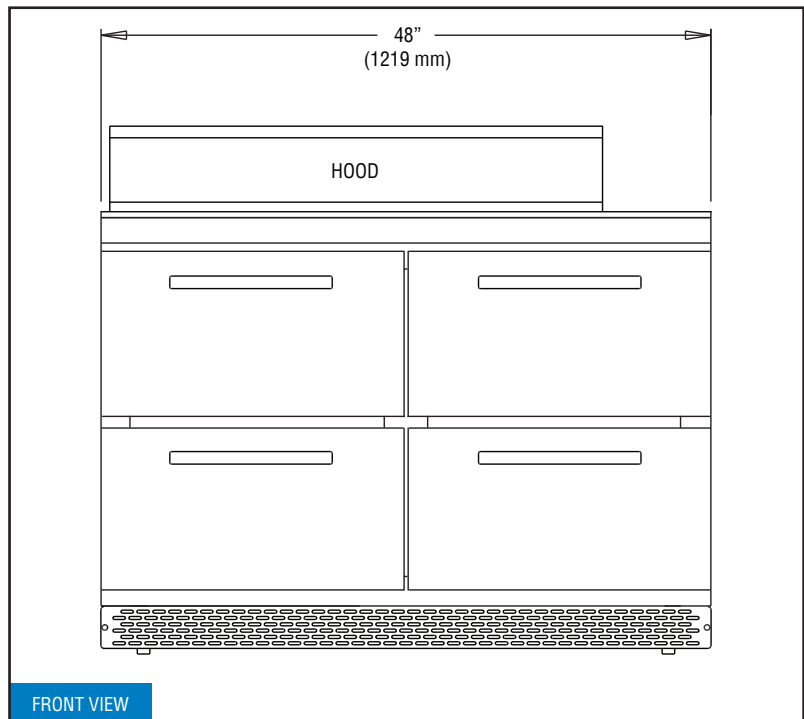

REVISED: 3/13/24