

CHP SERIES HOT PLATE

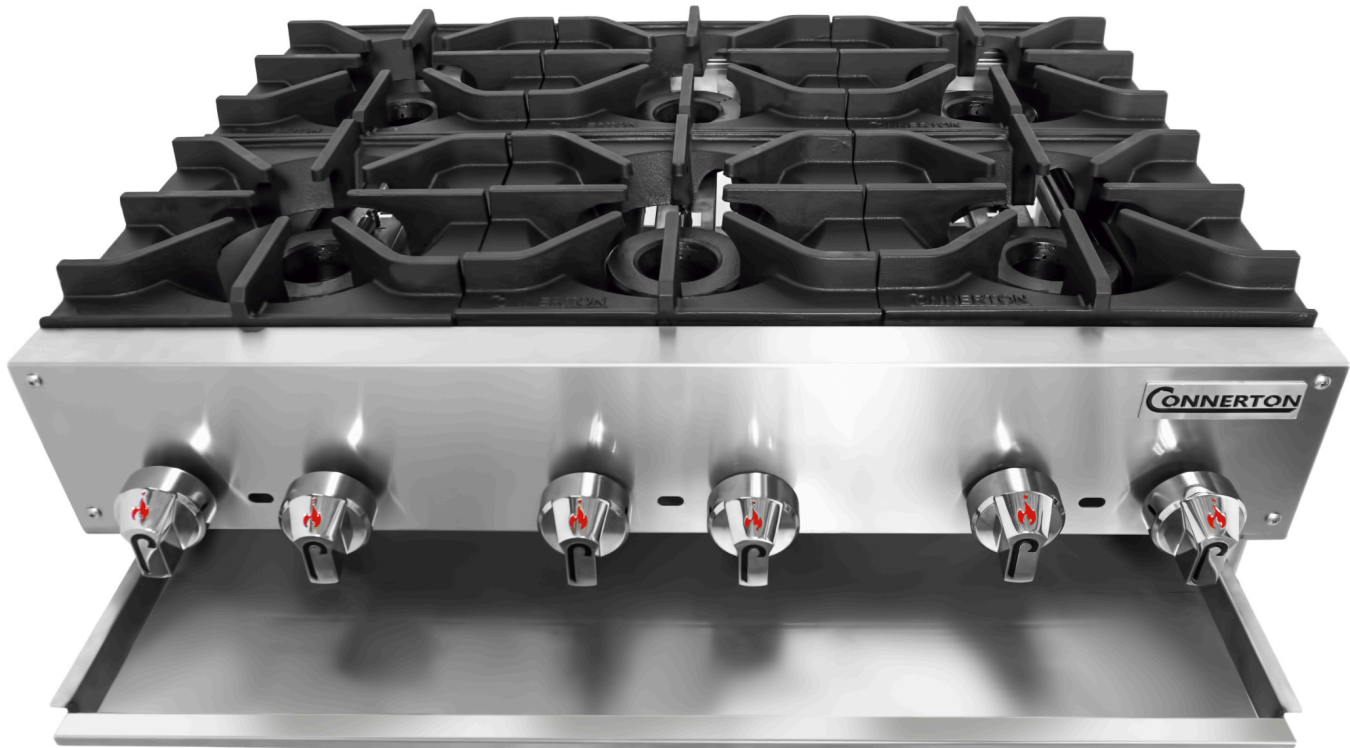

AVAILABLE IN TWO DEPTHS:
15" & 27"



WELDED #304 STAINLESS STEEL
For easy cleaning and long life



32,000 BTU BURNERS
Increased heat for faster cooking



AVAILABLE OPTIONS:





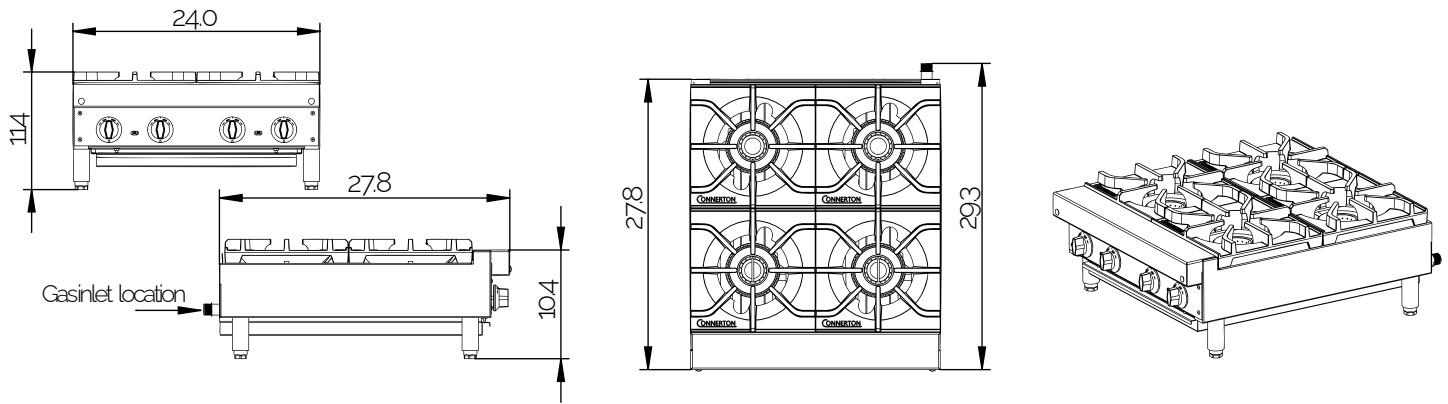



- Stainless Steel Plate Shelf (Custom Sized)
- Stainless Steel Wok Adapter Ring
- Lift-Off Griddle (12" & 24")
- 4" Legs Accessory
- Floor Model Accessory

FLOOR MODEL



MODEL	WIDTH	DEPTH	BTU	BURNERS	WT. (EST)*	WT. (EST)*
CHP-212	12"	27"	64,000	2	60	80
CHP-424	24"	27"	128,000	4	110	135
CHP-636	36"	27"	192,000	6	160	190
CHP-848	48"	27"	256,000	8	210	245
CHP-112	12"	15"	32,000	1	35	n/a
CHP-224	24"	15"	64,000	2	60	n/a
CHP-336	36"	15"	96,000	3	85	n/a
CHP-448	48"	15"	128,000	4	110	n/a

▶ PRODUCT SPECIFICATIONS:

 <p>BODY 18 Gauge #304 Stainless Steel, Fully Welded</p>	 <p>FRONT Removable 18 Gauge #304 Stainless Steel Panel</p>	 <p>GRATE Heavy Duty Painted Cast Iron w/ "Center-Slope" Hole</p>	 <p>BURNERS 32,000 BTU Heavy Duty Painted Cast Iron</p>	 <p>DRIP PAN 18 Gauge #304 Stainless Steel</p>
 <p>VALVES Heavy Duty Brass</p>	 <p>GAS INLET ¾ NPT</p>	 <p>GAS PRESSURE 5.0" Natural, 11.0" Propane (Inches Water Column)</p>	 <p>LEGS (FLOOR MODEL) Stainless Steel tubing With casters, Bullet, or seismic options</p>	

▶ NOTES:

- Gas Pressure Regulator is supplied and must be installed
- Combustible locations: 8" Clearance sides and back
- Non-Combustible Locations: 0" Clearance sides and back
 - Specify type of gas and altitude if over 2,000 feet

 Connerton reserves the right, without notice, to make changes and revisions in product specifications, materials and design, which in our opinion will provide better performance, durability and efficiency.