

Blueair by
BLUENIX

MODEL BLPT48-HC SANDWICH PREP TABLES



Stainless steel cabinet construction

Stainless steel interior and exterior (galvanized steel back & bottom).



Temperature range between 33°F ~ 39°F

Air guard on rear wall ensures proper air circulation and cooling.



Hydrocarbon refrigerants (R-290)

Increases energy HFC refrigerants. It is safer for the environment and does not cause ozone depletion.



Exterior Dimensions (inches/mm)

L	D	H
36 1/2"	30 3/64"	37 19/32"
703 mm	763 mm	955 mm

Weight (lbs/kg)

Net Weight	Ship Weight
223 lbs	289 lbs
101 kg	131 kg

* Depth does not include 3" for door handle & rear spacers
* Height does not include 5" (127 mm) for casters

Cabinet construction

- Cyclopentane Insulation – Contains no hydro-fluorocarbons (HFCs) and is environmentally friendly.
- Epoxy coated wire shelves with adjustable shelving height.
- Drop-in section : Fans force cold air into this enclosed area keeping stored food items consistently cold
- Insulated pan cover with a stainless steel divider which prevents food spillage into the storage area beneath
- Standard 1/6 / 4" food pans are provided. Unit accommodates 6" deep pans
- Side rail cutting board bracket with 9 1/2" deep, 1/2" thick cutting board included
- Four 4" Diameter swivel casters with front brakes standard.

Refrigeration

- Self-contained system, rear mounted compressor.
- Electrodeposition coated evaporator increases performance by maintaining the heat transfer rates over the life of the evaporator and reducing potential corrosion.
- Innovative hot gas frame heating system reduces condensation and increases energy.



Conforms to NSF/ANSI 7(ETL)



Front view

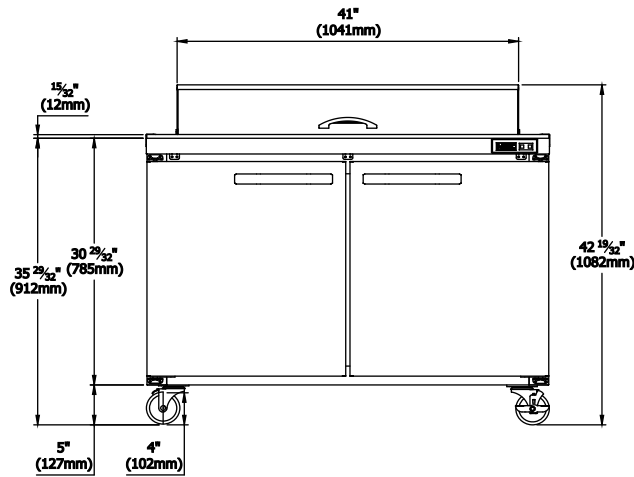

Side view

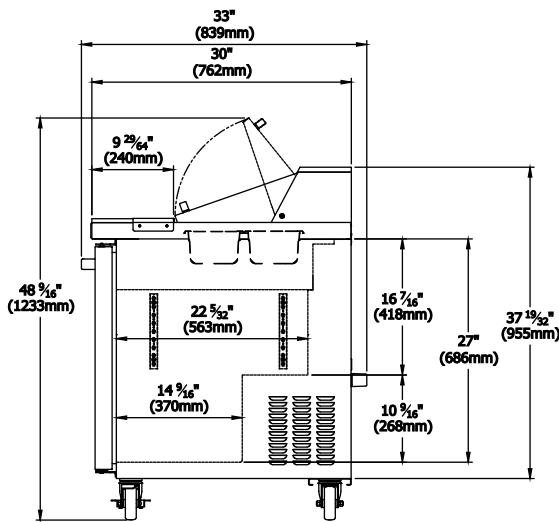

Top view

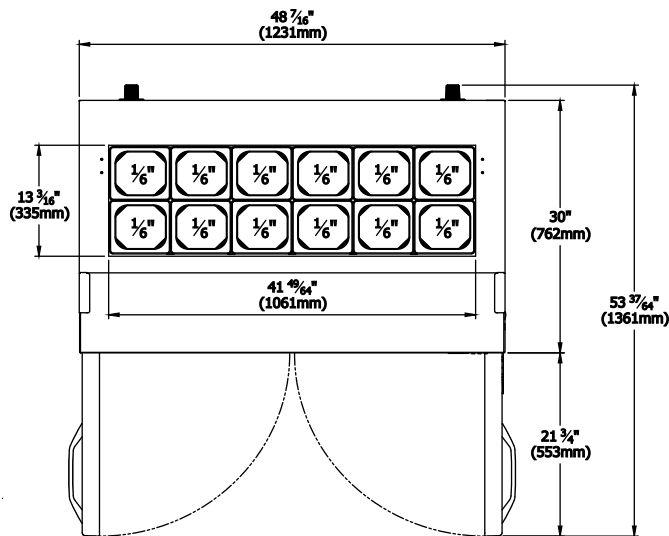

Doors

- Self-closing doors
- Durable door gasket with easy replacement.
- Lifetime guaranteed heavy duty all metal door handles. (Ni-Cr Plated)
- Door designed to open easily.

Design & Features

- Self-diagnostic digital temperature control & monitor system.
- Digital display allows for easy monitoring.
- Digital controls include automatic evaporator fan motor delay
- Rounded corner design gives a stylish appearance and reduces chances of injury.
- Visual and audible door open alarm, alarm sounds when doors are not completely closed to protect against food spoilage

Optional Features & Accessories

- 2.5" diameter casters available.
- Additional shelves are available.
- Drawer models available
- 6" pans available

Doors	2
Capacity Cu.Ft.	13.1
Shelves	2
Refrigerant	R-290
Temperature Range	33°F ~ 39°F
Easy Maintenance	Sliding Condensing Unit
Connection	9.8 ft long (3m) flexible three wire cord with molded plug
HP	1/4
Voltage	115V/60Hz
Amps	4.5
NEMA Config.	NEMA 5-15

Blue Air has right to change specifications without further notice.



- This product may expose you to chemicals including Diisononyl Phthalate(DINP), which is known to the State of California to cause cancer. For more information go to www.P65Warnings.ca.gov.
- Ce produit peut vous exposer à des agents chimiques incluant le Diisononyl Phthalate(DINP), reconnu par l'Etat de Californie comme causant le cancer. Pour de plus amples renseignements, consulter le site www.P65Warnings.ca.gov.



223 W. Rosecrans Ave., CA 90248
T: 310-808-0102

9 W. Shelton Terrace #A, Hillside, NJ 07205
T: 470-625-0182

7025 Amwiler industrial Drive, Suite A, Atlanta GA
T: 908-688-0970