



PROJECT: _____
 LOCATION: _____
 ITEM#: _____
 QUANTITY: _____



C-RWT44-HC



C-RWT67-HC



C-RWT93-HC

WORK TOP REFRIGERATOR

- Beautiful ergonomic construction & rounded corners
- Digital temperature controller and read-out
- All stainless steel exterior and interior
- Forced air refrigeration system
- Side mount compressor for enhanced efficiency
- Recessed door handles
- Pre-installed casters and shelving
- 90 degree hold open door feature for loading products
- Deep working surface with optional backsplash available
- Drawer models available. Order as an accessory
- All Natural R290 Hydrocarbon Refrigerant
- US Department of Energy Certified
- Migali® Protection Plan: 2 Year Parts & Labor Warranty, 5 Years Compressor Warranty

MODEL	DOORS	CAPACITY CU/FT	SHELVES	H/P	AMPS	VOLTAGE	ENERGY CONSUMPTION KWH/24 HR	PLUG TYPE	TEMP RANGE	EXTERIOR DIMENSIONS W X D X H**	INTERIOR DIMENSIONS W X D X H	PACKAGED DIMENSIONS W X D X H**	WEIGHT	PACKAGED WEIGHT
C-RWT44-HC	1	14	1	1/7+	2.3	115/60/1	1.5	Nema 5-15P	+33° F (-) +41° F	44 x 33 x 37.9	40.4 x 26.4 x 26.3	47 x 35 x 40	238 lbs.	295 lbs.
C-RWT67-HC	2	20	2	1/5	2.8	115/60/1	2.1	Nema 5-15P	+33° F (-) +41° F	67 x 33 x 37.9	63.5 x 26.4 x 26.3	68 x 35 x 40	335 lbs.	405 lbs.
C-RWT93-HC	3	26	3	1/4+	3.1	115/60/1	2.6	Nema 5-15P	+33° F (-) +41° F	93 x 33 x 37.9	89.4 x 26.4 x 26.3	95 x 35 x 40	427 lbs.	527 lbs.

** Height is measured floor to the top of the pan rail and include 6" casters

FOR COMMERCIAL USE ONLY

NOTE: MIGALI® RESERVES THE RIGHT TO CHANGE SPECIFICATIONS WITHOUT NOTICE



TOLL FREE: 800.852.5292
 WEB: www.migali.com



DIMENSIONAL DRAWINGS

C-RWT44-HC

C-RWT67-HC

C-RWT93-HC

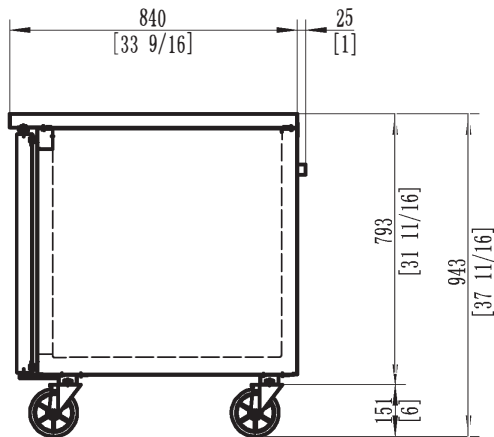
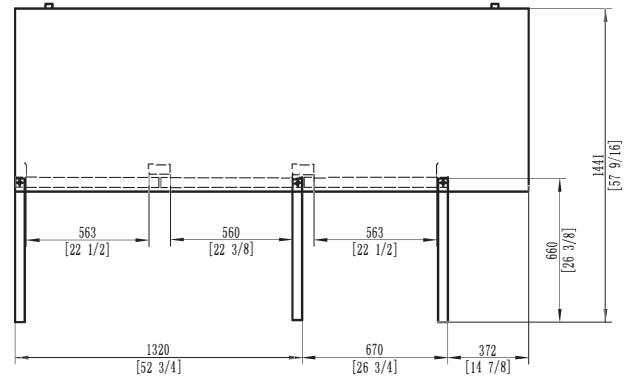
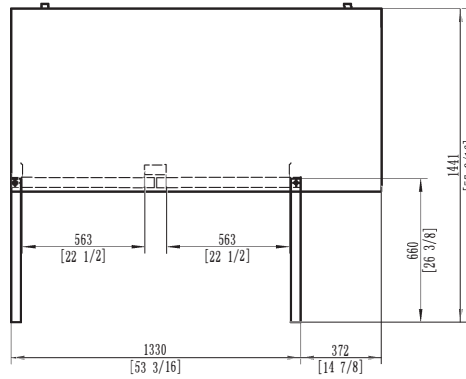
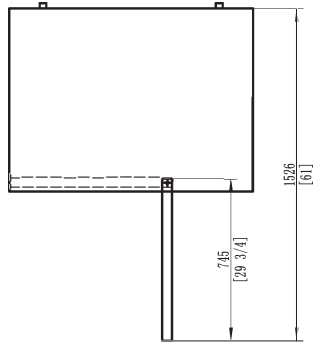
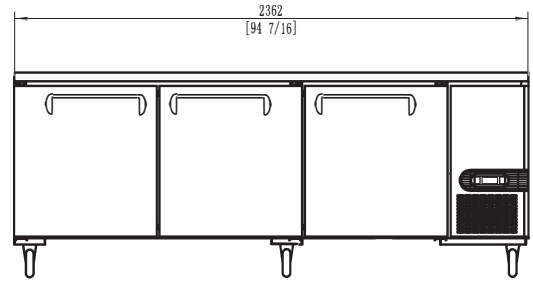
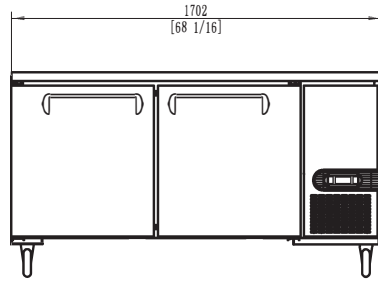
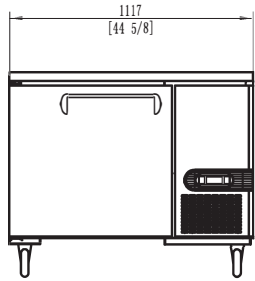

SIDE VIEW (1,2,3) DOOR MODELS



MIGALI® REMAINS AN AMERICAN FAMILY COMPANY SINCE 1955