

Champion®

The Dishwashing Machine Specialists

Project _____

Item No. _____

Quantity _____

PP-28

Pot, Pan, Utensil
Door Type
Washing Machine

STANDARD FEATURES

- **NEW** Factory authorized startup
- Balanced door system
- Detergent/chemical connection provisions
- Door safety switch on each door
- Enclosure panels (front and sides)
- External lift-out refuse basket
- Fully automatic wash and rinse cycle
- Hold-down grid
- 7.5-Hp drip-proof pump motor
- Interchangeable upper and lower wash and rinse arms
- Low water tank heat protection
- Recessed, front-mounted controls
- Six-inch diameter vent connection
- Electric wash tank heat
- Rack bake sheet
- Utility rack

OPTIONS & ACCESSORIES

- Corner Operation**
- Straight-through Operation**
- Front-loading Operation**
- Ten" Shelf** on front-loading machine
- Steam Coil** tank heat
- Steam Injector** tank heat
- Boosters, Stainless Steel** (completely interplumbed, controls are interwired)
 - Steam: 40°F Rise** (built-in) (externally mounted with cover for corner model)
 - Steam: 70°F Rise** (externally mounted with cover)
 - Electric: 40°F Rise** (built-in) (externally mounted with cover for corner model)
 - Electric: 70°F Rise** (externally mounted with cover)
- Exhaust Fan**, 1/3 Hp
- Racks, Stainless Steel** (5" x 28" x 28")
- NEW** Champion ION scale prevention system



Photo is for general visual representation only. Please refer to specifications for the latest detailed product information.



SPECIFIER STATEMENT

Specified unit will be Champion model PP-28 pot, pan, utensil door type washing machine.

Features adjustable wash cycle depending on solid wares from 2 to 5 minutes, revolving upper and lower high pressure spray arms, large wash chamber spacious enough to accommodate 140 quart mixing bowls, fully automatic operation, and made entirely of heavy gauge stainless steel from the base to spray arms. One year parts and labor warranty.

Champion Industries, Inc.
3765 Champion Blvd., Winston-Salem, NC 27105
Tel: 336/661-1556 Fax: 336/661-1979
www.championindustries.com

NOTE: ALL electric boosters require separate electrical connection.

Volume crated: **111 cu. ft.**
Shipping weight crated: **1100 lbs.**
Shipping weight crated with built-in booster: **1200 lbs.**

Dimensions shown in inches

Details, Dimensions & Connections

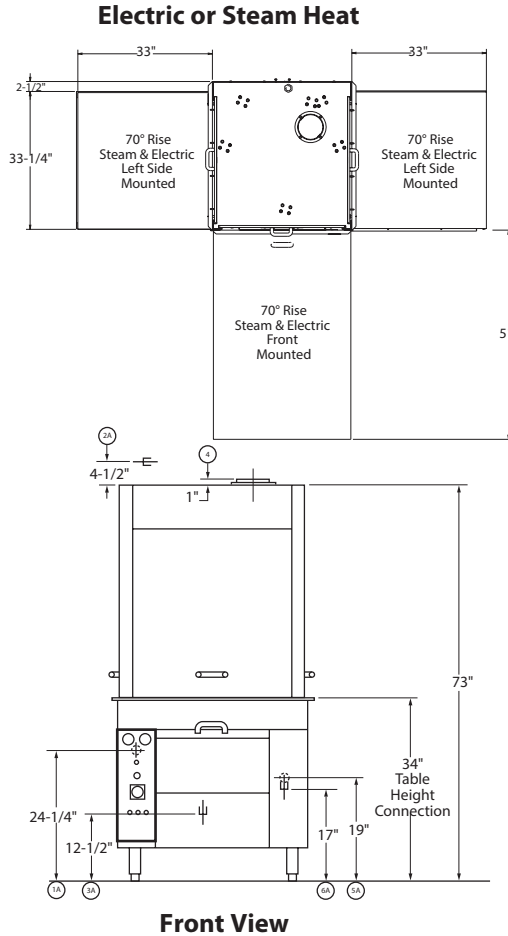
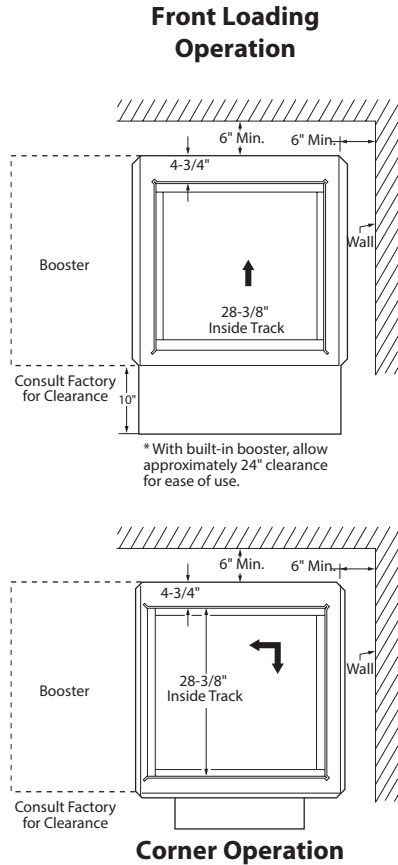

Typical Table Construction

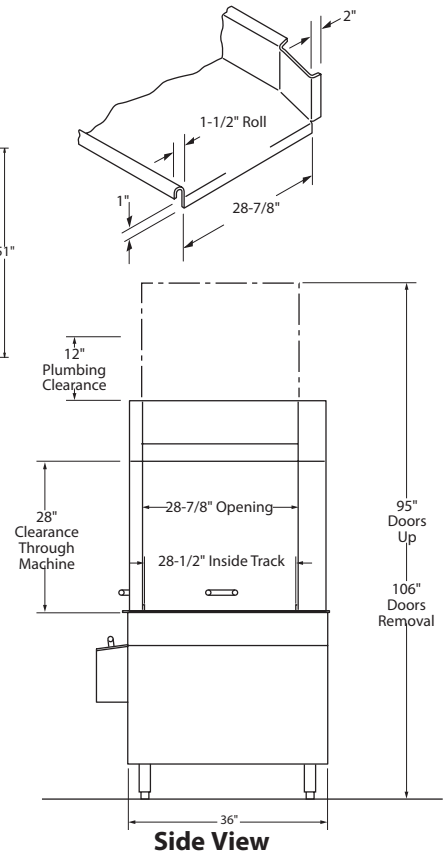

Warning: Plumbing and electrical connections should be made by qualified workmen who will observe all the applicable plumbing, sanitary, safety codes and the National Electrical Code.

Plumbing Notes: Because of the variation in house-supplied steam and water pressures, steam and water pressure regulating valves (PRVs) are needed (water PRV is standard on model with built-in booster). The PRVs can either be purchased from Champion or obtained locally.

Note: Water Hammer Arrestor (meeting ASSE-1010 standard or equivalent) to be supplied (by others) in common water supply line at service connection.

Machine Load Amps

Voltage	Electric Heat	Steam Heat	Electric Heat & Exhaust Fan	Steam Heat & Exhaust Fan
208/60/3	50	22	53	25
240/60/3	45	21	48	24
480/60/3	22	11	24	13

Utilities

1 Electrical

A See box (1) for machine connection.
B See box (2) for separate built-in 27 kW electric booster connection.

2 Hot Water

A 1" NPT 180°F connection. Flow pressure 20-22 psi/82.5 gph @ rate of usage 13.5 gpm
B 1" NPT 140°F connection. Flow pressure 20-22 psi/82.5 gph. Unmounted water PRV provided.

3 Drain

A 1-1/2" NPT connection. Maximum flow 15 gpm.
B 3/4" NPT steam booster relief to open drain.

4 Vent

6" diameter. 200 CFM. (Contact the factory for optional exhaust fan connections.)

5 Steam

A 3/4" NPT connection. Flow pressure 15-30 psi. (Tank heat only).
B 1-1/4" NPT connection (Tank & Booster 40° rise).
2" NPT connection (Tank & Booster 70° rise). *Consult factory for location*

6 Condensate

A 1/2" NPT machine connection return to boiler (steam coil heat only).
B 3/4" NPT machine connection return to boiler (steam heat, steam booster).

Due to an ongoing value analysis program at Champion, specifications contained in this catalog are subject to change without notice.

Champion Industries, Inc., 3765 Champion Blvd., Winston-Salem, NC 27105 • 336/661-1556 • Fax: 336/661-1979 • www.championindustries.com

PP-28

Pot, Pan, Utensil
Door Type
Washing Machine

ACCESSORIES

- | | |
|---|------------|
| <input type="checkbox"/> Rack Basket
(utensils and loose items) | P/N 109584 |
| <input type="checkbox"/> Rack Pan
(baking pans) | P/N 109585 |
| <input type="checkbox"/> Rack Bake Sheet
(baking sheets) | P/N 109587 |
| <input type="checkbox"/> Rack Utility
(large pots and pans) | P/N 109586 |

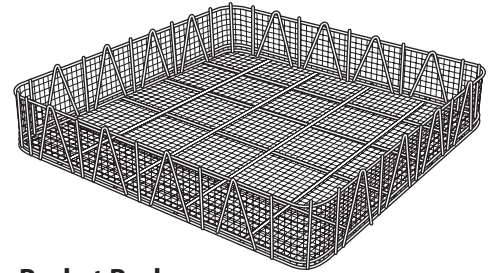

Basket Rack

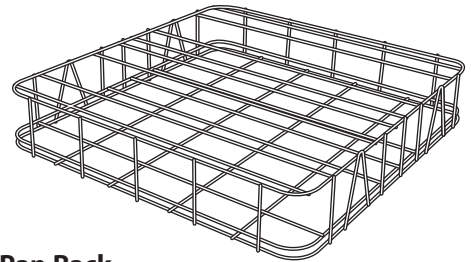

Pan Rack

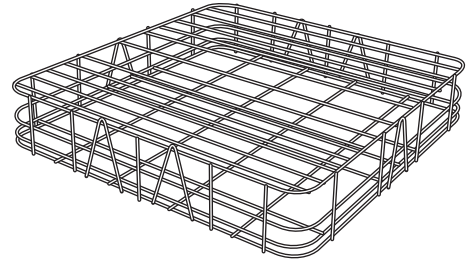

Bake Sheet Rack

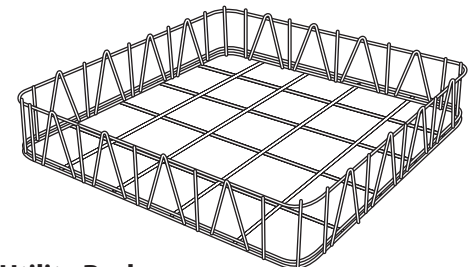

Utility Rack

Due to an ongoing value analysis program at Champion, specifications contained in this catalog are subject to change without notice.

Champion Industries, Inc.,
3765 Champion Blvd., NC 27105
336/661-1556 • Fax: 336/661-1979
ChampionIndustries.com