

DESIGNER LINE SANDWICH UNIT

Model: D48N12-D

Natural Refrigerant R-290 Model



48" Standard Top Sandwich Unit Refrigerator with Drawers - 12 Pans

Stainless steel front, top and end panels and interior.



Options and Accessories

(upcharge and lead times may apply)

Stainless steel back	Rear mounted cutting board
Overshelves (single or double)	Composite cutting board
Drawer locks	Flat insulated night cover
Crumb catcher	Vision panel lid
Casters	Modified pan openings
Front breathing	

Consult factory for other model configurations, options and accessories.



Project Name:

Model Specified:

Location:

Item No:

Quantity:

AIA #:

SIS #:

Standard Model Features

REFRIGERATION SYSTEM

Performance rated refrigeration system

Natural, environmentally safe, high efficiency R-290 refrigerant¹

Unique air flow distribution allows pan product to maintain 33° - 41°F

Automatic, hot gas condensate evaporator

Non-corrosive, plasticized fin evaporator coil

Expansion valve system

Easily serviceable, back mounted compressor

CABINET ARCHITECTURE

2" non-CFC polyurethane foam insulation

Smooth, polished chrome drawer handles

Stainless steel roll out drawers

Magnetic snap in Santoprene™ drawer gaskets

12" deep, full length nylon cutting board

Insulated lid

Completely enclosed, vented and removable case back

6" adjustable, stainless steel legs

MODEL FEATURES

Electronic control, off cycle defrost

(12) 1/6 size recessed pans, 4" deep

Removable interior tub below pans

¹ R-290 refrigerant meets all federal and state regulatory requirements.

APPROVAL:

Model Specifications

DIMENSIONAL DATA

Net Capacity (cubic feet)	13.4 (379 cu l)
1/6 Size Pans (4" deep)	12
Width, Overall (inches)	48 (1219 mm)
Depth, Overall (inches) (including handles & bumpers)	32 3/16 (818 mm)
Depth, Cutting Board (inches)	12 (305 mm)
Height, Overall (inches) (including 6" legs)	43 1/4 (1099 mm)
Number of Drawers	4

REFRIGERANT DATA

Condensing Unit Size (H.P.)	1/4
Capacity (BTU per hour)*	1940

ELECTRICAL DATA

Voltage (International)	115/60/1 (220/50/1)
Total Amps (International)	4.8 (2.7)
10 ft. Cord/Plug [attached] (International)	Yes (No)

SHIPPING DATA

Weight (pounds)	405 (184 kg)
Height - Crated (inches)	43 1/4 (1099 mm)
Width - Crated (inches)	56 (1422 mm)
Depth - Crated (inches)	37 1/4 (946 mm)

DRAWER PAN CONFIGURATIONS

Two Tier: (1) 1/2 size x 6 & (1) 1/3 x 6 pan per drawer

* Rating @ +25°F evaporator, 90°F ambient

Figures in parentheses reflect metric equivalents rounded to the nearest whole unit.



Equipped with one NEMA-5-15P Plug
(varies by country)

Continental
Refrigerator

Toll-Free: 800-523-7138
Phone: 215-244-1400
Fax: 215-244-9579

539 Dunksferry Road
Bensalem, PA 19020
www.continentalrefrigerator.com

Due to our continued efforts in developing innovative products, specifications subject to change without notice.



PROUDLY
DESIGNED & ASSEMBLED
IN THE U.S.A.

© Copyright 2021. Continental Refrigerator.
A Division of National Refrigeration & Air Conditioning Products, Inc.

Model Plan Views

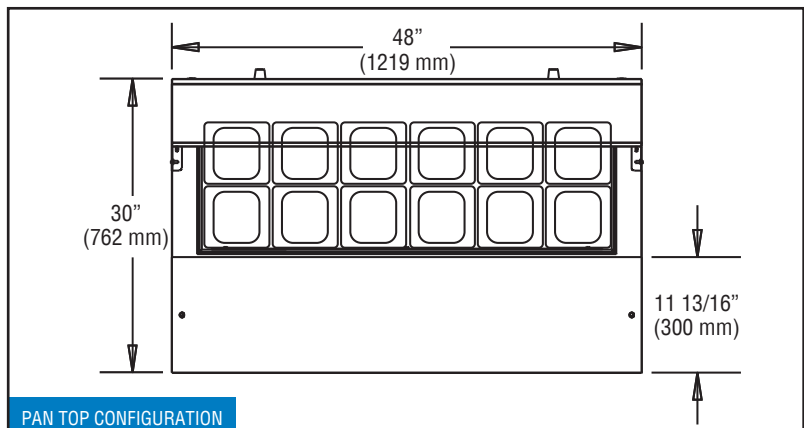
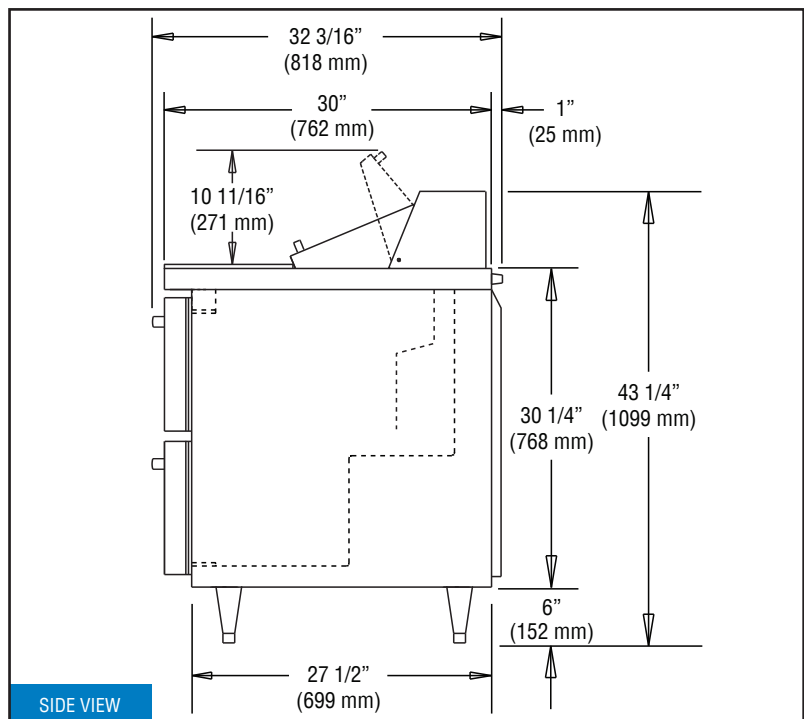
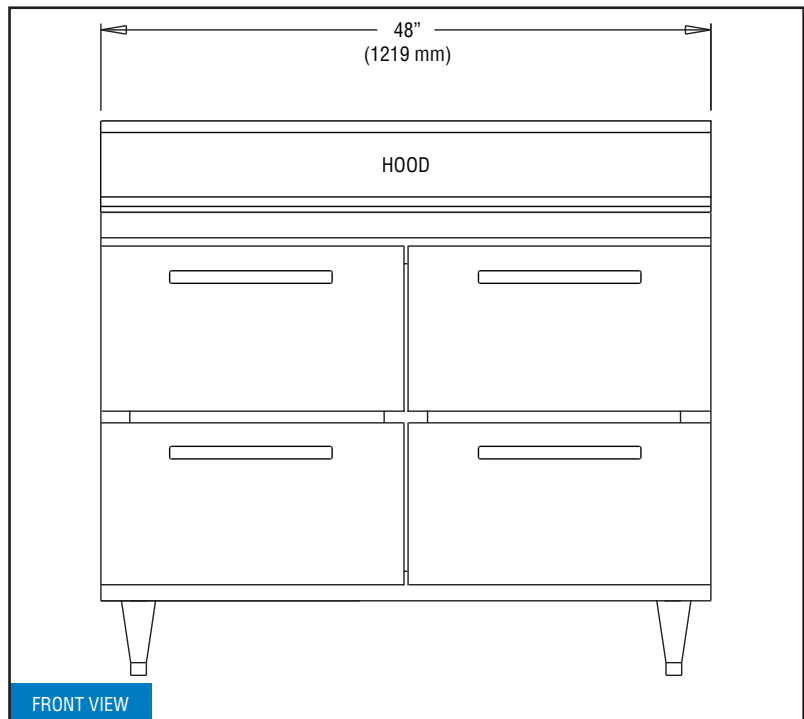

REVISED: 6/9/2024