

ASTRA QUICK SHIP WALK-IN COOLERS AND FREEZERS

- ✓ Walk-In Coolers, Freezers and Combos in stock
- ✓ Standard or Custom sizes ship within 48 hours
- ✓ Modular design with all cam-lock panels
- ✓ Wide range of sizes from 5' to 40'
- ✓ Top-Mount or Remote Refrigeration
- ✓ NSF, UL, DOE, ASTM Test 518, ASTM Test E84, UL723 Flame Spread and Smoke Development Compliant



STANDARD FEATURES

PANELS



PU Panels

- 4" Thick Foamed-In-Place Polyurethane Insulation
- Cam-Lock Panels, Tongue & Groove Design
- 24 Gauge Pre-Painted White Galvanized Steel
- R28 for Coolers and R33 for Freezers
- CFC and HFC Free Materials
- 10 year panel warranty

DOORS



30" or 36" wide doors

- 30" or 36" wide doors (left or right hinged)
- Self-Closing, Flush-Mounted Doors
- Keyed Locking Door Handle
- 120V/1P/1A Heating Wire and Pressure Relief Vent on Freezers



Keyed Locking Door Handle



Door Closer



Door Hinge



Vapor Proof Light

ADDITIONAL OPTIONS



4 FT LED Light



Exterior Ramp



Aluminum Diamond Plate



Kick Plate

TOP-MOUNT REFRIGERATION (PACKAGE UNIT)

- Self-Contained Package (Includes Condensing Unit and Evaporator)
- Cooler and Freezer available
- Indoor or Outdoor
- 208V/1P or 3P, Hard Wire, R448A
- 2 Year Compressor and Parts Warranty
- 1 Year Labor Warranty
- NSF and UL Listed, EPA Registered
- No need for Refrigeration Technician



REMOTE REFRIGERATION

- Includes Condensing Unit and Evaporator
- Cooler and Freezer available
- 208V/1P or 3P, Hard Wire
- 1 Year Compressor and Parts Warranty
- Pre-mounted Expansion Valve and Solenoid Valve
- Indoor or Outdoor
- Requires a Refrigeration Technician to run pipes and make connections



SPEC SHEET

CWF10X13 COOLER WITH FLOOR (9'-10" x 13'-1" x 7'-7"H)

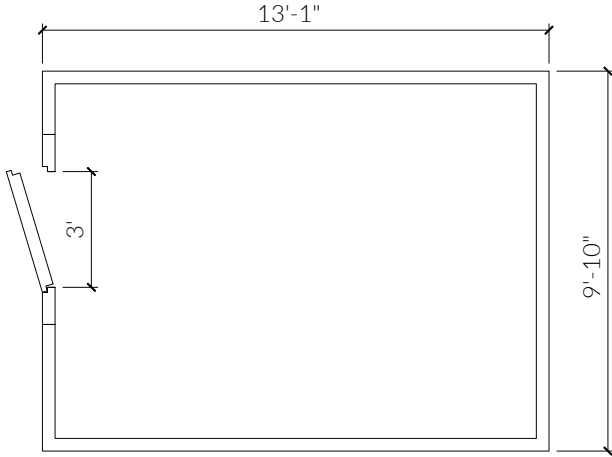

CWF10X13-1A

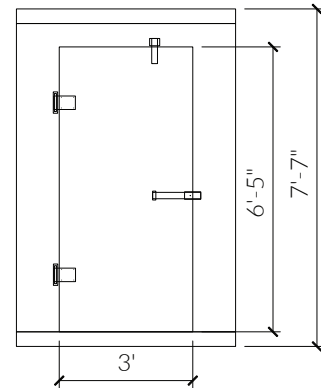

36" WIDE DOOR

- Doors can be right or left hinged.

Please select layout:

Alternative Layout Options

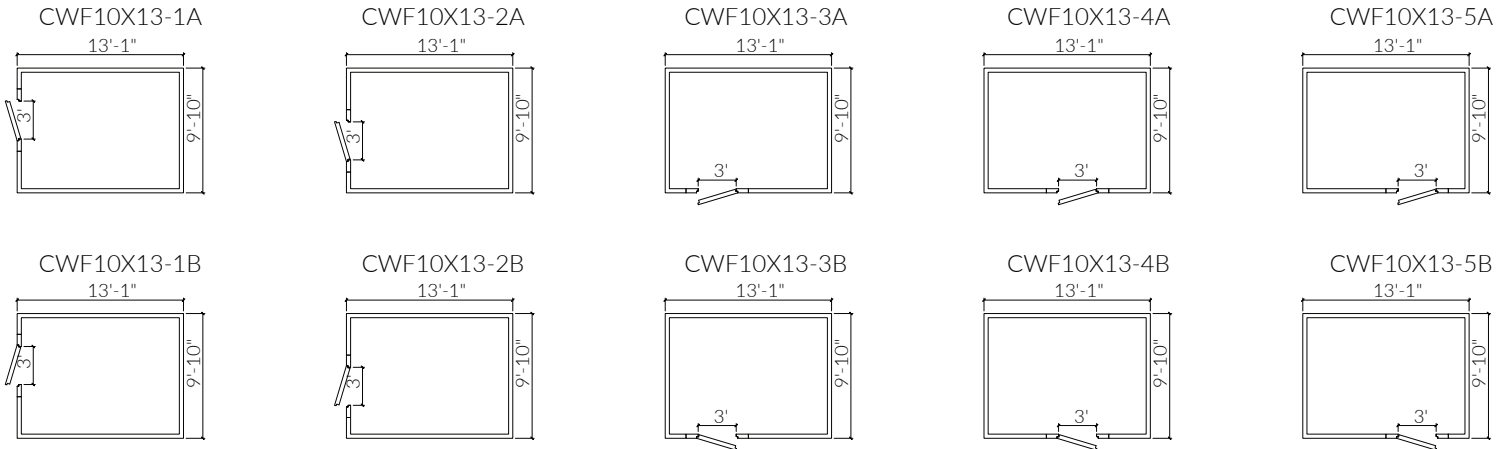

Please select options:

Door Options

- Narrow Door: 30" x 77"
- Standard Door: 36" x 77"

Hinge Options

- Right Hinge
- Left Hinge

Refrigeration Options

- Box Only
- Remote
- Top-Mount

Additional Options

- 4 FT LED light
- Exterior Ramp
- Aluminum Diamond Plate
- Kick Plate

CUSTOMER APPROVAL

DATE: _____

NAME: _____

SIGNATURE: _____