

**MODEL: IUC-UC27RCR / IUC36RCR
 IUC-UC48RCR/IUC-UC60RCR / IUC-UC72RCR**

**UNDERCOUNTER:
 Refrigerators**



IUC-UC27RCR



IUC-UC48RCR

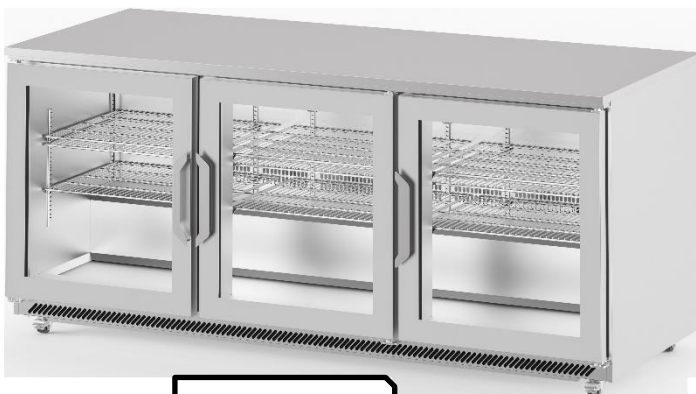

IUC-UC72RCR

GENERAL FEATURES

- ✓ **Higher energy efficiency.** R290 refrigerant with electric fans and evaporative tray without electric resistances.
- ✓ **Sanitation.** The interior cabinet is built for easy cleaning. Quick ability to take off shelves and slides for interior cleaning.
- ✓ **Doors.** Self-closing door system with permanent pressure. Stay open feature included when door remain open after 95 degrees. All doors include triple chamber door gaskets, easy to remove and shap in.
- ✓ **Control System.** Greater ability for the adjustment of temperature range as per the end user’s requirements.
- ✓ **100% Tested.** All condensing units undergo rigorous testing in helium chambers for refrigerant leak detection and a final equipment test in a state-of-the-art test room.
- ✓ **Certified.** Audited and Certified by INTERTEK for compliance with UL 471 and NSF 7.



**MODEL: IUC-UC27RCR / IUC36RCR/
 IUC-UC48RCR/IUC-UC60RCR / IUC-UC72RCR**

**UNDERCOUNTER:
 Refrigerators**

STANDARD FEATURES

➤ **Exterior**

- AISI 304 Stainless Steel Top.
- AISI 430 Stainless Steel.

➤ **Interior**

- AISI 430 Stainless Steel.

➤ **Door**

- Polyurethane insulated door.
- Self-closing door with stay open feature.
- Stainless Steel heavy-duty hinges.
- Triple chamber snap in door gaskets for easy removal and cleaning.
- Field reversible door (parts not included).
- Full-height door opening: 23-1/4" x 21-7/8" (590x555 mm).

➤ **Insulation**

- CFC- Free polyurethane insulation, entire cabinet structure is foamed-in using a high-density polyurethane insulation.
- Low GWP & Zero ODP effect.

➤ **Casters**

- 2" Diameter casters already installed.
- Locks provided on front set.

➤ **Shelving**

- (2/4/4/4/6) Plastic coated wire shelves.
- Set of Stainless- Steel shelf brackets.
- Easy remove for cleaning.
- Dimensions WxD: 22-1/4" x 17" (GN2/1) (565x432 mm).

➤ **Refrigeration**

- Temperature regulated by thermostatic control.
- Energy- saving non-electric condensate pan.
- Evaporator coil coated with anti-corrosion material 100% polyester.
- Forced air refrigeration system.
- Electric fans.
- **Refrigeration capacity:**
 IUC-UC27RCR -1263 Btu/h(14°F)/ 370 W(-10°C).
 IUC-UC36RCR - 2120 Btu/h(14°F)/ 443 W(-10°C).
 IUC-UC48RCR - 2120 Btu/h(14°F)/ 443 W(-10°C).
 IUC-UC60RCR -3427 Btu/h (14°F) / 443 W(-10°C).
 IUC-UC72RCR - 3427 Btu/h (14°F) / 621 W(-10°C).

➤ **Electrical**

- Cord and NEMA 5-P plug,
- Electrical connection is 115V / 1ph / 60 Hz.
- 15 AMP breakers required.



OPTIONAL FEATURES

- ✓ Drawer kit, compatible with: 12"x20" pans (GN1/1) (pans not included).
- ✓ Electrical connection is 230 V / 1 ph / 50 Hz (Plug type varies).
- ✓ Single overshelf kit.
- ✓ Double overshelf kit.
- ✓ 4" backsplash.
- ✓ Set of 2" diameter casters, with lock provided on front set.

➤ **ETL Listed to UL471 Standard and Sanitation classified to NSF7.**

**MODEL: IUC-UC27RCR / IUC36RCR /
 IUC-UC48RCR / IUC-UC60RCR / IUC-UC72RCR**

**UNDERCOUNTER:
 Refrigerators**

ELEVATION

PLANT VIEW

RIGHT VIEW

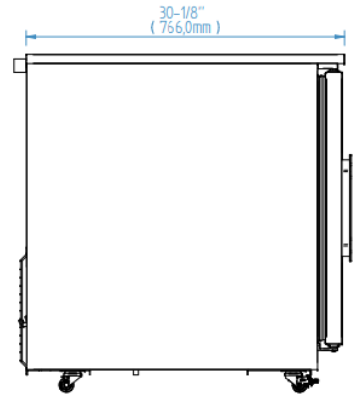
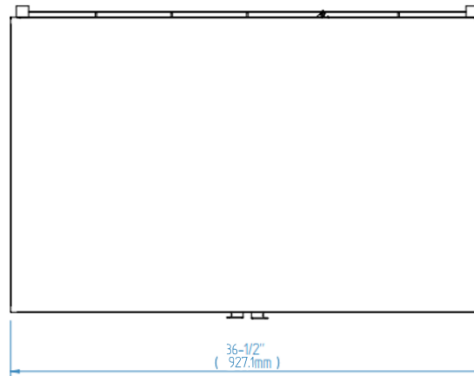
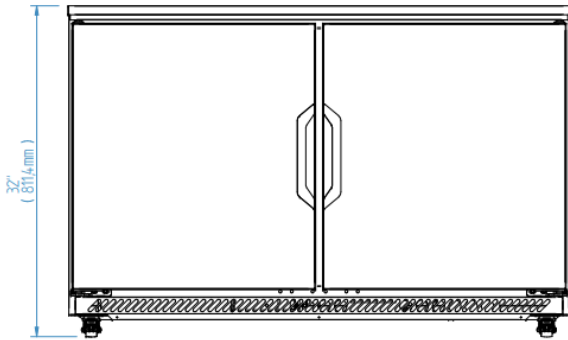

IUC-UC36RCR

ELEVATION

PLANT VIEW

RIGHT VIEW

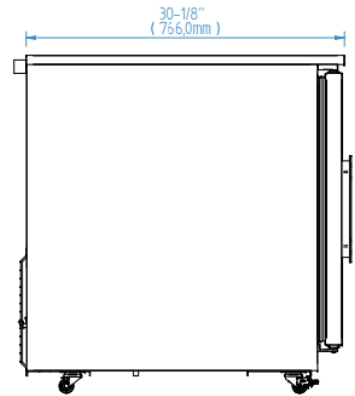
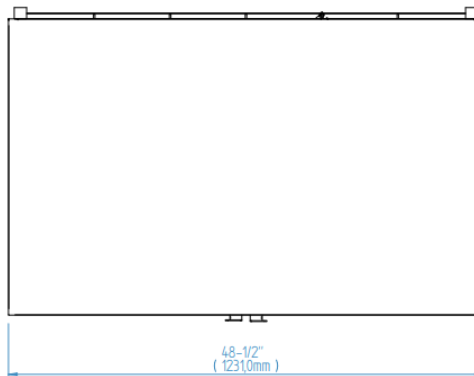
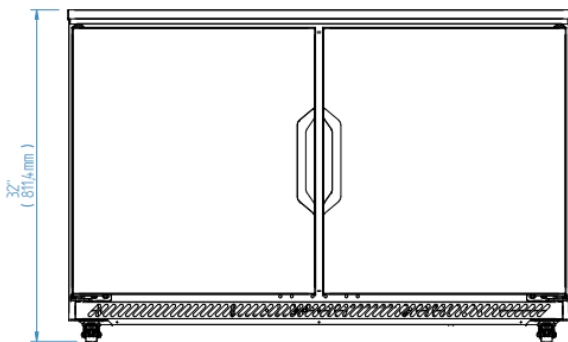

IUC-UC48RCR

ELEVATION

PLANT VIEW

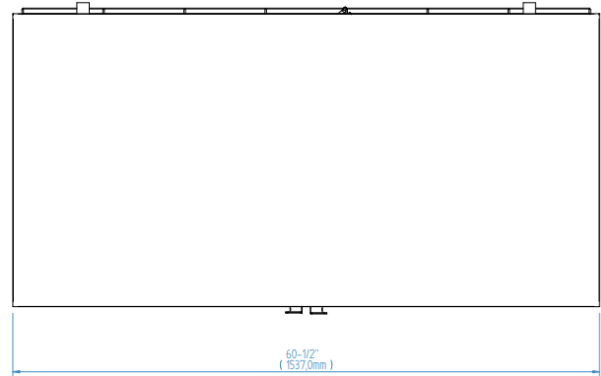
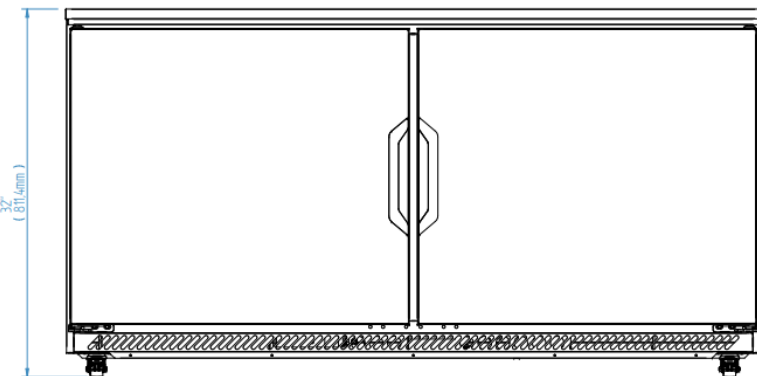

ETL LISTED TO UL471 STANDARD AND SANITATION CLASSIFIED TO NSF7 – WE RESERVE THE RIGHT TO CHANGE SPECIFICATIONS WITHOUT PRIOR NOTICE



INFRICO-North America Corporate División
 1409NW 84th Avenue, Doral FL 33126
 (305) 777 9599 ext.700 / f (305) 777 9598
 Toll Free 855-340-4637

www.infrico.us
sales@infrico.com

**MODEL: IUC-UC27RCR / IUC36RCR /
 IUC-UC48RCR/IUC-UC60RCR / IUC-UC72RCR**

**UNDERCOUNTER:
 Refrigerators**

RIGHT VIEW

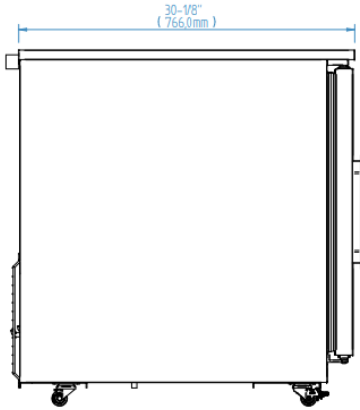

IUC-UC60RCR

ELEVATION

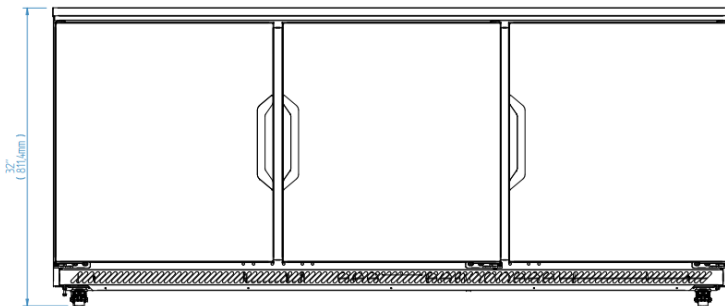

PLANT VIEW

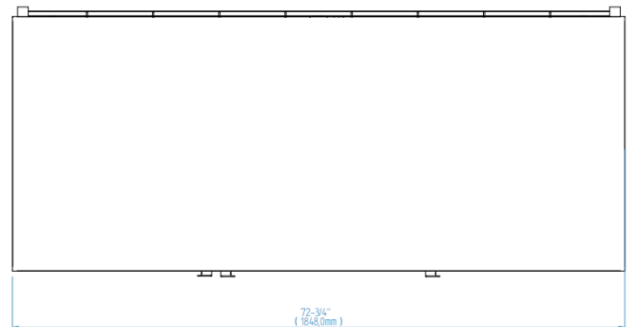

RIGHT VIEW

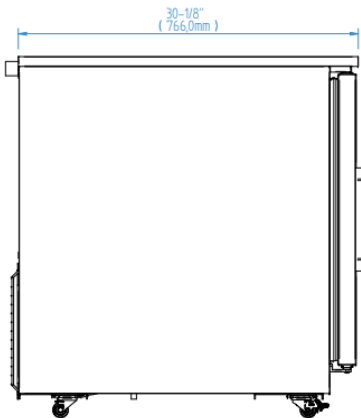

IUC-UC72RCR