

A hand in a white chef's coat holds a silver spoon, from which a vibrant red sauce is dripping. Below, a black plate features a fresh salad with green basil, sliced peaches, and bread. The background is a blurred kitchen setting.

EVEREO

EVEREO®
RECIPE BOOK

SERVICE TEMPERATURE
FOOD PRESERVING

EXEVER

PREFACE

SERVICE TEMPERATURE FOOD PRESERVING REVOLUTION

Are we sure that the cold chain is the only way to preserve food?

Now you can discover a whole new way to preserve your cooked food thanks to Evereo®, **the first hot refrigerator that takes advantage of the food preservation at service temperature technology.** It allows you to cook, preserve and consume the hot food also after many hours, without the need to cool it down to low temperatures and warming it up later, thus saving time and energy.

In this recipe book, we collected **30 recipes** to **guide you through the new food preservation world.** Join the revolution thanks to this complete guidebook to use your Evereo® at its best: it will be your best ally in the kitchen.





CONTENT

The revolution starts now: Food preservation
at service temperature and Evereo®

page 6

The technique

page 8

General principles

page 10

Food

page 12

Preservation mode

page 14

MULTI.Day mode

page 16

MULTI.Day Hot Vacuum

page 18

MULTI.Day Bags

page 22

Superholding mode

page 28

MULTI.Day: Preparations and Recipes

page 32

Superholding: Guidelines

pag 96

Recipes summary

pag 122

mealmefood.com

pag 124

REVOLUTION STARTS NOW

EVEREO®, THE FIRST HOT REFRIGERATOR

The revolution has taken its shape and now it has a name: Evereo®.

Evereo® is a unique product that, thanks to the Service Temperature Food Preserving innovative technique, can preserve cooked meals for days at service temperature.

Taking advantage of the science on which food preservation at service temperature is based, Evereo® safely preserves cooked meals for days at temperatures above 140 °F / 60 °C, putting together precise climate and temperature control and management.



SERVICE TEMPERATURE FOOD PRESERVING

Service Temperature Food Preserving is the new innovative technique that lies behind the Evereo® technology.

Evereo® working temperature is always above the threshold where pathogenic bacteria live, therefore it assures food safety.

Preserving food inside Evereo® more than 8 hours guarantees its pasteurization, even when you had previously cooled it down at 37 °F / 3 °C. Several tests, carried out in independent laboratories, demonstrated the advantages of this technology as for microbiological safety, preservation of the organoleptic properties of foods and savings in terms of time, energy and manpower.

SERVICE TEMPERATURE FOOD PRESERVING: THE TECHNIQUE

BEFORE PRESERVATION

When you prepare the food, temperature, time and the order in which operations are made during the cooking process can positively or negatively influence the preservation result.

THE ESSENTIALS

Besides Evereo® (01.), to preserve food at service temperature, you will need also:

- 02. A CHEFTOP MIND.Maps™ combi oven
- 03a. Vacuum bags that can be suitable for Service Temperature Food Preserving: MULTI.Day Bags
- 03b. Vacuum trays and lids for hot food preservation: MULTI.Day Trays
- 04. Oxygen extraction system: MULTI.Day Hot Vacuum

01.

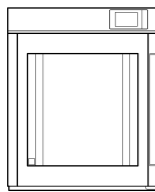

02.

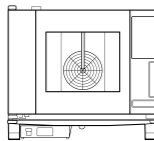

03a.



03b.



04.

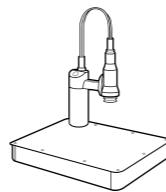

FOOD SAFETY

If food is “safe” just after it has been cooked, it will be even safer after the preservation process, thanks to the temperatures at which Evereo® preserves it. As a matter of fact, **food preservation at service temperature activates a long, low temperature pasteurization process** that increases food safety.

Should the product inside the hermetically sealed box accidentally cool down, due to a lack of electrical supply or because it remained outside Evereo® for an extended period of time, it will be sufficient to preserve it for some hours to re-activate the pasteurization process. (Note: the whole content of the box has to stay at more than 140 °F / 60 °C for at least 4 hours to make the pasteurization effective)

SUGGESTIONS

1. If the service won't start within 4 hours from the beginning of the preservation process, it is recommended to **cook food a little less** than usual before preserving it.
2. To have a texture contrast between the external and internal part of the food or, generally speaking, if you want to make food crunchy before serving it, it is recommended to **finish the dish in a convection oven** at high temperature (> 356 °F / 180 °C) for some minutes.

⚠ It is a good practice in the kitchen to **throw away everything that has a dubious colour or smell.**



SERVICE TEMPERATURE FOOD PRESERVING: GENERAL PRINCIPLES



01. During the preservation with Evereo®, **chemical-physical transformations related to the cooking process continue to take place**, but very slowly. Different more or less pleasant aromas can arise, textures can change and very often colours tend to darken.
02. Controlling the **temperature is essential** to obtain a good preservation result. Preserving food for 36 hours at a temperature which is one degree higher or lower than the ideal one corresponds to cooking for 30 minutes at a temperature which is tens of degrees higher or lower than the ideal one. That is why Evereo® is equipped with a technology that allows to maintain uniform and steady temperature during the whole preservation process.
03. The choice of the preservation temperature for animal products rich in connective tissues has to be made on the basis of the **texture** that you want to achieve, how cooked the food is before preservation and **how much time** you want to preserve it.
04. Generally speaking, all products that have to be cooked for **more than 30 minutes** or with a **core temperature above 149 °F / 65 °C** are suitable to be preserved at service temperature.
05. Food **preservation** at service temperature **increases the sapidity** of food, therefore it is recommended to use less salt when preparing food that needs to be preserved for more than 8 hours.
06. Sometimes, different **components** of the same dish **have to be preserved separately** and assembled later, when you serve it.

62 / 144
°C / °F



PASTA

Traditional pasta has to be preserved at **144 °F / 62 °C**, but you need to be aware that it will lose its “al dente” texture quite rapidly. Gluten-free pasta, instead, can be well preserved for many hours.



FOOD OF ANIMAL ORIGIN

Generally speaking, **food of animal origin** rich in connective tissues is really suitable to be preserved at a service temperature of **144 °F / 62 °C**.



RICE AND CEREALS

Rice can be preserved but you need to **separate it from its gravy**. It is recommended to add a little oil - or another fat - to prevent the grains from sticking together.



FISH

Fish can generally be well preserved when it is **humid** (long cooking) and has to be preserved together with its gravy.

70 / 153
°C / °F



LEGUMES

Legumes can be preserved together with the liquid they are submerged in and must be kept at **158 °F / 70 °C** otherwise they will acidify.



BREAD

Bread can be preserved at **158 °F / 70 °C**. In case of medium or long term preservation - starting from 8 hours - the crusts tends to become softer.



VEGETABLE SOUPS AND BROTH

Vegetable soups can be preserved with an **homogenization** effect on their flavours. Reactivate the contrast adding fresh ingredients (oil, pepper, parsley, etc.) before serving.

FOOD THAT FACILITATES PRESERVATION



FOOD THAT HAS TO BE AVOIDED DURING PRESERVATION

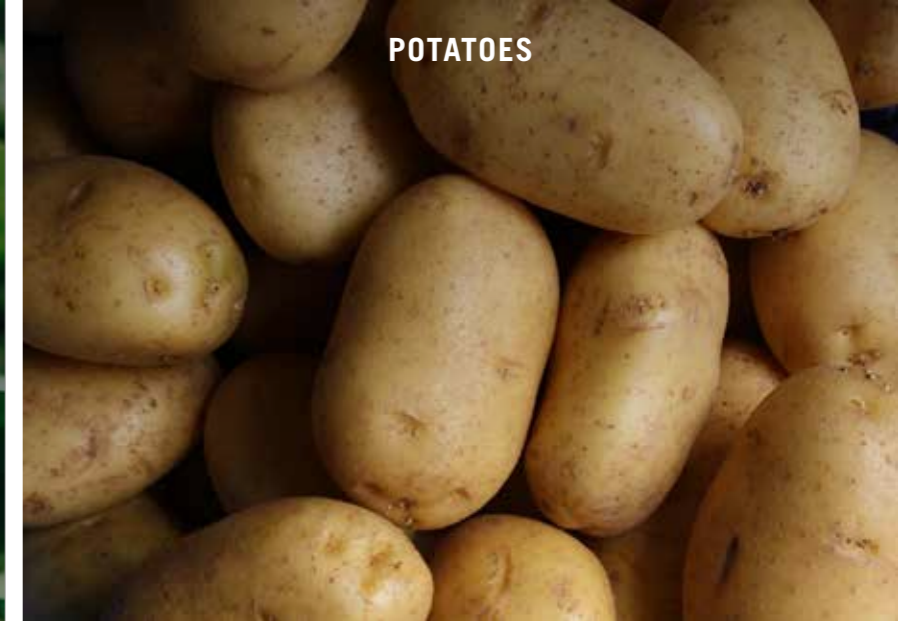



PRESERVATION MODE



MULTI.Day

Cook and preserve
for up to 72 hours

Take full advantage of **Service Temperature Food Preserving** technology. With MULTI.Day mode you can avoid bacterial proliferation in cooked meals and preserve your dishes ready for days.



SUPERHOLDING

Hold
for up to 8 hours

Use Evereo® as a **sophisticated maintainer**. Evereo® is so precise that it maintains the same uniform temperature and humidity on every shelf with extreme accuracy.

If you are looking for more **flexibility**, you can even choose to **use different features** of Evereo® at the same time!



multi
day

MULTI.DAY MODE

You just need to **hermetically seal the food** while it is still hot using an hermetic box and the **MULTI.Day Hot Vacuum** system or a simple vacuum bag, that is **MULTI.Day Bags**.

Evereo® does not alter the organoleptic properties and natural humidity of your dishes, sometimes it even improves them.

When in MULTI.Day mode, Evereo® offers its best results in preserving food that needs to be cooked for a long time – more than 40 minutes – such as braised meet, soups, goulash and many other traditional dishes.

GENERAL PRINCIPLES

Short preparations, such as fried and grilled products, **are not suitable to be preserved** with the Evereo® MULTI.Day mode, since they would lose their typical contrast between the texture of the exterior and interior part of the food. You can preserve them for a short time, normally less than 1 hour, with the Superholding mode.

Thanks to Evereo® MULTI.Day, food preservation at service temperature takes place in a **low oxygen atmosphere**. In fact, oxygen causes oxidation reactions that can ruin the organoleptic properties of food leading to its darkening or acidification. Not all food is suitable to be preserved in MULTI.Day mode.

NUTRITIONAL ASPECTS

- 01.** Preserving food with the Evereo® MULTI.Day mode **does not lead to nutrients loss due to solubilization or oxidation** since the boxes are hermetically sealed and contain little oxygen.
- 02.** Preserving food with Evereo® **fosters the protein and carbohydrate hydrolysis**, improving their digestibility.
- 03.** Preservation with Evereo® MULTI.Day **can cause the inactivation of thermolabile vitamins** such as pantothenic acid (B5) and ascorbic acid, which in any case would not be present in food after having cooked it.



MULTI.DAY HOT VACUUM

Cook your best dishes readapting them and following the advices you find in this recipe book thanks to the Unox MULTI.Day Tray. Once finished cooking, **vacuum-pack the whole tray while the food is still hot** thanks to the MULTI.Day Hot Vacuum patented technology and to the MULTI.Day Lid.

Insert the food into Evereo® to preserve it at service temperature for up to 72 hours. You will be able to **serve it in just a few seconds**, exactly when customers ask for it!

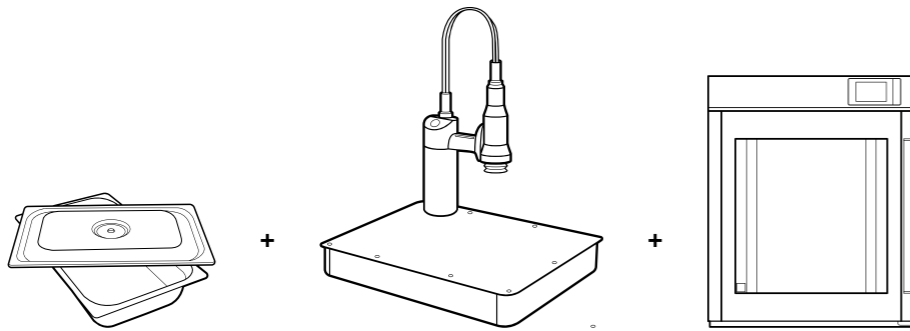

MULTI.DAY ESSENTIAL
GN 1/1 AND GN 1/2

MULTI.DAY
HOT VACUUM

EVEREO®



PROCEDURE

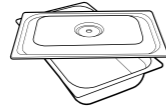

STERILISATION

Before vacuum-packing and preserving food, it is necessary to **sterilize all the tools, boxes and lids** putting them in the oven. By doing this, it is possible to avoid contamination by some microorganisms of bacterial origin that can live at temperatures above 144 °F / 62 °C causing an alteration of the food flavour and smell. A tip: sterilize the lid by leaving it in the oven while cooking the food.

Sterilization Time

45 min 248 °F / 120 °C dry
15 min 320 °F / 160 °C dry
15 min 248 °F / 120 °C steam

VACUUM TRAY PRESERVATION

Combining together the MULTI.Day Trays and the Hot Vacuum technology, it is possible to cook food in an open tray and vacuum-pack it while it is still hot once finished cooking. To guarantee the correct functioning of the Hot Vacuum system, **trays should be vacuum-packed before the temperature of the food inside them goes below 176 °F / 80 °C.**

SUGGESTIONS

1. Vacuum-pack the MULTI.Day Tray **as soon as you take it out of the oven**. Cooked food should not be touched or tasted.
2. If you didn't use a MULTI.Day Tray to cook the food, **as soon as the cooking has finished, transfer the food** into it using sterilized tools only. Food should not be touched or tasted. Once transferred, it needs to be vacuum-packed immediately.

⚠ The Hot Vacuum Pump patented technology allows you to **vacuum-pack hot food**. **Do not use normal vacuum technologies**, since hot food will produce oils and steam that would quickly and irreversibly damage the aspiration system components.

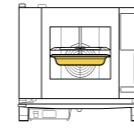

Sterilize the tray, the lid and all the tools you will use to prepare the food in the oven



Cook your best dishes readapting them, following the advices you find in this recipe book

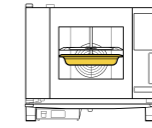

Sterilize the tray, the lid and all the tools you will use to prepare the food in the oven

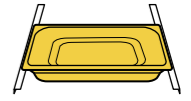

Use the MULTI.Day Tray to cook your dishes in the oven while you sterilize the lid and the other tools



When the food is ready, **put it in the vacuum MULTI.Day Trays**

remember to use only sterilized tools to handle food

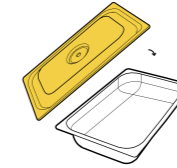

Close the trays with the specifically designed lids that will keep the pressure operated by the oxygen extraction

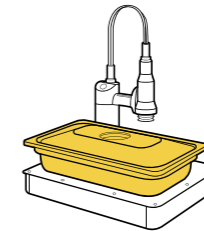

Thanks to the MULTI.Day Hot Vacuum system, **vacuum-pack** the MULTI.Day Tray while the food is still hot

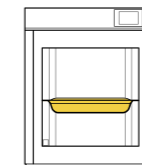

Preserve your food inside Evereo® choosing the MULTI.Day mode so as to keep it warm for up to **72*** hours

(* Preservation time can change according to the food and can also be much less than 72 hours)

MULTI.DAY BAGS

MULTI.Day Bags are designed to **withstand temperature stress** during the cooking and preservation process, ensuring that no plastic particles will migrate into the food during the preservation at service temperature period.

Once you have cooked the food inside the MULTI.Day Bags using the standard sous-vide cooking techniques, put the bags into Evereo® without cooling them down so as to preserve them for up to 72 hours at service temperature and always be ready for every order.

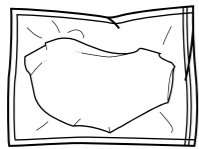

MULTI.DAY BAGS

+

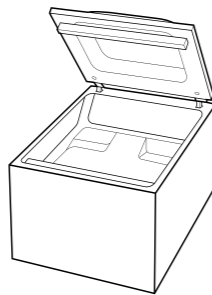

VACUUM MACHINE

+

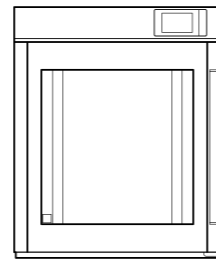

EVEREO®

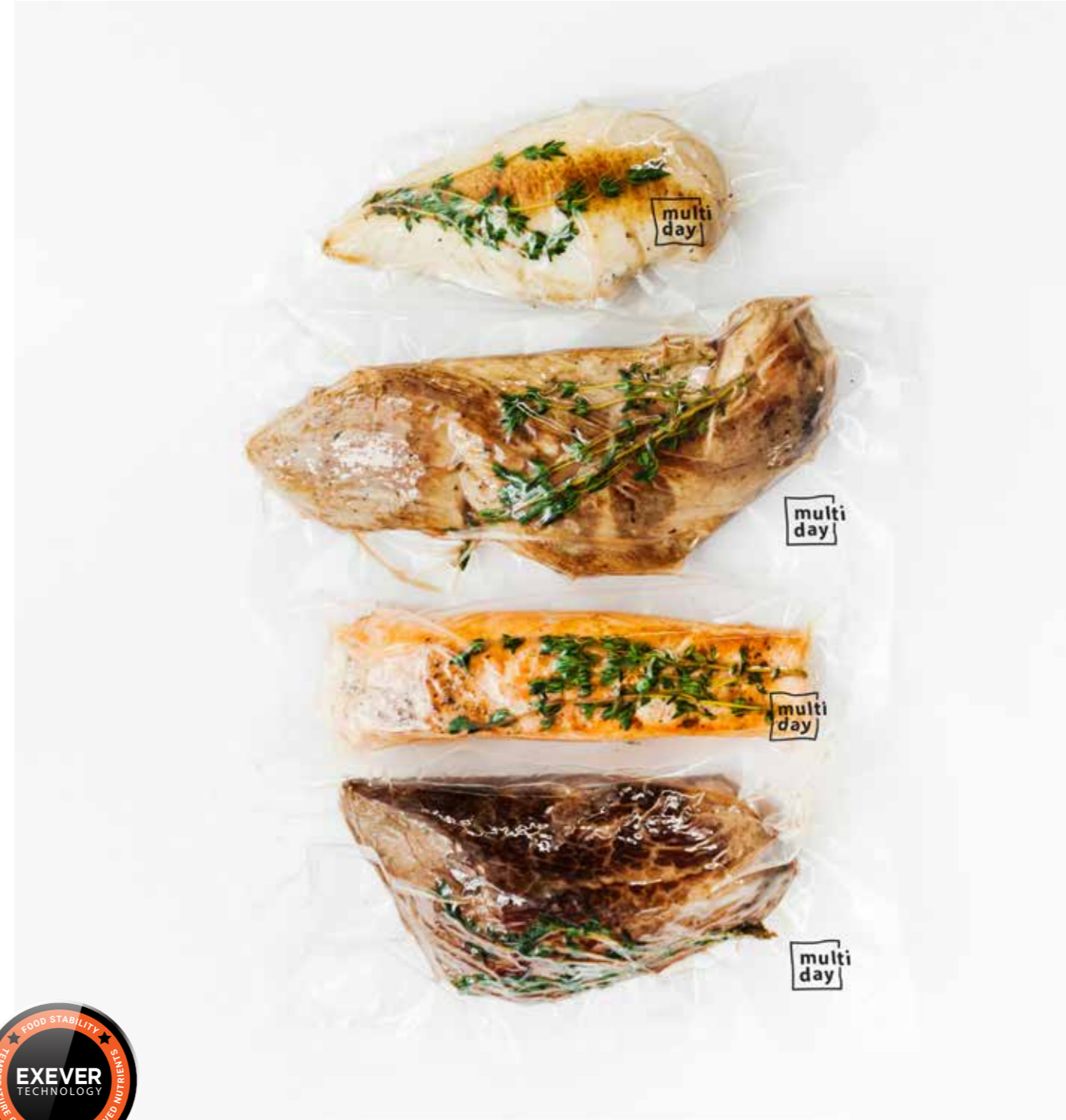

PROCEDURE

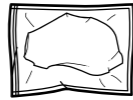

PACKING, COOKING AND VACUUM PRESERVATION

Cook your food directly in the vacuum MULTI.Day Bags, the only ones certified for the food preservation at service temperature in Evereo®.

Vacuum MULTI.Day Bags can be used to cook food up to 212 °F / 100 °C and 4 hours maximum and to preserve it in Evereo® for **maximum 72 hours at a temperature raging between 140 and 158 °F / 60 and 70 °C.**

You can buy the MULTI.Day Bags in two different sizes:

0-13/36" x 1-3/16"
1-3/16" x 1-5/8"



Insert raw food in the MULTI.Day Bags: the only ones to be certified for food preservation at service temperature

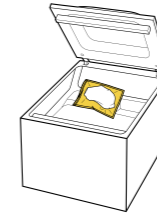

Use a traditional vacuum-packing machine to **extract the oxygen and seal the food** in the MULTI.Day Bags

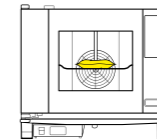

Cook the food in the MULTI.Day Bags in the oven testing your traditional recipes

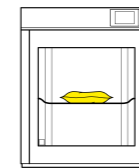

Preserve your food inside Evereo® choosing the MULTI.Day mode to keep it warm for up to **72*** hours

(* Preservation time can change according to the food and can also be much less than 72 hours)

PROCEDURE

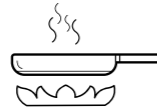

COOKING, PACKING AND VACUUM PRESERVATION

It is possible to **cook food, blast chill it and pack it in vacuum bags before putting it into Evereo®** to be preserved in MULTI.Day mode.

If you need to handle food with some tools (spoons, ladles, etc.) once finished cooking, you will need to sterilize also the tools to avoid contamination. It is fundamental to use disposable gloves while handling food.



Cook your best dishes readapting them, following the advices you find in this recipe book



Once the food has cooled down (39 °F / 4 °C), insert it in the vacuum **MULTI.Day Bags**, the only ones that are certified for the preservation at service temperature

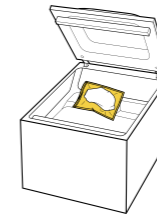

Use a traditional vacuum-packing machine to **extract the oxygen and seal the food** in the MULTI.Day Bags

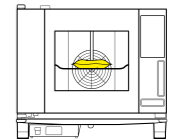

Retherm portions of food directly **in the oven**

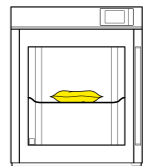

Preserve your food inside Evereo® choosing the MULTI.Day mode to keep it warm for up to **72*** hours

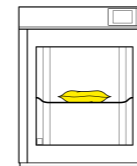

Retherm and preserve your food inside Evereo® choosing the MULTI.Day mode to keep it warm for up to **72*** hours

(* Preservation time can change according to the food and can also be much less than 72 hours)



SUPERHOLDING MODE

Evereo® allows you to **keep warm the trays with cooked food**, without being sealed, for more than the 2 hours guaranteed by traditional holding cabinets.

Thanks to its precise temperature and atmosphere control, Evereo® allows you to preserve food for **up to 8 hours** with impeccable results. You just need to set the most suitable temperature and humidity level for your food; Evereo® will do all the rest.

Your customers will notice the difference!



PROCEDURE

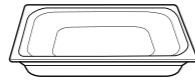

PRESERVATION IN AN OPEN TRAY

Food preservation at service temperature with the Evereo® Superholding mode takes place in a **controlled environment** as for **temperature, humidity and oxygen** level.

Superholding mode preservation time varies from 1 hour - for fast cooking products, such as fried or grilled ones - up to 8 hours - for slow cooking products, such as braised meet, soups, etc.

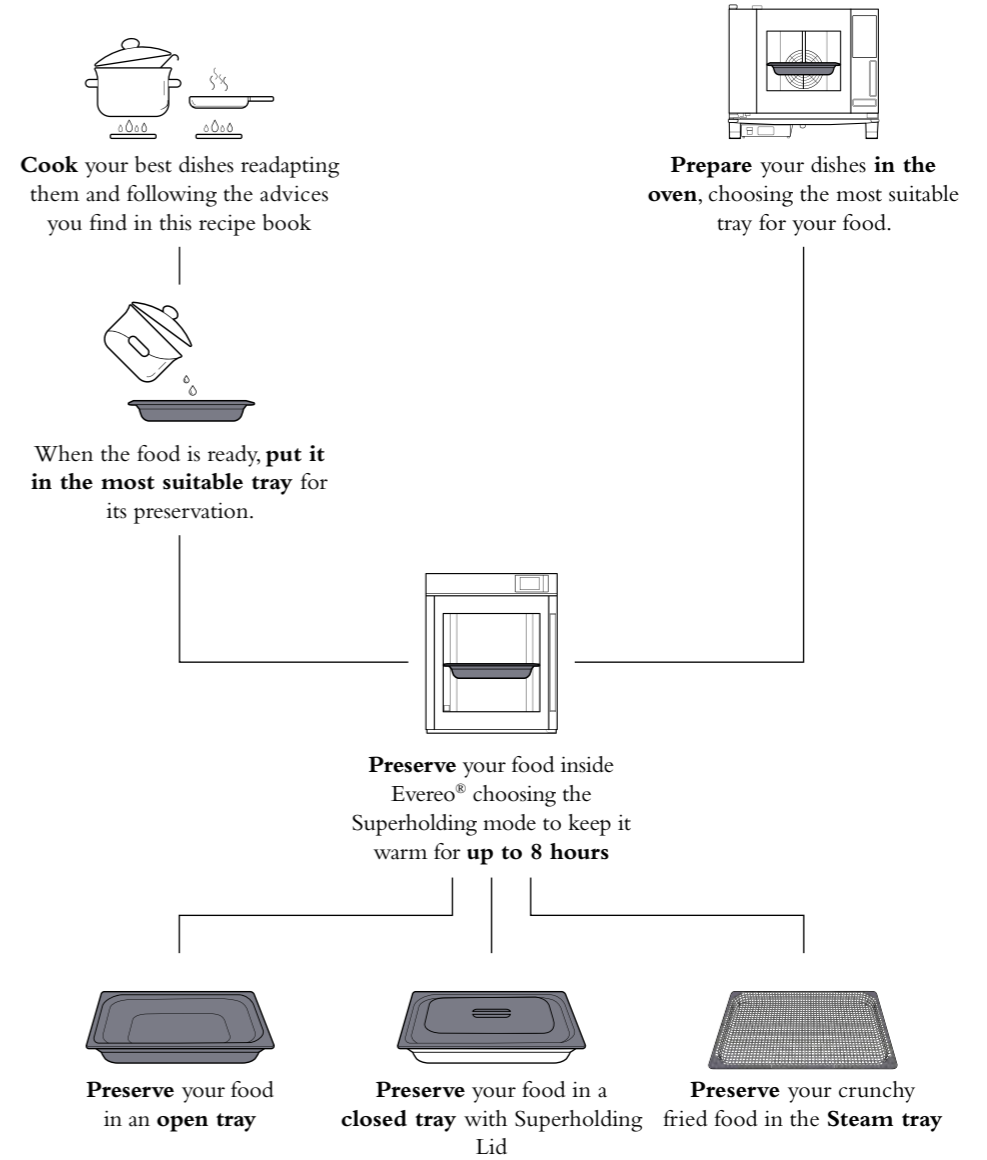

MULTI-DAY: PREPARATIONS AND RECIPES

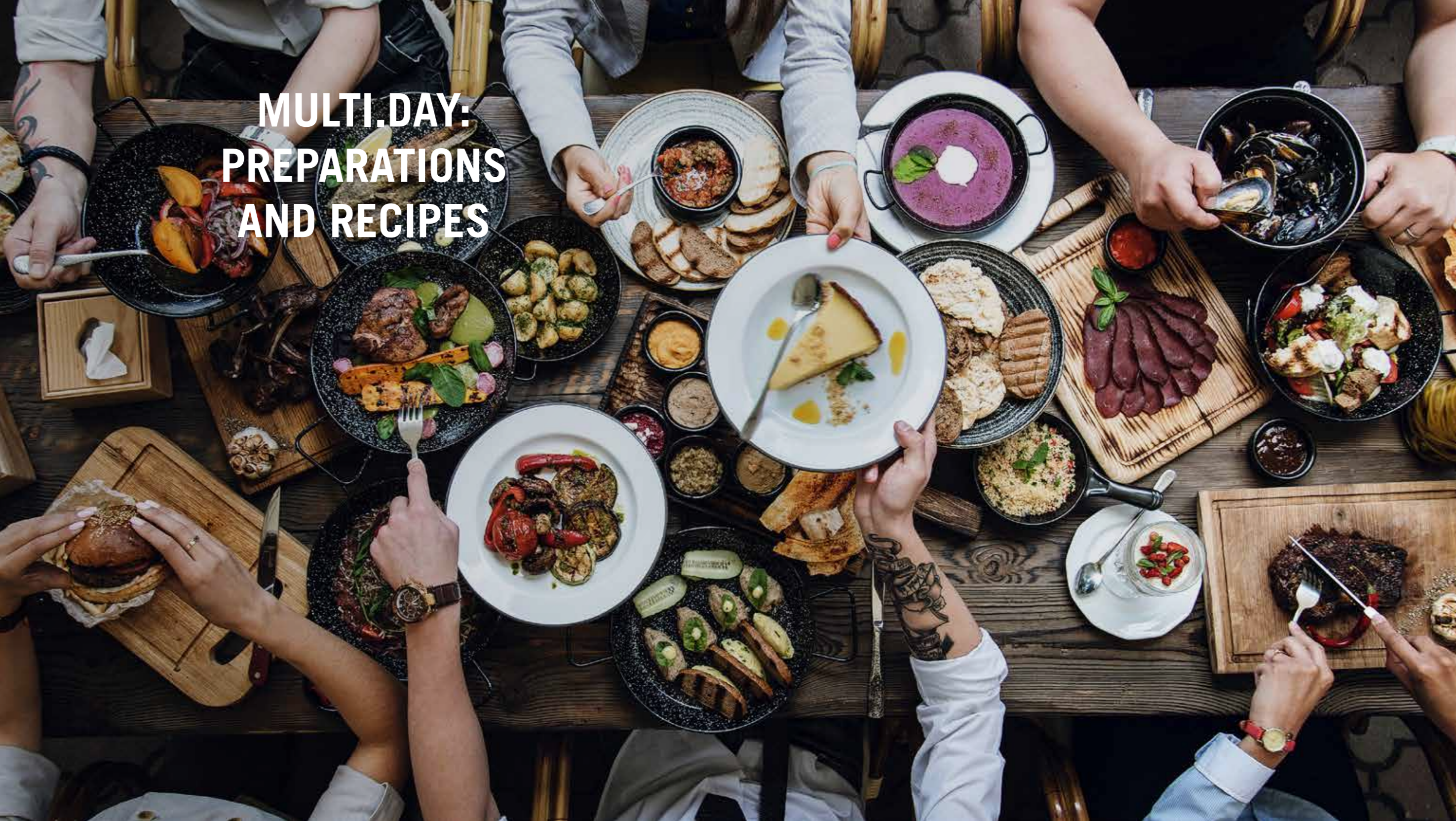



MULTI.DAY RECIPE BOOK

RECIPES CATEGORY



RED MEAT

Braised beef cheek,
Beef meatballs in tomato sauce,
Beef tongue,
Pork Cotechino,
Sous-vide spiced pork ribs



VEGETABLES

Aubergine casserole,
Braised onions,
Oven-cooked Spring onions
Aubergines with tomato sauce



WHITE MEAT

Oven roasted pork calves,
Roasted veal belly,
Pulled pork



CHICKEN

Curry chicken,
Grilled chicken breast,
Chicken thighs in tomato sauce



SAUCES

Bolognese Sauce,
Amatriciana Sauce



PASTA

Bolognese Lasagne,
Bolognese Cannelloni



RICE & CEREALS

Steamed rice & cereals,
Stewed beans with tomato and
bacon



FISH

Cuttlefish in tomato sauce



RED MEAT

The most suitable red meats to be preserved at service temperature are those whose core temperature at the end of the cooking is 144 °F / 62 °C or higher.

Red meat cuts rich in connective tissues or fat that undergo long and slow cooking processes are among the most suitable to be preserved at a service temperature in Evereo®.

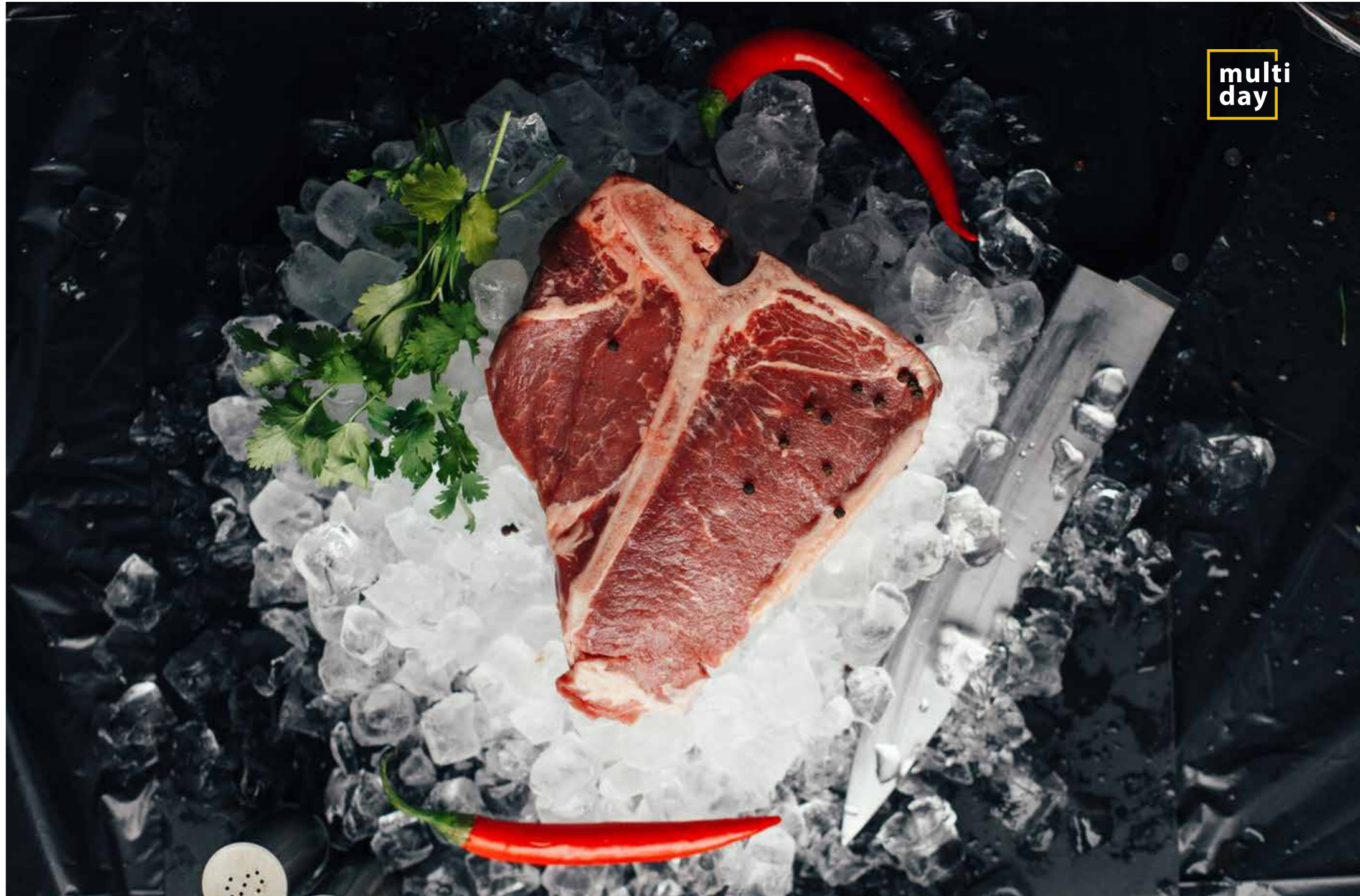

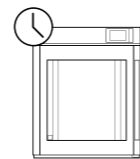

72 hours

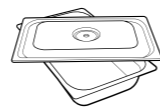

MULTI.Day Tray

Red Meat



BRAISED BEEF CHEEK

INGREDIENTS FOR 25 PORTIONS

ingredients for the meat

13,2lbs beef cheek
2 red onions
8 juniper berries
4 cloves
salt, pepper, EVO oil

ingredients for the sauce

8 cups tomato sauce
1 cup carrots
1 cup onion
2/3 cup celery
1 garlic clove
3 cup Cabernet Franc red wine
salt, pepper, EVO oil

HOW TO PREPARE THE MEAT

To obtain a perfect final result, we suggest marinating the beef with the red onions cut into small slices, juniper, cloves, salt, extra virgin olive oil and pepper for 2 to 3 hours.

Once ready, prepare the meat, trim all the excess fat and dividing it into portions.

Once finished, season again with salt, pepper and extra virgin olive oil and roast it on high heat in a non-stick pan. Otherwise, you can roast it in the oven for 12/14 minutes at 428 °F / 220 °C.

HOW TO PREPARE THE SAUCE

Put some extra virgin olive oil in a pan and put it on a medium heat.

Add celery, carrots, onions and garlic and brown them.

Once the vegetables have a nice golden colour, simmer with wine on a high heat (or you can use a kitchen torch) so as to be sure that the alcoholic part evaporates very quickly.

Pour the tomato sauce into the pan and let it cook for a couple of hours.

Once finished, it is possible to blend the mixture to obtain a smooth sauce without vegetable pieces in it. Season with salt and pepper.

PREPARATION AND COOKING

Take a MULTI.Day tray and sterilize it, then put the roasted meat in it.

Add the sauce (how much sauce is on you), cover with a sterilized lid and use the MULTI.Day Hot Vacuum to vacuum seal it.

Cook in the oven at 172 °F / 78 °C for 8 hours (or overnight you can).

PRESERVATION

Once finished cooking, take the hot tray and put it into Evereo® to preserve your braised meet at 144 °F / 62 °C for 72 hours maximum.



Red meat

BEEF MEATBALLS IN TOMATO SAUCE

INGREDIENTS FOR 15 PORTIONS

ingredients for the meatballs

- 6,6lbs minced beef meat
- 1,1lbs breadcrumbs
- 7 eggs
- salt, pepper and EVO oil

ingredients for the sauce

- 8 cups tomato sauce
- 1 cup carrots
- 1 cup onion
- 2/3 cup celery
- 1 garlic clove
- 2 basil leaves
- salt, pepper and EVO oil

HOW TO PREPARE THE MEAT

Put the minced meat in a bowl and season with oil and pepper.

Add the eggs and mix well.

Add the breadcrumbs and continue mixing.

Once the mixture is smooth, create some balls. You can decide how big you want them.

Place the meatballs into a non-stick tray, spacing them so that the air can uniformly pass through them while cooking.

Cook for 15 minutes at 374 °F / 190 °C.

HOW TO PREPARE THE SAUCE

Put some extra virgin olive oil in a pan and put it on a medium heat.

Add celery, carrots, onions and garlic and brown them.

Once the vegetables have a nice golden colour, pour the tomato sauce into the pan and let it cook for a couple of hours.

Once finished, add the basil leaves and blend the mixture to obtain a smooth sauce without vegetable pieces in it. Season with salt and pepper.

Add the cooked meatballs to the sauce and cook for 15/20 minutes on a medium heat.

Transfer the meatballs and the sauce into sterilized MULTI.Day trays and cover them with their sterilized lids.

PRESERVATION

Use the MULTI.Day Hot Vacuum to vacuum seal them and preserve in Evereo® at 144 °F / 62 °C for up to 72 hours.

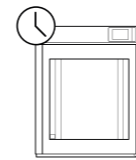

72 hours

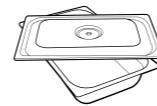

MULTI.Day Tray





multi
day

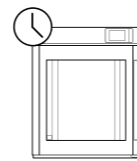

24 hours

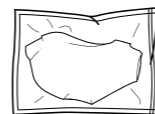

MULTI.Day Bags

Red meat



BEEF TONGUE

INGREDIENTS FOR 6 PORTIONS

2lbs beef tongue
6,7oz beef broth
3 juniper berries
1 clove
fine salt
pepper

PREPARATION

Beef tongue is a dish that is traditionally prepared using two methods: boiled or cured (pickled). In this recipe, we propose an alternative cooking method, vacuum cooked, to obtain an excellent boiled tongue without using pots that are difficult to handle and ensuring delicate and stable temperatures, thus obtaining a tongue that is cooked to perfection, tender and never too dry. We can add the enormous advantage of being able to cook it during the night, without the supervision of a cook, in this way optimising the preparation time and reducing labour costs.

Take a fresh beef tongue and wash it in plenty of running water.

With the help of a small brush, rub the entire surface, taking care to eliminate any impurities.

Place the washed tongue in a MULTI.Day Bag for cooking and heated food preservation, add all the ingredients (including the cold broth) and seal with a vacuum chamber machine, making sure that the liquids are not aspirated. If you don't have beef broth, you can put into the cooking bag the classic vegetables that are used for broth (carrots, celery, onion, parsley, etc.) and 150ml of water.

The advantage of using ready-made broth is that it increases the concentration of the taste of the tongue.

Cook for 8 hours at 78° C 100% steam.

PRESERVATION

Preserve in Evereo® at the temperature of 62 °C.

It is possible to preserve the cooked and ready to be served tongue for 24 hours maximum after cooking.



Red meat

PORK COTECHINO

INGREDIENTS FOR 16 PERSONS (2 SLICES / PERSON)

- 4 cotechini (diameter 4 cm, length 18 cm)
- light vegetable broth (water, celery, carrot, onion)

PREPARATION

Place the cotechini on the STEAM cooking pans, leaving a couple of centimetres between them to allow for the circulation of the air. If the oven does not have a fat collection system, place a large tray at the bottom of the cooking chamber.

Cook for 5 hours at 85 °C, 100% humidity and fan at 3.

When cooked, gently move the cotechini onto a MULTI.Day tray and cover them with the broth.

PRESERVATION

Preserve in Evereo® at the temperature of 62 °C. It is possible to preserve the cooked and ready to be served cotechino for up to 72 hours after cooking.

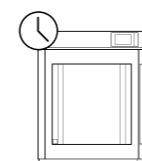

72 hours

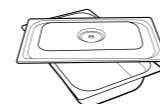

MULTI.Day Trays





multi
day

**INGREDIENTS
FOR 8 PORTIONS**

- 2 racks of pork ribs
- 3 tbs fine salt
- 1/4 tbs black pepper
- 1 tbs strong paprika
- 1 tbs powdered garlic
- 2 tbs mild paprika
- 1 tbs curry
- 1 tbs cane sugar

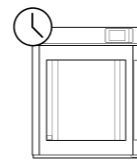

48 hours

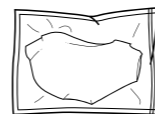

MULTI.Day Bags

Red meat



SOUS-VIDE SPICED PORK RIBS

PREPARATION

With a sharp knife parry the ribs, trying to remove the excess fat and carefully remove the membrane (periosteum) that covers the bones to make the final result even better. This membrane, in fact, dries easily during cooking, causing the taste experience to be less than excellent.

Create a classic dry rub by mixing all the dry ingredients and massage the mixture on the ribs, taking care to sprinkle it evenly and to cover every centimetre of the surface.

Once the marinade is complete, portion the ribs in the MULTI. Day Bags and vacuum seal them.

Cook for 2 hours and 30 minutes at 80 °C with 100% and fan at 4.

PRESERVATION

Preserve in Evereo® for a maximum of 48 hours at 62 °C.



VEGETABLES

All vegetables, with the exception of spinach, can be preserved. In case of preservations longer than 8 hours, for which you need to use the MULTI.Day Tray or MULTI.Day Bag, potatoes cannot be preserved, since they naturally produce oxygen and it would be therefore impossible to keep the vacuum inside the tray or bag.





Vegetables

AUBERGINE CASSEROLE

INGREDIENTS FOR 12 PORTIONS

- 6 round aubergine
- sunflower seed oil - to fry
- 8 cups tomato sauce
- 1 cup carrots
- 0,4lbs onion
- 0,3lbs celery
- 1 garlic clove
- 2 basil leaves
- salt, pepper and EVO oil
- 3 cups grated Parmesan cheese
- 4 cups mozzarella

HOW TO PREPARE

Wash and clean the aubergines before cutting them into regular slices about 1.5 cm thick.

Place the aubergines on a strainer and season with salt. Salt will cause the water inside the aubergines to leak out, thus guaranteeing a better frying result.

Place them in the fridge for a couple of hours.

Put some extra virgin olive oil in a pan and put it on a medium heat. Add celery, carrots, onions and garlic and brown them.

Once the vegetables have a nice golden colour, pour the tomato sauce into the pan and let it cook for a couple of hours.

Once finished, add the basil leaves and blend the mixture to obtain a smooth sauce without vegetable pieces in it.

Season with salt and pepper.

Take the aubergines from the fridge and flour them, it is better to use double-milled semola.

While you flour the aubergine slices, start to fry them in hot peanut oil, trying to remove the excess flour before frying so as to preserve the oil.

For the frying temperature, please refer to the smoke point of the oil as per its label.

After frying, dry each aubergine slice by means of paper towel.

Take a sterilized MULTI.Day tray and make some layers of aubergines, tomato sauce, mozzarella and grated Parmesan cheese. Repeat the layers to taste till you reach the desired thickness.

Cook it in the oven for 25 minutes at 338 °F / 170 °C with 50% humidity extraction.

PRESERVATION

Once finished cooking, close the MULTI.Day tray with its sterilized lid and use the MULTI.Day Hot Vacuum to vacuum seal it. Preserve in Evereo® at 144 °F / 62 °C for up to 72 hours.

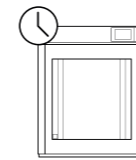

72 hours

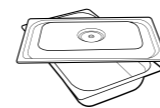

MULTI.Day Trays

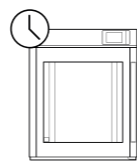

48 hours

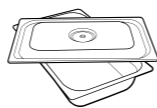

MULTI.Day Trays

Vegetables



BRAISED ONIONS

INGREDIENTS FOR 15 PORTIONS

10/15 white onions
1/3 cup cane sugar
1 cup sunflower oil
salt, pepper

PREPARATION

Peel the onions, taking care to remove each layer of skin and any shoots.

Slice them into 0.5cm thick rings to season with salt, pepper, cane sugar and sunflower oil.

Once seasoned, place the onions in a sufficiently large roast pan and roast for 18 minutes at 130 °C, 50% steam and fan at 4 and then continue for another 10 minutes at 145 °C, 50% moisture extraction and fan at 4.

PRESERVATION

Preserve in Evereo® for 48 hours maximum at 62 °C.



Vegetables

OVEN-COOKED SPRING ONIONS

INGREDIENTS FOR 10 PORTIONS

30/35 spring onions
1 1/2 cup of red wine vinegar
1 1/2 cup of red wine
8oz cane sugar
1,3gal cold water

PREPARATION

In a sufficiently large tub, dilute the wine and vinegar in 5 litres of cold water and add the cane sugar. Put the washed onions into the tray and leave to marinate overnight.

The following day, drain the onions and keep 300ml of the marinade, which will be used to bathe the onions during cooking.

Place the drained onions in a tray, taking care not to exceed in quantity to ensure that all the onions have the same exposure to the heat.

Cook for 25 minutes at 100 °C with 20% steam and fan at 3.

At the end of cooking, separate the onions from the marinade and reduce the sauce in a saucepan over high heat.

PRESERVATION

Once it has reached the desired density, add it to the spring onions and vacuum seal in a sterilised MULTI.Day Tray and preserve in Evereo® for up to 48 hours at 62 °C.

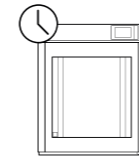

48 hours

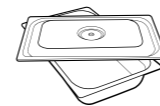

MULTI.Day Trays





multi
day

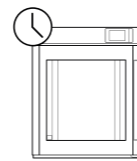

48 hours

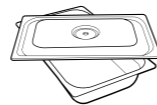

MULTI.Day Trays

Vegetables



AUBERGINES WITH TOMATO SAUCE

INGREDIENTS FOR 3 MULTI.Day Trays/ 18 PORTIONS

20 purple aubergines
8 onions
5 cloves of garlic
marjoram
thyme
basil
10 vine tomatoes
2/3 cup tomato purée
red wine vinegar
white wine
salt
pepper
extra virgin olive oil

PREPARATION

Clean the aubergines, the onions and the vine tomatoes, keeping them separate.

Cut the aubergines into 2 cm cubes, while the onions and tomatoes should be diced into cubes of about 1 cm, making sure to always keep the three ingredients separate.

Take the herbs and peeled garlic, without the core, and proceed with a very fine mince.

In a tub, season the aubergines with oil, salt and pepper and divide them into several pans. It is important not to exceed the amount of aubergines per pan to avoid the “boiled” effect. A few cubes on each cooking pan will ensure more homogeneous, faster roasting and above all, guarantee the unmistakable sautéed effect. It is important to use a good amount of extra virgin olive oil, without overdoing it, but in abundance.

Repeat the same process for the tomatoes and onions. The three ingredients have different cooking times but the same cooking temperature. It is recommended to sprinkle the onions with a drizzle of red wine vinegar to ensure better aromas and textures over time.

Once this process is complete, in a Black40 non-stick pan, mix the tomato and onion with the aubergines.

Season with pepper and salt and add the chopped herbs and a few tablespoons of tomato purée.

Mix everything and cook in the oven for 12 minutes at 200 °C with 100% humidity and the fan power at 4.

PRESERVATION

Preserve in the MULTI.Day tray for a maximum of 48 hours at 62 °C in Evereo®.



WHITE MEAT

White meat can be preserved at service temperature without any problem, since this kind of meat is typically never served rare.

In any case, after 48 hours it starts losing the perfect texture since it is normally divided into small cuts with low fat.



multi
day



White Meat

OVEN ROASTED PORK CALVES

INGREDIENTS FOR 12 PORTIONS

12 pork calves
25oz vegetable broth
17oz white wine
2 cups carrots
2 cups onion
2 cups celery
salt, pepper and EVO oil

HOW TO PREPARE

Marinate the pork calves into a mixture of 5 parts of water and 1 part of white wine.

Season with unpeeled garlic cloves, sage and rosemary and let them rest for a couple of hours.

Put the calves on a grid, season with salt, pepper and extra virgin olive oil and roast them in a hot oven for at least 10/15 minutes at 374 °F / 190 °C.

Place a fat collecting tray under the grid, so that you will be able to collect the fat and liquids released during the roasting.

While the calves are cooking, chop the celery, the carrots and the onions and brown them in a non-stick frying-pan. Add some vegetable broth to thin out the vegetable base.

Once finished cooking, use a blast chiller to cool it down to 39 °F / 4 °C.

Once the calves have a nice brown colour, blast chill them to 39 °F / 4 °C too.

Once the sauce and the meet will be cold, put them in the cooking and preserving MULTI.Day Bags (keep the sauce separated from the meat) and vacuum seal them.

Put them in the oven at 172 °F / 78 °C with 50% steam and cook for 5 hours.

PRESERVATION

Once finished cooking, transfer them into Evere® and preserve at 144 °F / 62 °C for up to 72 hours. Before serving, roast the calf and thicken the sauce.

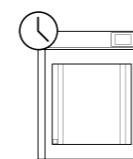

72 hours

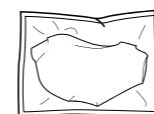

MULTI.Day Bags



multi
day

INGREDIENTS FOR 20 PORTIONS

- 1 veal belly
- ½ celery stick
- 5 carrots
- 3 onions
- 2/3 cup of still white wine
- 2 tbs mild mustard
- 2 tbs Worcestershire sauce
- rosemary
- salt, pepper

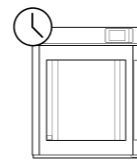

24/48 hours

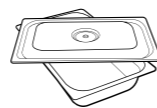

MULTI.Day Trays

White meat



ROASTED VEAL BELLY

PREPARATION

Clean the celery, carrots and onions and cut them “alla matignon” (large cubes).

Season the veal belly with salt, pepper, rosemary, mustard and Worcestershire sauce and close the meat into a roll, then tying it closed with kitchen string.

Place the seasoned vegetables with salt, pepper and oil in a large pan and place the tied veal belly on top of the vegetables.

Once cooking starts, insert the temperature probe at the heart of the roast to allow the oven to cook the roast to perfection.

Cook for 18 minutes at 190 °C 100% dry, fan at 4, and then bring the internal cooking of the roast to 72 °C with oven temperature at 90 °C and 30% humidity with fan at 2.

At the end of this cooking, the meat will be cooked but not completely tender.

PRESERVATION

The perfect consistency will be reached after 24/48 hours of storage in Evere® at 62 °C.



White meat

PULLED PORK

INGREDIENTS FOR 20 PORTIONS

- 1 pork shoulder
salt, pepper
- 3 tbs mild mustard
- 1 tbs mild paprika
- 1 tbs strong paprika
- 1 tbs powdered garlic
cane sugar
- 1 tbs curry (optional)

PREPARATION

Bone the pork shoulder or start directly from a boneless shoulder and fasten it with kitchen string to ensure a regular shape without leaving thinner cuts that could inevitably dry out.

Season the pork shoulder with the spice mix using the various ingredients and then follow by adding salt.

Let it rest in the refrigerator for 4 hours.

At the end of the marinading, roast the pork shoulder for 12 hours at 78 °C with 30% humidity and pulsed fan at 2.

After cooking, transfer the pork shoulder to a sterilised MULTI. Day Tray and vacuum seal it.

PRESERVATION

Preserve in Evereo® for up to 48 hours at 62 °C.

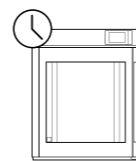

48 hours

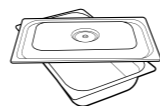

MULTI.Day Trays





POLLO

multi
day





multi
day

INGREDIENTS FOR 18 PORTIONS

- 5,5lbs chicken breast
- 5,5lbs boned chicken thigh
- 1,1lbs onion
- 1 cup red or yellow curry paste
- 2 cups butter
- 4 cups coconut cream
- 3 cups cream
- salt, pepper and EVO oil

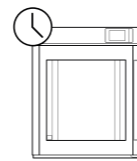

30 hours

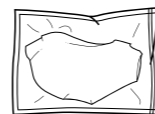

MULTI.Day Bags

Chicken



CURRY CHICKEN

HOW TO PREPARE

Cut the chicken into about 0-13/16" x 0-13/16" cubes, season with salt, pepper and half of the curry paste. Mix well and let it rest in the fridge.

Chop the onion and brown it with butter and the other half of the curry paste on a medium heat.

Once the onion is browned, add the marinated chicken and roast well.

Add the coconut cream and the cream.

Add cumin seeds and coriander to taste.

Cook for about 20 minutes on a medium heat and continue mixing. You can add some vegetable broth if necessary.

Once finished cooking, blast chill at 39 °F / 4 °C.

PRESERVATION

Divide it into portions, put it into the cooking and preserving MULTI.Day Bags and vacuum seal.

Transfer them into Evereo® and preserve at 144 °F / 62 °C for 30 hours maximum.

Before serving, follow the pasteurization times suggested by Evereo® and thicken the sauce in a pan if necessary.



Chicken

GRILLED CHICKEN BREAST

INGREDIENTS

grilled chicken breast
salt, pepper, EVO oil

HOW TO PREPARE

It is possible to preserve grilled meats as, for example, chicken breasts.

Take a chicken breast and cut it into two halves.

Season with salt, pepper and extra virgin olive oil to taste.

Grill it for just 1 minute, so that the grill signs will be visible on it. Then blast chill it rapidly.

Once cold, put it into the cooking and preserving MULTI.Day Bags and vacuum seal.

Cook the chicken in the oven for 20 minutes at 167 °F / 75 °C with 100% steam.

PRESERVATION

Once finished cooking, transfer it into Evereo® and preserve at 144 °F / 62 °C for up to 30 hours.

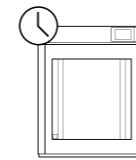

30 hours



MULTI.Day Bags



INGREDIENTS FOR 20 PORTIONS

20 chicken thighs
34oz tomato purée
salt, pepper, extra virgin olive oil
rosemary
sage
bay leaves

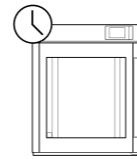

24 hours



MULTI.Day Bags

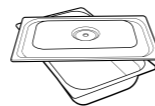

MULTI.Day Trays

Chicken



CHICKEN THIGHS IN TOMATO SAUCE

PREPARATION

Bone all the chicken thighs, eliminating the skin and any excess fat, roll each one, keeping the subcutaneous part on the outside to ensure a more homogeneous shape and a better appearance at the end of cooking.

Place them in a MULTI.Day Bag and cook them for 20 minutes at 100 °C with fan at 4.

During the pre-cooking of the chicken, bring the tomato purée with herbs (which will then be removed) to a boil in a saucepan.

At the end of the pre-cooking of the thighs, open the MULTI. Day Bag and transfer the cooking liquids into the tomato sauce.

Once the thighs are separated from the cooking liquid, transfer them to a cooking tray so that they continue browning in the oven: 5 minutes at 225 °C with 100% moisture extraction.

Continue to reduce the sauce until you get two-thirds of the initial amount.

Transfer the browned thighs to a cooking tray, cover them with the tomato sauce and finish the cooking for 10 minutes at 175 °C with 100% extraction with fan at 4.

PRESERVATION

After cooking, transfer the chicken thighs to a sterilised MULTI. Day Tray and vacuum seal it.

Preserve in Evereo® for a maximum of 24 hours at 62 °C.

multi
day



SAUCES

Sauces are the best in preserving their textures and organoleptic properties.

Depending on the ingredients of the sauce, these mixtures can be preserved for up to 72 hours* (*if you use the MULTI.Day Tray or Bags mode)



INGREDIENTS FOR 100 PORTIONS

- 11lbs minced beef meat (fat cuts)
- 11lbs minced pork meat (better if you use the leg)
- 4 cups fresh bacon
- 3 cups carrots
- 3 cups onion
- 3 cups celery
- 1 bunch of aromatic herbs (rosemary, sage, thyme, bay leaves, juniper)
- 8 cups tomato sauce
- 2 cups tomato paste
- 2qts vegetablee broth
- salt, pepper and EVO oil

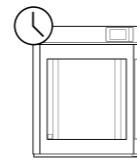

72 hours

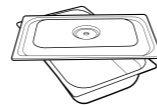

MULTI.Day Tray

Sauce



BOLOGNESE SAUCE

HOW TO PREPARE

Roughly chop the celery, the carrots and the onion and brown them in a pan on a high heat.

Add the chopped fresh bacon to the vegetables and roast it.

Add the beef and pork meat, continue to mix and make sure they are on a high heat to let the meat roast uniformly.

Add the tomato paste and the tomato sauce. Add the broth to obtain the correct texture. Add salt and pepper to taste.

Transfer the whole mixture into a big tray, add the bunch of aromatic herbs (it is highly recommended to use some gauze for food to make sure that you can take it out once finished cooking) and cook it the oven for 2/3 hours at 275 °F / 135 °C with 30% steam.

PRESERVATION

Once finished cooking, close the MULTI.Day tray with its sterilized lid and use the MULTI.Day Hot Vacuum to vacuum seal it. Preserve in Evereo® at 144 °F / 62 °C for 72 hours maximum.



Sauces

AMATRICIANA SAUCE

INGREDIENTS FOR 30 PORTIONS

- 2 onions
- 1/2gal tomato purée
- 2lbs seasoned smoked bacon
- salt

PREPARATION

Remove the rind, cut the bacon as you wish and place it on a BLACK.40 pan.

Start the cooking in the oven for 10 minutes at 175 °C, 50% extraction and fan at 4.

Finely chop the onions and add them to the bacon along with the tomato purée.

Season with salt and cook for 3 hours at 120 °C with 30% humidity and fan at 2.

At the end of cooking, separate the sauce and pour it into a MULTI.Day tray.

PRESERVATION

Preserve at 62 °C in Evereo® for up to 72 hours.

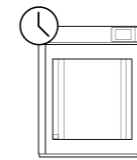

72 hours

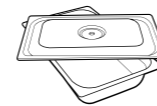

MULTI.Day Trays

multi
day



PASTA

To preserve pasta or cous cous, follow the same rules as for cereals and rice.

For example, for pasta, keep it without seasoning and separated from the sauce.

On the contrary, stuffed pasta, such as baked pasta, lasagne, pasta casserole and so on, can be preserved after cooking it without any problem as for its texture.



Pasta



BOLOGNESE LASAGNE

INGREDIENTS FOR 4 MULTI.Day Tray / 48 PORTIONS

**ingredients for the bolognese
sauce** - see page 77

ingredients for the béchamel
1,3 gal whole milk
3 1/4 cup butter
0,9lbs flour
1 pinch of nutmeg
Salt, pepper

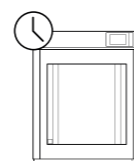

72 hours



MULTI.Day Tray

HOW TO PREPARE THE BOLOGNESE SAUCE

For the preparation of the Bolognese Sauce see page. 77

HOW TO PREPARE THE BÉCHAMEL SAUCE

Melt the butter in a casserole dish and add the flour. Cook it well to obtain a toasted roux.

Meanwhile, warm up the milk, seasoning it with salt and pepper to taste.

If you like it, you can add some grated nutmeg or nutmeg powder.

Once the milk is hot, add it to the roux a little at a time, always mixing it with a kitchen whisk or a high temperature resistant silicone spatula.

It is very important to add the milk slowly and to mix well so as to prevent lumps from forming.

Once you have added all the milk, cook on a medium heat for 15/20 minutes always mixing. Season with salt and pepper.

HOW TO PREPARE THE LASAGNE

In a sterilized MULTI.Day tray, create the lasagne with at least 5/6 layers, alternating fresh pasta, Bolognese sauce and béchamel sauce.

Once you have reached the desired thickness, finish the last layer with a lot of Bolognese sauce.

Cook in the oven at 293 °F / 145 °C for 30 minutes. Once finished cooking, close the MULTI.Day tray with its sterilized lid and use the MULTI.Day Hot Vacuum to vacuum seal it.

PRESERVATION

Preserve in Evereo® at 144 °F / 62 °C for a maximum of 72 hours.



Pasta

BOLOGNESE CANNELLONI

INGREDIENTS FOR 4 MULTI.Day TRAYS

ingredients for the pasta

- 11 1/4 cup re-milled semolina flour
- 2 1/2 cup 00 flour
- 15 egg yolks
- 15 whole eggs
- 1/2 Tsp. fine salt

ingredients for the béchamel

- see page 83

ingredients for the Bolognese

sauce - see page 77

PREPARATION OF THE BOLOGNESE SAUCE

For the preparation of the Bolognese sauce see page 77

PREPARATION OF THE BÉCHAMEL

For the preparation of the Béchamel see page 82

PREPARATION OF THE FRESH PASTA

Sift the 2 flours together twice.

On a sanitised table, arrange the flour in well, add the eggs and salt. Start incorporating the eggs into the flour with a fork and then proceed to work the dough with your hands until you have a smooth dough with no lumps.

Divide it into 500g pieces each and cover the loaves with cling film.

Let them rest for 10 minutes at room temperature and then refrigerate them for half an hour.

Once rested, roll out the dough, with the help of re-milled semolina flour and using a pasta machine.

Cut squares of about 18x18 cm and blanch them in boiling salted water for 40 seconds. Cool in water and ice immediately.

Dry the pasta and keep it divided with baking paper.

Fill the cannellone with meat sauce and béchamel and lay them on a MULTI. Day Tray with a drizzle of tomato sauce on the bottom.

Once the pan is filled, spoon in some béchamel.

Bake for 20 minutes at 170 °C with 30% humidity.

PRESERVATION

Preserve in the MULTI.Day Tray at 62 °C in Evereo® for up to 48 hours.

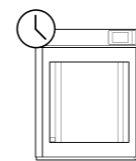

48 hours

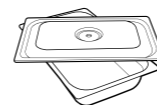

MULTI.Day Trays



multi
day



RICE & CEREALS

Rice and cereals in general, such as barley, spelt, quinoa and oats can be preserved at service temperature without the risk of overcooking them, but they need to be kept separate from the cooking liquids.

Otherwise, with the passing of time, cereals or rice would swell till they explode, losing their right texture.

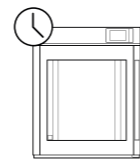

72 hours

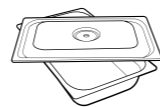

MULTI.Day Tray



STEAMED RICE & CEREALS

INGREDIENTS

rice
pearly barley
spelt

HOW TO PREPARE THE RICE

All bland cooking follow the same procedure!

Therefore it is possible to follow this procedure for all cereals such as:

Rice (Vialone, Carnaroli, Parboiled, Roma, Basmati, Jasmine, Wild, Venere)
Pearly barley
Spelt

For each part of cereals, weigh a part and a half of liquid, for example water or broth.

Place them in the oven and steam at 212 °F / 100 °C for a different time according to the food:

Rice 24 minutes
Wild rice / Venere (black) rice 35 minutes
Barley 28 minutes
Spelt 26 minutes

PRESERVATION

Once finished cooking, close the MULTI.Day tray with its sterilized lid and use the MULTI.Day Hot Vacuum to vacuum seal it. Preserve in Evereo® at 144 °F / 62 °C for 72 hours maximum.



STEWED BEANS WITH TOMATO AND BACON

INGREDIENTS FOR 3 MULTI.Day TRAYS

- 2 1/2lbs dry cannellini beans
- 0,8gal tomato sauce
- 2lbs smoky bacon
- salt
- pepper
- extra virgin olive oil
- 4 sprigs of rosemary
- 10 leaves of sage
- 1/2 cup onions

PREPARATION

Soak the beans for 12 hours.

Chop the onion and bacon and sauté in a saucepan with a drizzle of extra virgin olive oil.

Add the tomato sauce and season to taste with salt and pepper, add the herbs tied together in infusion and leave it to cook over low heat for 1 hour.

Pour the beans into GN1/1 pans and cover them with the tomato sauce.

Add just enough water, mix and cover with a sheet of baking paper.

Cook in the oven at 135 °C for 2 hours with 50% humidity and the fan at 2.

PRESERVATION

Preserve in the MULTI.Day Tray at 70 °C in Evereo® for up to 48 hours.

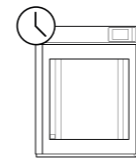

48 hours

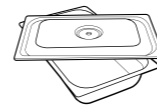

MULTI.Day Trays





FISH

By fish we mean fish, shellfish and crustaceans, and all of them can be preserved. The recipes based on fish that are best preserved at the temperature of service are sauces and stews.

Steamed, grilled and roasted fish can also be preserved, paying attention to the aroma and scents that tend to intensify after the first 24 hours.





INGREDIENTS FOR 20/25 PORTIONS

- 19lbs cuttlefish, cleaned and cut
- 0,8gal tomato purée
- 4 1/2 cups water or unsalted fish broth
- 1 bay leaf
- 1ts powdered garlic
- extra virgin olive oil
- 7/8 cups rinsed anchovies

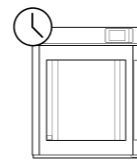

24 hours

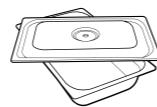

MULTI.Day Trays

Fish



CUTTLEFISH IN TOMATO SAUCE

PREPARATION

In a saucepan, pour a drizzle of oil, the bay leaf and the anchovies and sauté.

Add the cuttlefish cut any way you choose (strips or cubes) and continue to brown them.

Divide the tomato sauce into 2 large MULTI.Day Trays and add the browned cuttlefish.

Cook in the oven at 135 °C for 4 hours with 30% steam and fan at 3.

Remember to also put the lid of the pan in the oven for sterilisation.

PRESERVATION

At the end of cooking, vacuum seal and preserve in Evereo® for a maximum of 24 hours at 62 °C.

SUPERHOLDING: GUIDELINES





SUPERHOLDING

HUMIDITY 10%

TEMPERATURE

144-176°F
/ 62-80°C

8-3 H

MAINTENANCE TIME

Chosen time and temperature depend on the service process. If a food must be immediately served after leaving Evereo®, temperatures of around 158 °F / 70 °C will be needed, while if after the maintenance phase the food is sautéed in a pan or still in the oven or napped by a hot sauce, then in this case the temperatures may be lower (between 144 and 153 °F / 62 and 67 °C).

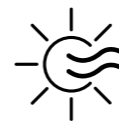

DEHYDRATED FOOD

This setting will allow you not only to preserve dehydrated food, but also to dehydrate it from scratch: you will be able to dehydrate **fruits, vegetables, meat and fish**.

Temperature varies according to how delicate the food is. Lemon or orange slices and, generally speaking, all delicate foods prefer lower temperature with respect to whole fruits or meat and fish fillets. Preservation time depends on how dry you want to keep the food.



FRIED FOOD

Recently fried food can be preserved in Evereo® for a time range between one hour and a half - for delicate fried food without breading, as for example **fried fish** - to 4 hours - for food such as **schnitzels** and **fried chicken**.

The lack of humidity will keep the crust crunchy and the temperature stability will allow you to serve excellent fried food even after some hours.

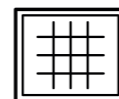

GRILLED FOOD

Grilled food can be preserved with a percentage of humidity that varies from 10% to 30%. Time is the determinant in the choice of humidity: the longer the desired holding time is, the higher humidity percentage is required. Besides this rule of thumb, there are other variables to take into account: the more a food, be it **meat, vegetable or fish**, is rich in humidity, the less external humidity will be needed to hold it. That is the reason why in this section we will see some examples of grilled food that can be held with 10% of humidity, while grilled food that can be held with 30% of humidity will be described at page 120. Any example?

Grilled vegetables are rich in water and therefore can be hot preserved with a perfect texture using only 10% of humidity for 3 hours.

When preserving meat, the temperature varies according to the internal cooking point of the meat. **Grilled rare meat** cannot be preserved for more than some minutes, since the temperatures which guarantee maximum food safety are higher than the meat core temperature and preserving it for more than 5/6 minutes would cook its interior.

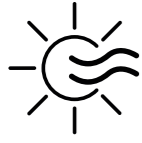

DEHYDRATED FOOD

HUMIDITY 10%

Not just an holding cabinet! Among the multiple functions of Evereo®, one of the most interesting is drying. Thanks to its precise parameters management in the holding chamber and **the low level of humidity, it is possible to use Evereo® as a real drier.** Let your imagination run freely and try all the recipes.

SUPERHOLDING SET

100 — EVEREO® Recipes



DEHYDRATED ORANGES AND LEMONS

Orange and lemon slices can be dehydrated directly in Evereo® using some baking paper or a silicon mat to prevent the food from sticking to the pan during the process. It is recommended to use low temperatures to keep the orange's and lemon's original colours as much as possible. Time varies according to the slices thickness.



DRIED MUSHROOMS

Evereo® can be transformed into a real drier. Even with mushrooms you can achieve perfect results, drying them perfectly and keeping their shapes, aromas and natural colours. **Porcini, champignons, chanterelles and honey mushrooms** will dry perfectly in reduced time (which will vary according to the food dimensions and thickness) with excellent results, without drying up too much and without altering their natural flavours.



SEMIDRIED TOMATOES

Very easy to prepare and the time needed will be halved with respect to the natural drying. Also for **tomatoes**, it is recommended to use flat trays with baking paper or a silicone mat. Space the tomatoes so as to foster the hot air passage through them, so that they will be perfectly dried.

SUPERHOLDING SET

101 — EVEREO® Recipes



FRIED FOOD

HUMIDITY 10%



154°F/
68°C | 10% | 2H

FRIED FISH

Fried fish, prepared with flour or batter, can be held without problems for an hour and a half and it will seem as if it had just been fried. Clearly, the thicker a piece is, the better and tastier it will be, soft inside and crunchy outside (**squids and shortfin squids rings or shrimps**), while less thick parts, such as the **cuttlefish tentacles, small fishes or schie** (small shrimp from the lagoon) will tend to last only 1 hour.



154°F/
68°C | 10% | 3H

BATTERED FRIED FOOD

Courgette flowers, carrots, shrimps, aubergines, cauliflowers, asparagus, broccoli, radicchio and much more. All battered products (be it with beer or sparkling water) can be held in Evereo® for 2 or 3 hours, depending on the kind of food, and served as if they had just been fried.



158°F/
70°C | 10% | 3H

BREADED FRIED FOOD

Breaded products made with breadcrumbs such as **chicken schnitzel, fish fillets, fried aubergines or courgettes**, or with panko, such as fried chicken, can be held for an incredibly long time: even 3 or 4 hours. As usual, time depends on the food thickness: the thinner it is, the less time it can be held.

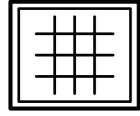

GRILLED FOOD

HUMIDITY 10%



149°F/
65°C | 10% | 3H

GRILLED MEAT

The holding time of **grilled meat** is variable and depends on many factors: rare red meat need a reduced holding time, since the recommended minimum temperature is higher than the meat core temperature and a long holding time could continue its cooking. Meats that have a core temperature higher than or equal to 144 °F / 62 °C can be held even for 3 hours with excellent results as for texture and colour. Meats that can be held with 10% of humidity are typically meats with fat coverings, such as picana, cuts of meat with intense marbling, or meats protected by rind such as pork bacon. Fat minced meat preparations such as meatloaves or sausages can be maintained with 10% of humidity.



153°F/
67°C | 10% | 3H

GRILLED FISH

What has been said about meat, is equally true for fish. It is not recommended to hold very rare **tuna steaks** for more than 30 minutes, since the cooking could continue. Whereas, large fish fillets such as **halibut** or **whole fishes**, which therefore contain high percentages of water, can be held for up to 2 hours without any particular problem. In case of **stewed fish**, the humidity coming from the sauce makes it possible to hold it for up to 3 hours.



145°F/
63°C | 10% | 3H

GRILLED VEGETABLES

Generally speaking, **grilled vegetables** can be held in Evereo® even for hours without losing their texture and flavour.

Cutting them thick and a little seasoning before holding them in Evereo® at service temperature will help grilled vegetables to resist even for a longer time without drying up and without losing their natural colour.



SUPERHOLDING

-
HUMIDITY 90%

TEMPERATURE

144-176°F
/ 62-80°C

8-3 H

MAINTENANCE TIME

Chosen time and temperature depend on the service process. If a food must be immediately served after leaving Evereo®, temperatures of around 158 °F / 70 °C will be needed, while if after the maintenance phase the food is sautéed in a pan or still in the oven or napped by a hot sauce, then in this case the temperatures may be lower (between 144 and 153 °F / 62 and 67 °C).



SOUS-VIDE FOOD

Sous-vide food is the less delicate and the less subject to climate changes since the plastic bags isolate it in its cooking liquid. Nevertheless, it is fundamental to use the right temperature not to overcome the cooking point and not to alter the colours, above all with vegetables such as broccoli.

Moreover, the temperature choice should be made on the basis of the preserved food: the preservation temperature should not be higher than the core temperature, otherwise you risk overcooking the food.



STEAMED FOOD

All steamed food can be preserved in Evereo® provided that there is enough humidity (between 80 and 90%). Lower humidity percentages risk drying out the food.

It is still to be considered that **fruit and vegetables with green leaves** need lower temperatures not to alter their colours.



BRAISED FOOD

Braised meats are the best to be preserved at service temperature since their core temperature at the end of the cooking process are higher than the temperature needed to keep them warm. This means longer preservation times that make meat even more soft and even easier to digest. **Braised meat with or without sauce** will find in Evereo® the perfect conditions to be preserved for even more than 8 hours without any negative alteration. Temperature will keep it warm and safe from the bacterial point of view and humidity will keep its exterior soft.



SOUS-VIDE FOOD

HUMIDITY 90%



153°F/
67°C | 90% | 3H

SOUS-VIDE FISH

Fish, molluscs and crustaceans that reach a temperature of 144 °F / 62 °C during the cooking process can be held in Evereo® for hours without problems. Fishes with a lot of flesh, such as sea bass, giltheads, sardines, soles or halibut offer an ideal thickness which allows to held them even for 2 or 3 hours at 153 °F / 67 °C. In case of crustaceans, such as **shrimps, prawns, lobsters and spiny lobsters**, it is recommended to use lower temperatures, for example 140/144 °F / 60/62 °C to preserve their delicate texture.



154°F/
68°C | 80% | 3H

SOUS-VIDE MEAT

Using the same meat cut, a sous-vide cooking is always more delicate than a traditional one and the **meat** will be softer, more succulent and rich in liquid, therefore it will weigh more. It is important to keep a precise temperature during the holding phase so as not to ruin the meat texture. Thanks to its sensors, Evereo® controls the temperature throughout the holding chamber and can preserve food even for days. **Meat rich in connective tissues**, perfect to be braised or stewed, will find in Evereo® the perfect conditions to be preserved and even to improve, becoming softer, tastier and even easier to digest.



149°F/
65°C | 90% | 3H

SOUS-VIDE VEGETABLES AND FRUIT

Cooked fruit and vegetables have different holding times that depend on the transformation they underwent. A fruit **compote** or a **tomato sauce** can be preserved for days without problems. **Roasted vegetables**, that have then been kept sous-vide, can be held for 2 or 3 hours. The most delicate parameter for **green fruit and vegetables** is colour: when in a sous-vide bag or in contact with heat, it is easy that the original, lively green colour will become darker, therefore it is recommended to use short holding times. **Aubergines, peppers, tomatoes and carrots** do not have any problems.



STEAMED FOOD

HUMIDITY 90%



145°F/
63°C | 90% | 2H

STEAMED VEGETABLES

What has been said about **sous-vide vegetables**, is equally true for steamed vegetables. All green food at some point starts to lose its colour. To prevent oxidation and to have a more pleasant aesthetic result, it is recommended to **season steamed or boiled vegetables** with extra virgin olive oil before preserving them. Seasoned steamed vegetables can be held for 2 hours without problems.



145°F/
63°C | 80% | 4H

STEAME RICE&CEREALS

Thanks to its precise temperature management, Evereo® can hold cooked **rice and cereals** for hours without overcooking them. **Venere (black) rice, basmati rice, parboiled rice, spelt, barley, wild rice and gluten free durum-wheat pasta** are some examples of food that can be held in the best possible way for 4 or 5 hours. It is recommended to keep food in a covered pan, so as to keep humidity coming from the food inside the tray. A tray without a lid could lead to dry too much the food surface.



149°F/
65°C | 90% | 4H

BOILED MEAT

Steamed chicken, steamed beef cuts, boiled poultry, cotechino (cooked pork sausage) **and pig's trotters** can be held in Evereo® for 3 or 4 hours without altering their organoleptic properties. As for all kinds of meat, thickness has a fundamental role: the thicker the meat is, the longer it will be possible to preserve it with a better quality. To hold steamed or boiled meat, it is recommended to keep it in broth in a big tray.



BRAISED FOOD

HUMIDITY 90%



154°F/
68°C | 90% | 6H

HOT POTS AND STEWS

Hot pots, stews and all meat cuts that are slow cooked for a long time are ideal to be held. Textures will improve, meat will not be overcooked and can be held for 8 hours without drying up or splitting apart. Stewed or braised meat and goulash can be prepared in advance and held hot in Evereo® being ready to be served without having to retherm them.



158°F/
70°C | 90% | 6H

SAUCES, PASTA SAUCES AND GRAVY

As for braised meat, **saucers, pasta saucers and gravy** can also be held in Evereo® for hours without losing their quality. Tomato saucers can be held without alterations even for a longer time thanks to the tomato anti-oxidant properties. Using the Superholding mode to hold saucers and pasta saucers means reducing the service time and making the plating and delivery process easier. Very fat saucers or saucers made with cream after two hours could separate the liquid part from the fat one. It will be sufficient to mix them from time to time to restore the original conditions.



153°F/
67°C | 90% | 4H

WHOLE CUTS OF BRAISED MEAT

Also for **whole cuts of braised meat** that will be sliced during the service, holding at service temperature is an optimal condition. The meat will remain soft, tasty and the temperature won't be too high thus it won't be an obstacle while cutting the meat. It is possible to hold the whole cut in a sous-vide bag or in an open tray and slice it into portions during the service. In case the braised meat has already been sliced, it is recommended to hold it at service temperature with its gravy to make it even softer.



SUPERHOLDING

HUMIDITY 30%

TEMPERATURE

144-176°F
/ 62-80°C

8-3 H

MAINTENANCE TIME

Chosen time and temperature depend on the service process. If a food must be immediately served after leaving Evereo®, temperatures of around 158 °F / 70 °C will be needed, while if after the maintenance phase the food is sautéed in a pan or still in the oven or napped by a hot sauce, then in this case the temperatures may be lower (between 144 and 153 °F / 62 and 67 °C).



LOW TEMPERATURE ROASTS AND TRADITIONAL ROASTS

Low temperature roasts and traditional roasts can be preserved without any particular problem. 30% of humidity will ensure that food, meat in particular, remains soft, without losing its texture and its typical “boiled meat” smell. Preservation time for roasts depends only on two factors: the first and most important one is how much humidity the food lost during the cooking process. It is not by chance that, between a traditional roast and a low temperature one, the latter will be better preserved, since it will have more liquids inside and its softness will last longer.

The choice of the temperature depends on the service process. If food is served immediately after it is taken out from Evereo®, the temperature should be around 158 °F / 70 °C, whereas if, after the preservation, you want to roast it in a pan or in the oven or you serve it with a hot sauce, then the temperature can be lower (between 144 and 153 °F / 62 and 67 °C).

It is always important to keep in mind how cooked the meat is inside. An English Roast beef, for example, will be cooked when the core temperature is 133 °F / 56 °C. If we preserve the roast beef for a couple of hours at 144 °F / 62 °C, it will lose its typical medium-rare appearance. Therefore roast beef is a kind of meat that cannot be preserved.

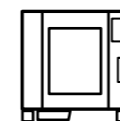

BAKED FOOD

Baked food can find in Evereo® the perfect conditions not only to be preserved as if it had just been baked, but it can also improve. We are talking about all food cooked in an oven pan or tray, such as: **lasagne, aubergine casserole, cannelloni** (stuffed rolls of dough), **baked fish, quiches, omelette and meatballs** with tomato sauce. 30% of humidity will keep food soft without making it wet and without ruining its external appearance. The precise temperature will keep perfect textures for food that can be preserved at service temperature even for 6/8 hours without any problem.

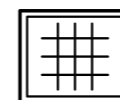

GRILLED FOOD

Grilled food can be preserved with a percentage of humidity that varies from 10% to 30%. Time is the determinant in the choice of humidity: the longer the desired holding time is, the higher humidity percentage is required. Besides this rule of thumb, there are other variables to take into account: the more a food, be it **meat, vegetable** or **fish**, is rich in humidity, the less external humidity will be needed to hold it. That is the reason why in this section we will see some examples of grilled food that can be held with 30% of humidity, while grilled food that can be held with 10% of humidity will be described at page 104. Any example?

When preserving meat, the temperature varies according to the internal cooking point of the meat. **Grilled rare meat** cannot be preserved for more than some minutes, since the temperatures which guarantee maximum food safety are higher than the meat core temperature and preserving it for more than 5/6 minutes would cook its interior.



ROAST

HUMIDITY 30%



RED MEAT

All **roasted red meats** can be held with the Superholding mode, but the rule to follow is always the same: the best food to be held is the one that reaches a minimum temperature of 144 °F / 62 °C. Roast beef, for example, cannot be held for more than 30 minutes, since the safety temperature is higher than the core temperature of the product. Whole roasts or sliced roasts at their cooking point can be perfectly held thanks to Evereo® precise temperature management.



WHITE MEAT

Besides **chicken, veal, rabbit and turkey, pork meat** also has to be included in this category, in particular those cuts which are cooked at low temperatures and roasted, such as pork legs, calves and loin. Normally, these cuts are cooked for a period of time that allows them to reach a core temperature equal to or higher than 144 °F / 62 °C, so they are compatible with the Superholding mode. Also a whole roasted chicken with soft meat and crunchy skin can be held for a long time if humidity does not exceed 30%. It is not recommended to hold roasted chicken without humidity otherwise the meat will dry too much and it will lose softness and taste.



FISH

What has been said about grilled fish, is equally true for **baked fish**. Thick fillets guarantee a longer holding time, a serving sauce gives more softness to them. In case of “natural” roasted fish, as for example baked fish or fish in a salt crust, it is recommended to keep humidity at a percentage not higher than 30% to keep the skin crunchy. With a higher level of humidity the risk is ruining its texture, whereas, with a humidity of less than 20% the fibres could become too dry, making it gristly or reducing consistently the holding time.

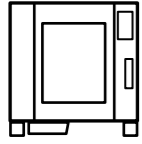

BAKED FOOD

HUMIDITY 30%

SUPERHOLDING SET

118 — EVEREO® Recipes



145°F/
63°C | 30% | 4H

STUFFED PASTA AND LASAGNE

Baked pasta, lasagne Bolognese or aubergine casserole are just some examples of the classic baked products that find in Evereo® the perfect conditions to be held hot, tasty, stringy and with a crunchy surface for hours! Pasta won't be overcooked, cheese will be at the perfect temperature: soft, but never too hot. Stuffed pasta can be held with the Superholding mode for up to 6 hours without losing its organoleptic properties and remaining perfect under every point of view.



154°F/
68°C | 30% | 3H

BAKED FISH

What has been said about grilled fish, is equally true for baked fish. Thick fillets guarantee a longer holding time, a serving sauce gives more softness to them. In case of "natural" roasted fish, as for example baked fish or fish in a salt crust, it is recommended to keep humidity at a percentage not higher than 30% to keep the skin crunchy. With a higher level of humidity the risk is ruining its texture, whereas, with a humidity of less than 20% the fibres could become too dry, making it gristly or reducing consistently the holding time.



154°F/
68°C | 30% | 2H

AU GRATIN FOOD

Tomatoes au gratin, gnocchi alla romana (Roman semolina gnocchi), mushrooms, fish in a crust, cannelloni (stuffed rolls of noodle dough), crepes: this food is not sensitive to temperature, and does not require a specific texture, so this means that it can be held for longer periods without problems. The big advantage of holding it in Evereo® is that, thanks to the humidity measuring and handling technology, food that is soft inside and crunchy outside, will maintain the right texture for longer periods of time, allowing you to serve it with the maximum quality even after many hours.

SUPERHOLDING SET

119 — EVEREO® Recipes

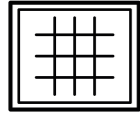

GRILLED FOOD

HUMIDITY 30%



149°F/
65°C | 30% | 3H

GRILLED MEAT

The holding time of **grilled meat** is variable and depends on many factors: rare red meat need a reduced holding time, since the recommended minimum temperature is higher than the meat core temperature and a long holding time could continue its cooking. Meats that have a core temperature higher than or equal to 144 °F / 62 °C can be held even for 3 hours with excellent results as for texture and colour. Meats that can be held with 10% of humidity are typically meats with fat coverings, such as picana, cuts of meat with intense marbling, or meats protected by rind such as pork bacon. Fat minced meat preparations such as meatloaves or sausages can be maintained with 10% of humidity.



153°F/
67°C | 30% | 3H

GRILLED FISH

What has been said about meat, is equally true for fish. It is not recommended to hold very rare tuna steaks for more than 30 minutes, since the cooking could continue. Whereas, **large fish fillets** such as **halibut** or **whole fishes**, which therefore contain high percentages of water, can be held for up to 2 hours without any particular problem. In case of **stewed fish**, the humidity coming from the sauce makes it possible to hold it for up to 3 hours.



145°F/
63°C | 30% | 3H

GRILLED VEGETABLES

Generally speaking, **grilled vegetables** can be held in Evereo® even for hours without losing their texture and flavour.

Cutting them thick and a little seasoning before holding them in Evereo® at service temperature will help grilled vegetables to resist even for a longer time without drying up and without losing their natural colour.

RECIPES SUMMARY DIVIDED BY CATEGORY

RED MEAT		
Braised beef cheek,	38	
Beef meatballs in tomato sauce,	40	
Beef tongue,	42	
Pork cotechino,	44	
Sous-vide spiced pork ribs	46	
<hr/>		
VEGETABLES		
Aubergine casserole,	50	
Braised onions,	52	
Oven-cooked spring onions,	54	
Aubergines with tomato sauce	56	
<hr/>		
WHITE MEAT		
Oven roasted pork calves,	60	
Roasted veal belly,	62	
Pulled pork	64	
<hr/>		
CHICKEN		
Curry chicken,	68	
Grilled chicken breast,	70	
Chicken thighs in tomato sauce	72	
<hr/>		
SAUCE		
Bolognese sauce,	76	
Amatriciana sauce	78	
<hr/>		
PASTA		
Bolognese Cannelloni,	82	
Bolognese Lasagne	84	
<hr/>		
RICE&CEREALS		
Steamed rice&cereals,	88	
Stewed beans with tomato and bacon	90	
<hr/>		
PESCE		
Cuttlefish in tomato sauce	94	
<hr/>		
DEHYDRATED FOOD - HUMIDITY 10%	100	
Dehydrated oranges and lemons		
Dried mushrooms		
Semidried tomatoes		
<hr/>		
FRIED FOOD - HUMIDITY 10%	102	
Fried fish		
Battered fried food		
Breaded fried food		
<hr/>		
GRILLED FOOD - HUMIDITY 10% / 30%	104/120	
Grilled meat		
Grilled fish		
Grilled vegetables		
<hr/>		
SOUS-VIDE FOOD - HUMIDITY 90%	108	
Sous-vide fish		
Sous-vide meat		
Sous-vide vegetables and fruit		
<hr/>		
STEAMED FOOD - HUMIDITY 90%	110	
Steamed vegetables		
Steamed rice&cereals		
Boiled meat		
<hr/>		
BRAISED FOOD - HUMIDITY 90%	112	
Hot pots and stew		
Sauces, pasta sauces and gravy		
Whole cuts of braised meat		
<hr/>		
ROASTED FOOD - HUMIDITY 30%	116	
Red meat		
White meat		
Fish		
<hr/>		
BAKED FOOD - HUMIDITY 30%	118	
Stuffed pasta and lasagne		
Baked fish		
Au gratin food		

RECIPES SUMMARY IN ALPHABETICAL ORDER

MULTI.DAY			SUPERHOLDING	
Amatriciana sauce	78		Au gratin food - baked food	118
Aubergine casserole	50		Baked fish - baked food	118
Aubergines with tomato sauce	56		Battered fried food - fried food	102
Beef meatballs in tomato sauce	40		Boiled meat - steamed food	110
Beef tongue	42		Breaded fried food - fried food	102
Bolognese Cannelloni	82		Dehydrated oranges and lemons - dehydrated food	100
Bolognese Lasagne	84		Dried mushrooms - dehydrated food	100
Bolognese sauce	76		Fish - roasted food	116
Braised beef cheek	38		Fried fish - fried food	102
Braised onions	52		Grilled meat - grilled food	104/120
Chicken thighs in tomato sauce	72		Grilled fish - grilled food	104/120
Curry chicken	68		Grilled vegetables - grilled food	104/120
Cuttlefish in tomato sauce	94		Hot pots and stew - braised food	112
Grilled chicken breast	70		Red meat - roasted food	116
Oven-cooked spring onions	54		Sauces, pasta sauces and gravy - braised food	112
Oven roasted pork calves	60		Semidried tomatoes - dehydrated food	100
Pork cotechino	44		Sous-vide fish - sous-vide food	108
Pulled pork	64		Sous-vide meat - sous-vide food	108
Roasted veal belly	62		Sous-vide vegetables and fruit - sous-vide food	108
Sous-vide spiced pork ribs	46		Steamed rice&cereals - steamed food	110
Steamed rice&cereals	88		Steamed vegetables - steamed food	110
Stewed beans with tomato and bacon	90		Stuffed pasta and lasagne - baked food	118
<hr/>			White meat - roasted food	116
			Whole cuts of braised meat - braised food	112



MEAL ME MODE

Do your customers want to be **served quickly** and eat quality food without having to wait?

This is exactly what Meal Me allows you to do: in the **online* Marketplace**, you will find some dishes ready to be sold, preserved in modified atmosphere and you will also be able to order them directly from your smartphone. Each producer is subject to instructions and controls by Exever, to always grant you the quality you expect.

Food will be delivered to you at 39 °F / 4 °C, then you will just need to insert it in Evereo® and keep it at service temperature in your premises, **ready to be served**, regardless of time and day, When and where you want it.

* Available in some countries only.
For more info, visit the www.mealmefood.com website



Access the food **E-commerce** on the **mealmefood.com** portal



Pick your **menù** and discover all the **available dishes** granted by Exever experts and designed to match your taste

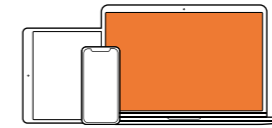

Easily **order** your favourite dishes **online**, directly from your smartphone



The dishes you ordered will be **shipped** to you in vacuum bags thanks to the cold chain

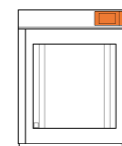

Receive your ready dishes and **preserve** them in Evereo® at the same **temperature at which you will serve them**

EVEREO

unox.com

