



HOSHIZAKI

Parts List

Steelheart Series
Refrigerated Kitchen Equipment

Models

PR46A(-D2)

PR67A(-D2)(-D4)

PR93A(-D2)(-D4)(-D6)



hoshizakiamerica.com

Number: 71423
Issued: 12-20-2018
Revised: 12-17-2020

CONTENTS

Auxiliary Codes.....	3
Note About Ordering Parts	4
A. Main Assembly	5
PR46A(-D2).....	5
PR67A(-D2)(-D4)	7
PR67A(-D2)(-D4)	8
PR93A(-D2)(-D4)(-D6)	11
PR93A(-D2)(-D4)(-D6)	12
B. Refrigeration Circuit.....	15
C. Door-Right Hinged.....	17
D. Door-Left Hinged	18
E. Drawer Assembly	19
F. Accessories & Labels.....	20

Auxiliary Codes

PR46A

H-5 November 2018
J-5 January 2019
J-6 September 2019
K-5 January 2020
K-6 March 2020
K-7 August 2020

PR46A-D2

H-5 June 2018
H-6 November 2018
J-5 January 2019
J-6 September 2019
K-5 January 2020
K-6 March 2020
K-7 July 2020

PR67A

H-5 November 2018
J-5 January 2019
J-6 September 2019
K-5 January 2020
K-6 March 2020
K-7 June 2020
K-8 October 2020

PR67A-D2

H-6 November 2018
J-5 January 2019
J-6 September 2019
K-5 January 2020
K-6 March 2020
K-8 October 2020

PR67A-D4

H-5 July 2018
H-6 November 2018
J-5 January 2019
J-6 September 2019
K-5 January 2020
K-6 March 2020
K-7 June 2020
K-8 October 2020

PR93A

H-5 November 2018
J-5 January 2019
J-6 September 2019
K-5 January 2020
K-6 March 2020
K-8 September 2020

PR93A-D2

H-6 November 2018
J-5 January 2019
J-6 September 2019
K-5 January 2020
K-8 September 2020

PR93A-D4

J-5 February 2019
J-6 October 2019
K-5 January 2020
K-6 March 2020

PR93A-D6

H-5 June 2018
J-5 January 2019
J-6 September 2019
K-5 January 2020
K-6 March 2020
K-8 September 2020

***PR67A(-D4) and PR93A(-D2)(-D4)(-D6) Rail Assembly
Reworked Serial Numbers**

PR67A	K60391E, K60392E, K60395E, K60396E K70400F, K70405F K70406G, K70407G K70408G, K70410G, K70414G - K70419G, K70420G - K70429G	PR93A	K60180C, K60184C, K60189C
PR67A-D4	K70137G, K70416G	PR93A-D2	K50032A, K50035B, K50036B, K50037B
		PR93A-D4	K50022A, K50023A, K50024A, K50025B K50026B, K50027B, K60030C, J60016K J60017K, J60018K, J60021K
		PR93A-D6	K50045A, K50047A, K50048B, K50049B, K50050B, K60051C K60052C, K60053C

Auxiliary Code Breakdown

The auxiliary code is the first two characters in the serial number. The first character indicates the year. Years progress or regress in alphabetical order. The series runs from "A" through "V" and the letters "I" and "O" are skipped. The second character indicates significant part changes within a year. Base is "5" and this number advances for each change. In cases where there is a letter in parentheses, this designates the month. This is the last character in the serial number. The series runs from "(A)" through "(M)" and the letter "(I)" is skipped. This designation is only included when identifying a parts change within an auxiliary code.

Note About Ordering Parts

Most assemblies cannot be ordered as complete units; parts in the assemblies generally must be ordered separately.

A. Main Assembly
PR46A(-D2)
 H-5 to K-7

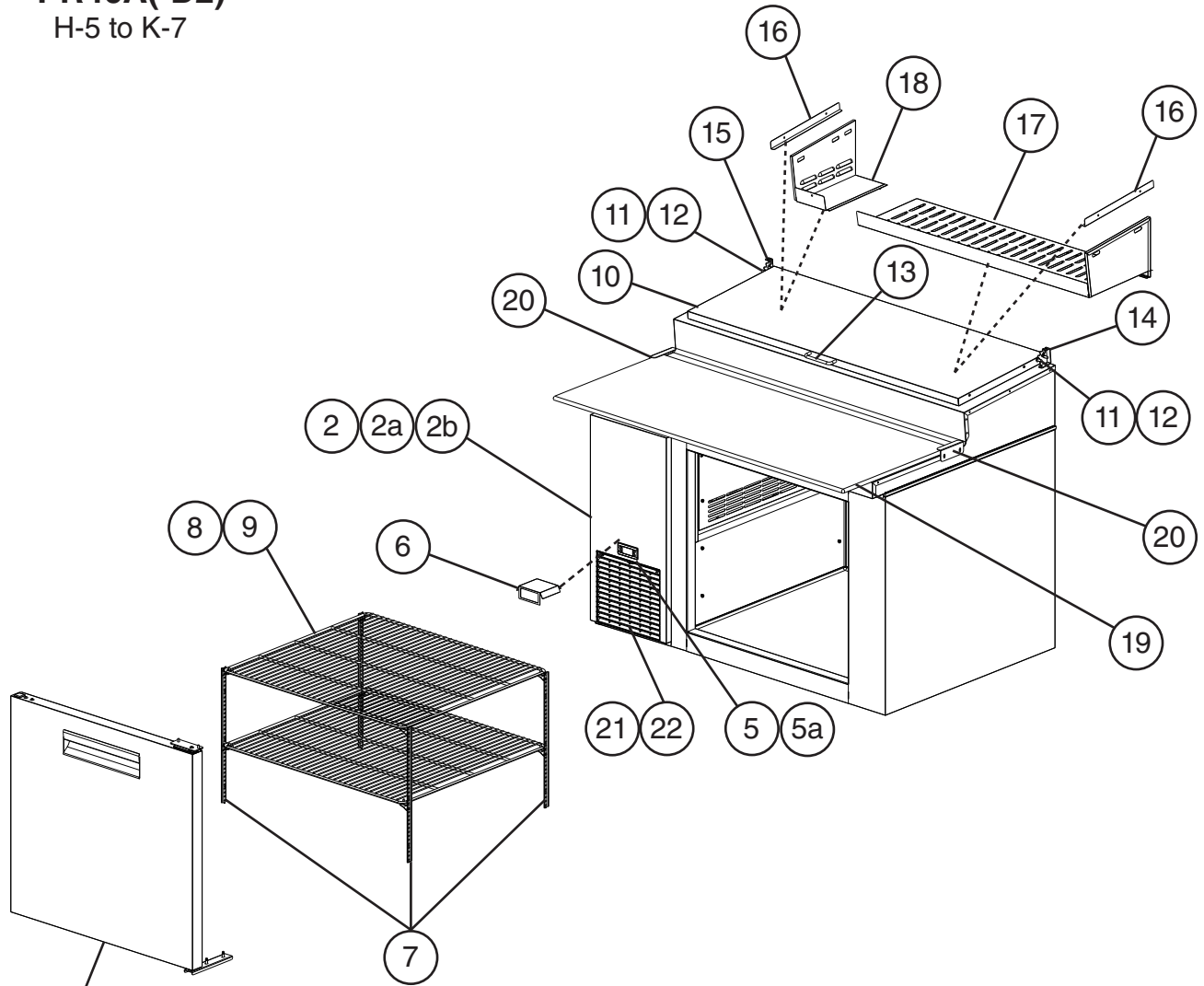

For Door, see Section "C"

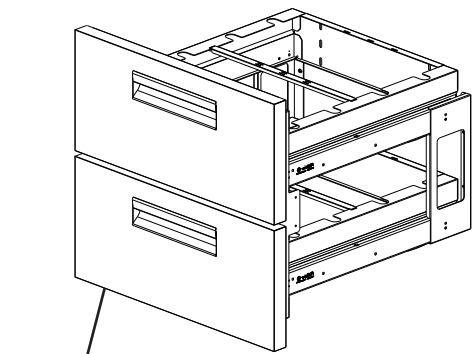

For Drawers, see Section "E"

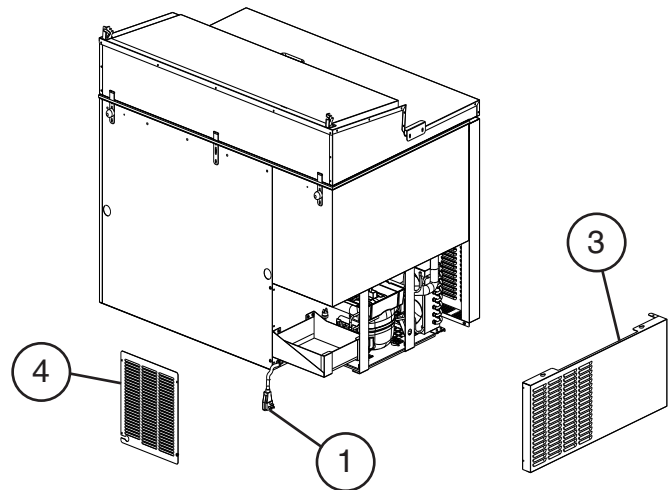

Title: A. Main Assembly Models: PR46A(-D2)

Index No.	Description	Material or Model Number	Part Number	Required Number															
				H-5 J-5	J-6 to K-5	K-6 K-7													
1	Power Supply Cord		4A5718-01	1	1	1													
2	Front Panel	PR46A PR46A-D2	2A8533-01	1	-														
			2A9304-01		1	1													
2a	Front Panel Latch	PR46A PR46A-D2	4A0508-03	2	-														
2b	Front Panel Striker	PR46A PR46A-D2	4A0515-01	2	-														
3	Left Side Panel		2A7902-01	1	1	1													
4	Rear Louver Panel		3A7482-01	1	1	1													
5	Control Module		4A6958G01	1	1	1													
5a	Control Module Retainer		4A5502-01	2	2	2													
6	Deflector		3A9649-01	1	1	1													
7	Pilaster	PR46A	4A5583-01	4	4	4													
8	Shelf	PR46A	3A2830-13	2	2	2													
9	Shelf Clip	PR46A	4A5418-01	8	8	8													
10	Rail Cover (includes items 11,12, and 13)		2A8332A01	1	1	1													
11	Pivot Pin		4A4768-01	4	4	4													
12	Pivot Bolt		4A4769-01	4	4	4													
13	Handle		4A4518-01	1	1	1													
14	Right Rail Cover Bracket		3A9236-01	1	1	-													
			3B0612-02			1													
15	Left Rail Cover Bracket		3A9236-02	1	1	-													
			3B0612-01			1													
16	Pan Support Bracket		3A7687-02	2	2	2													
17	Right Air Duct		1A5295-01	1	1	1													
18	Left Air Duct		2A8907-01	1	1	1													
19	Cutting Board		3A4894-18	1	1	1													
20	Cutting Board Bracket		3A4890-01	2	2	2													
21	Louver		103344-07		1	1													
22	Air Filter		208840G03		1	1													

A. Main Assembly
PR67A(-D2)(-D4)
1/2
 H-5 to K-8

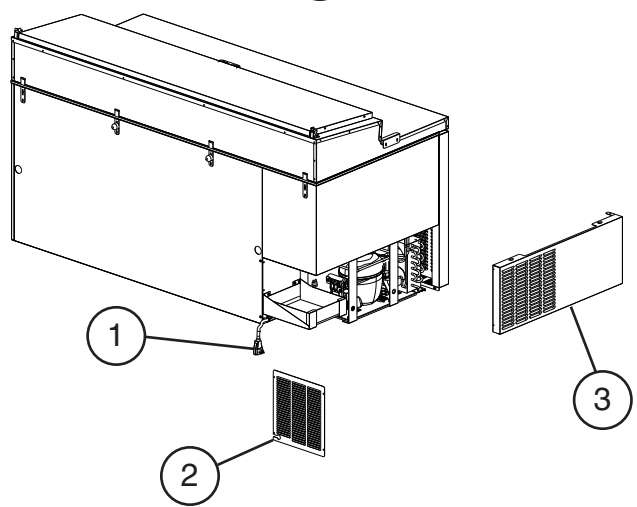
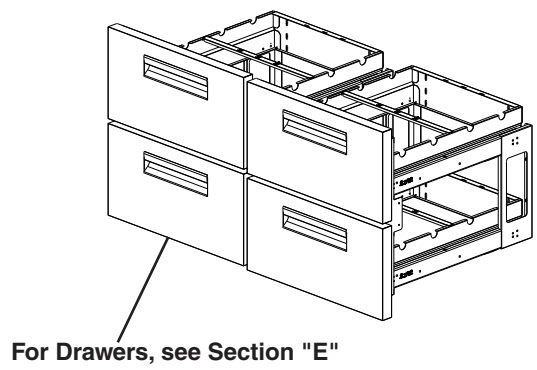
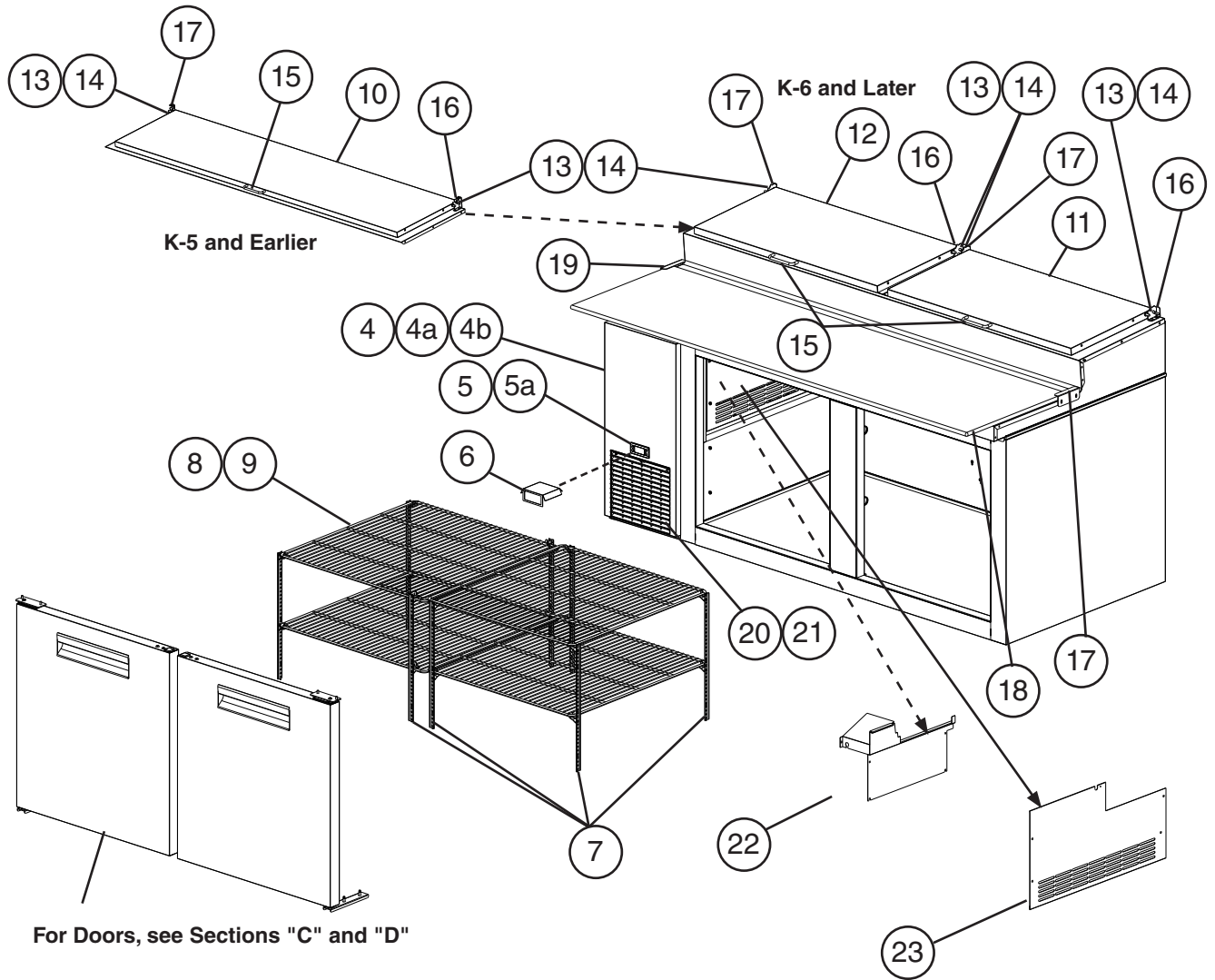

A. Main Assembly
PR67A(-D2)(-D4)
2/2
K-6 - K-8

H-5 to K-7 except serial numbers listed on page 4

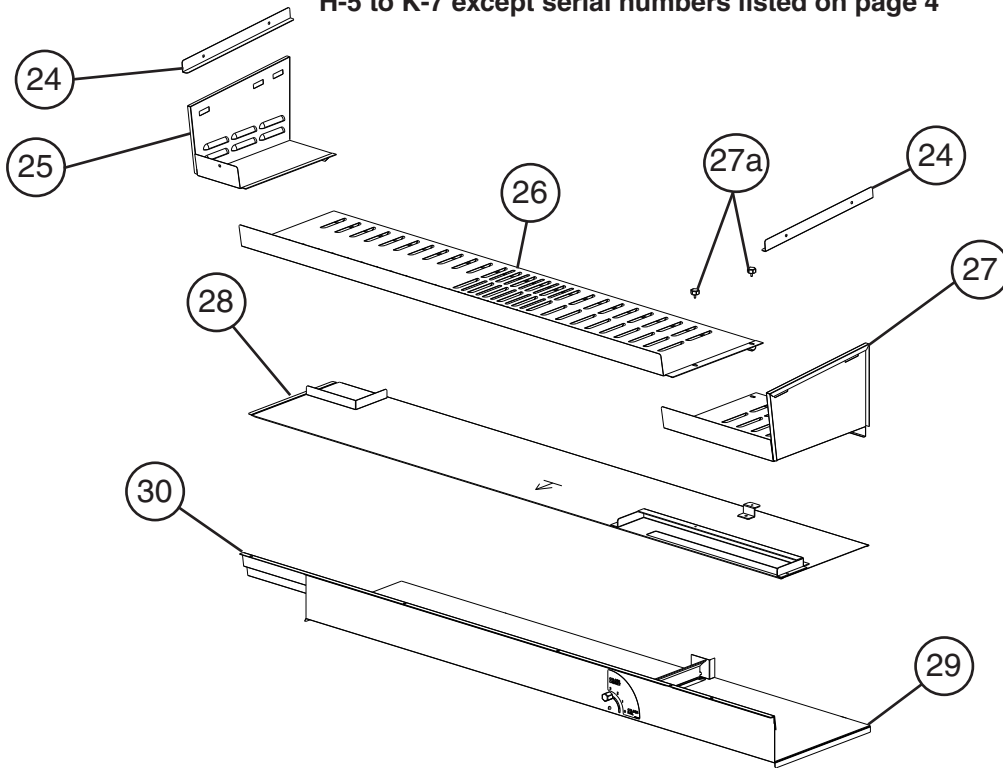

K-8 and Later including serial numbers listed on page 4

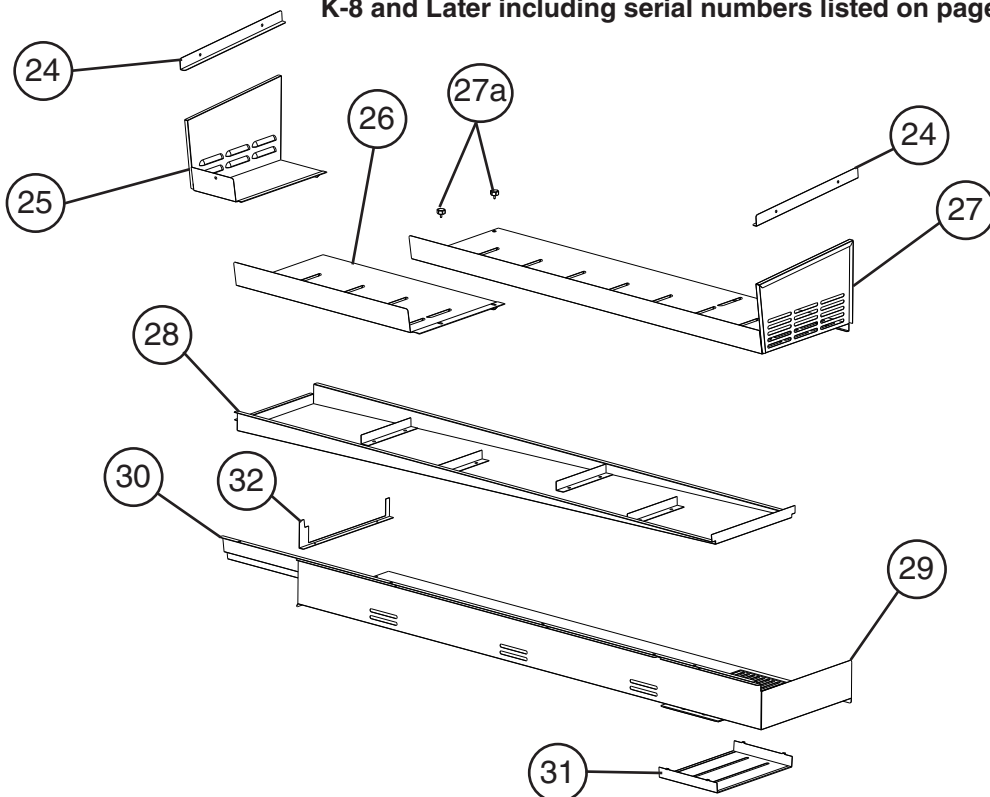

Title: A. Main Assembly Models: PR67A(-D2)(-D4)												
Index No.	Description	Material or Model Number	Part Number	Required Number								
				H-5 to J-5	J-6 to K-5	K-6 K-7	K8					
1	Power Supply Cord		4A5718-01	1	1	1	1					
2	Rear Louver Panel		3A7482-01	1	1	1	1					
3	Left Side Panel		2A7902-01	1	1	1	1					
4	Front Panel		2A8533-01	1	-							
			2A9304-01		1	1	1					
4a	Front Panel Latch		4A0508-03	2	-							
4b	Front Panel Striker		4A0515-01	2	-							
5	Control Module		4A6958G01	1	1	1	1					
5a	Control Module Retainer		4A5502-01	2	2	2	2					
6	Deflector		3A9649-01	1	1	1	1					
7	Pilaster	PR67A	4A5583-01	8	8	8	8					
		PR67A-D2		4	4	4	4					
8	Shelf	PR67A	3A2830-12	4	4	4	4					
		PR67A-D2		2	2	2	2					
9	Shelf Clip	PR67A	4A5418-01	16	16	16	16					
		PR67A-D2		8	8	8	8					
10	Rail Cover (includes items 13, 14, and 15)		2A8334A01	1	1	-						
11	Right Cover (includes items 13, 14, and 15)		2A9578A01			1	1					
12	Left Cover (includes items 13, 14, and 15)		2A9579A01			1	1					
13	Pivot Pin		4A4768-01	4	4	8	8					
14	Pivot Bolt		4A4769-01	4	4	8	8					
15	Handle		4A4518-01	1	1	2	2					
16	Right Rail Cover Bracket		3A9236-01	1	1	-						
			3B0612-02			2	2					
17	Left Rail Cover Bracket		3A9236-02	1	1	-						
			3B0612-01			2	2					
18	Cutting Board		3A4894-17	1	1	1	1					
19	Cutting Board Bracket		3A4890-01	2	2	2	2					
20	Louver		103344-07		1	1	1					
21	Air Filter		208840G03		1	1	1					
22	Evaporator Duct Panel		1A3237-01	1	1	1	-					
			*3B0855G01				1					
23	Evaporator Shroud		1A5756-01	1	1	1	-					
			*1A6228-01				1					

Title: A. Main Assembly Models: PR67A(-D2)(-D4)												
Index No.	Description	Material or Model Number	Part Number	Required Number								
				H-5 to J-5	J-6 to K-5	K-6 to K-7	K8					
*For Reworked Rail Assembly Serial Numbers see Page 4 "Rail Assembly Reworked Serial Numbers"												
24	Pan Support Bracket		3A7687-02	2	2	2	2					
25	Upper Left Air Duct Panel		2A8907-01	1	1	1	-					
			*2A9866-01				1					
26	Upper Center Air Duct Panel		2A8909-01	1	1		-					
			*2A9855-01				1					
27	Upper Right Air Duct Panel		2A8910-01	1	1	1	-					
			*3B0862G01				1					
27a	Thumbscrew		415949G08	2	2	2	2					
28	Middle Ramp Duct Panel		2A8911G01	1	1	1	-					
			*2A9848G01				1					
29	Lower Duct Panel		2A7831G01	1	1	1	-					
			*2A9852G01				1					
30	Middle Ramp Support		2A7802-01	1	1	1	-					
			*2A9850-01				1					
31	Air Deflector		*3B0892G01				1					
32	Air Block		*3B0890-01				1					

A. Main Assembly
PR93A(-D2)(-D4)(-D6)
1/2
 H-5 to K-8

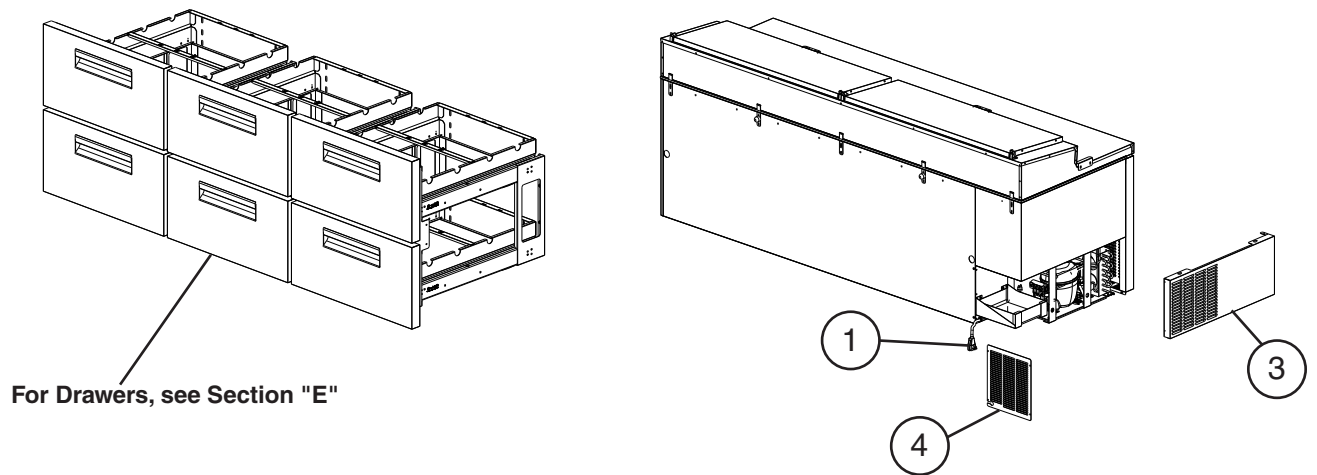
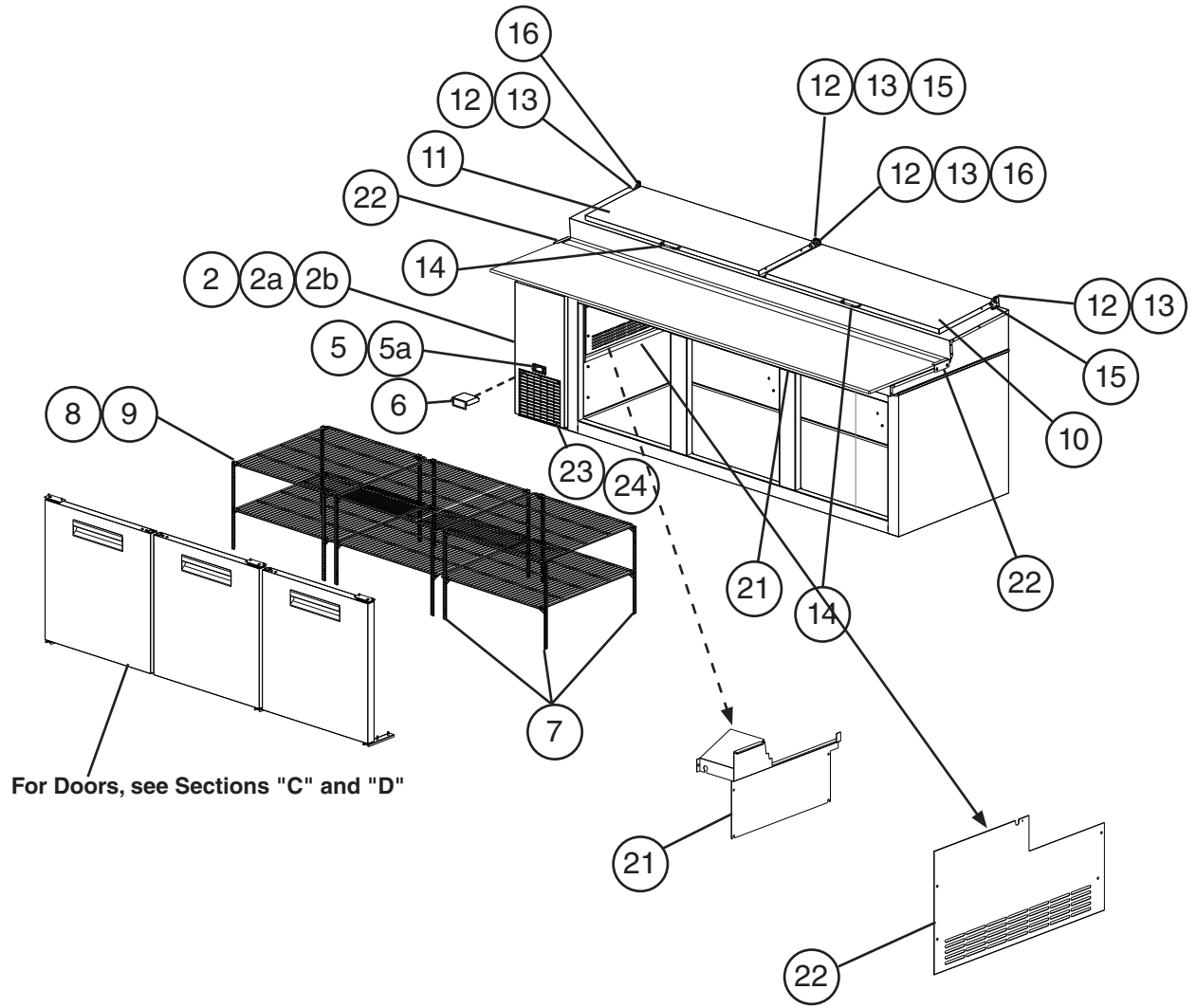

A. Main Assembly PR93A(-D2)(-D4)(-D6)

2/2

H-5 to K-8

H-5 to K-7 Except serial numbers listed on page 4

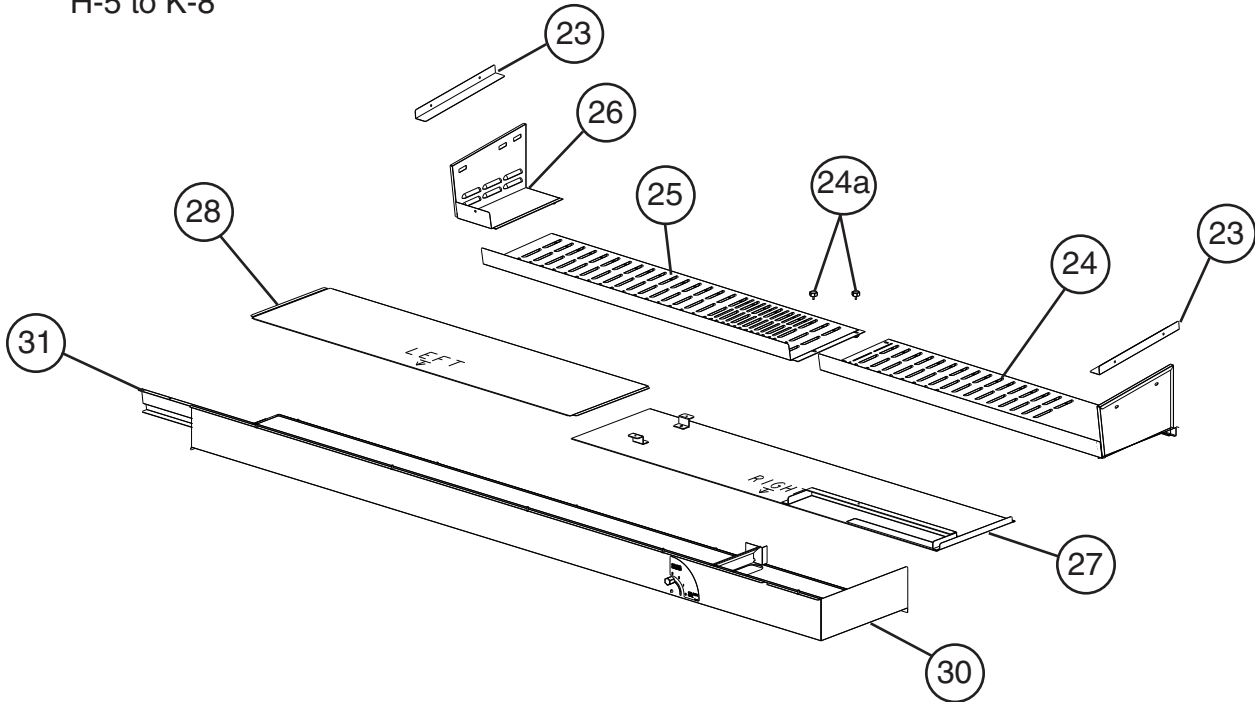

K-8 and Later including serial numbers listed on page 4

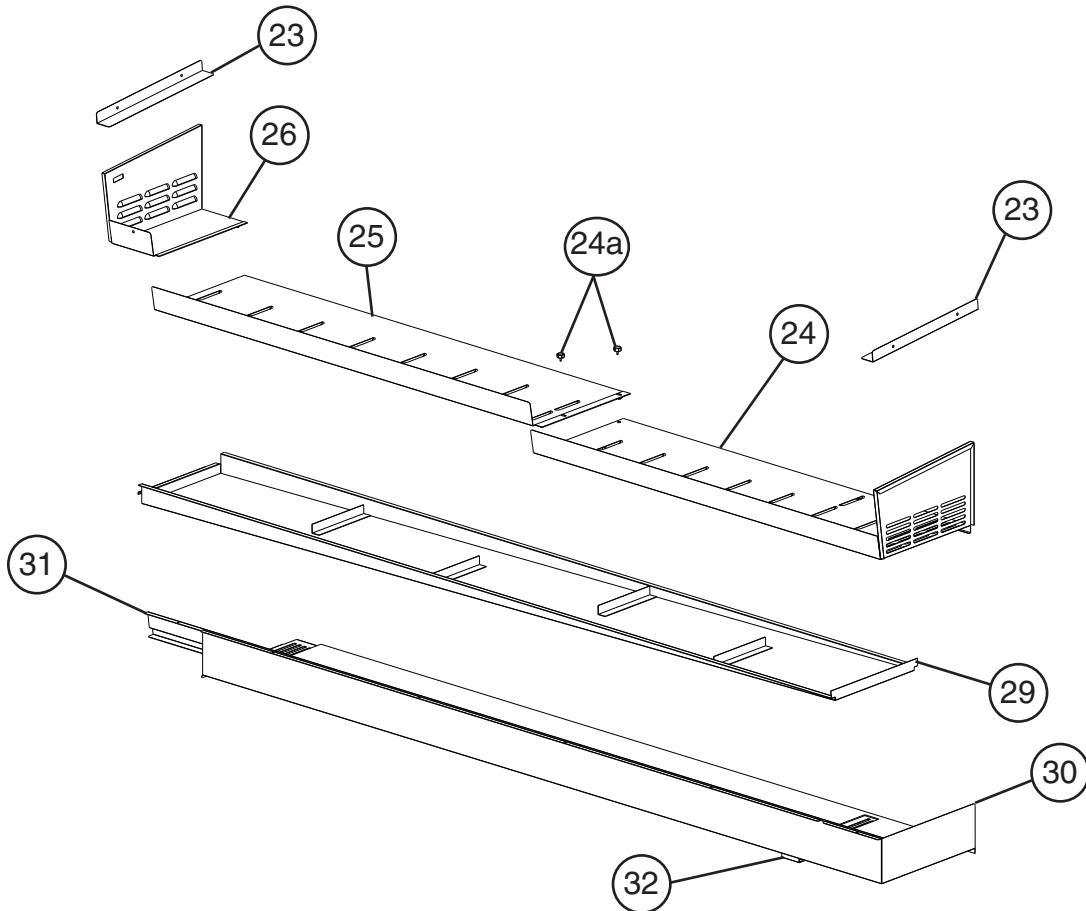

Title: A. Main Assembly Models: PR93A(-D2)(-D4)(-D6)												
Index No.	Description	Material or Model Number	Part Number	Required Number								
				H-5 to J-5	*J-6 to *K-5	*K-6 to K-7	*K-8					
1	Power Supply Cord		4A5718-01	1	1	1	1					
2	Front Panel		2A8533-01	1	-							
			2A9304-01		1	1	1					
2a	Front Panel Latch		4A0508-03	2	-							
2b	Front Panel Striker		4A0515-01	2	-							
3	Left Side Panel		2A7902-01	1	1	1	1					
4	Rear Louver Panel		3A7482-01	1	1	1	1					
5	Control Module		4A6958G01	1	1	1	1					
5a	Control Module Retainer		4A5502-01	2	2	2	2					
6	Deflector		3A9649-01	1	1	1	1					
7	Pilaster	PR93A	4A5583-01	12	12	12	12					
		PR93A-D2		8	8	8	8					
		PR93A-D4		4	4	4	4					
8	Shelf	PR93A	3A2830-12	6	6	6	6					
		PR93A-D2		4	4	4	4					
		PR93A-D4		2	2	2	2					
9	Shelf Clip	PR93A	4A5418-01	24	24	24	24					
		PR93A-D2		16	16	16	16					
		PR93A-D4		8	8	8	8					
10	Right Rail Cover (includes 1/2 quantity of items 12, 13, and 14)		2A8336A01	1	1	-						
			2A9575A01			1	1					
11	Left Rail Cover (includes 1/2 quantity of items 12, 13, and 14)		2A8337A01	1	1	-						
			2A9576A01			1	1					
12	Pivot Pin		4A4768-01	8	8	8	8					
13	Pivot Bolt		4A4769-01	8	8	8	8					
14	Handle		4A4518-01	2	2	2	2					
15	Right Rail Cover Bracket		3A9236-01	2	2	-						
			3B0612-02			2	2					
16	Left Rail Cover Bracket		3A9236-02	2	2	-						
			3B0612-01			2	2					
17	Louver		103344-07		1	1	1					
18	Air Filter		208840G03		1	1	1					
19	Cutting Board		3A4894-16	1	1	1	1					
20	Cutting Board Bracket		3A4890-01	2	2	2	2					

Title: A. Main Assembly Models: PR93A(-D2)(-D4)(-D6)

Index No.	Description	Material or Model Number	Part Number	Required Number							
				H-5 to J-5	*J-6 to *K-5	*K-6 to K-7	*K-8				
*For Reworked Rail Assembly Serial Numbers see Page 4 "Rail Assembly Reworked Serial Numbers"											
21	Evaporator Duct Panel		1A3237-01	1	1	1	-				
			*3B0855G01				1				
22	Evaporator Shroud		1A5756-01	1	1	1	-				
			*1A6228-01				1				
23	Pan Support Bracket		3A7687-01	2	2	2	2				
24	Upper Right Air Duct Panel		2A8915-01	1	1	1	-				
			*3B0862G01				1				
24a	Thumbscrew		415949G08	2	2	2	2				
25	Upper Center Air Duct Panel		2A8914-01	1	1	1	-				
			*2A9827-01				1				
26	Upper Left Air Duct Panel		2A8907-01	1	1	1	-				
			*2A9826-01				1				
27	Right Middle Ramp Duct Panel		2A8111-01	1	1	1	-				
28	Left Middle Ramp Duct Panel		2A8917-01	1	1	1	-				
29	Middle Ramp Duct Panel		*2A9823G01				1				
30	Lower Duct Panel		2S8102A01	1	1	1	-				
			*2A9825G01				1				
31	Middle Ramp Support		2A8110-01	1	1	1	-				
			*2A9829-01				1				
32	Air Deflector		*3B0883-01				1				

B. Refrigeration Circuit

PR46A(-D2), PR67A(-D2)(-D4), PR93A(-D2)(-D4)(-D6)

H-5 to K-8

* PR67A(-D2)(-D4) Reworked Evaporator Fan Motors, Wick, and Wick Bracket
Serial Numbers K-8 and later including serial numbers listed on page 4
"Rail Assembly Reworked Serial Numbers"

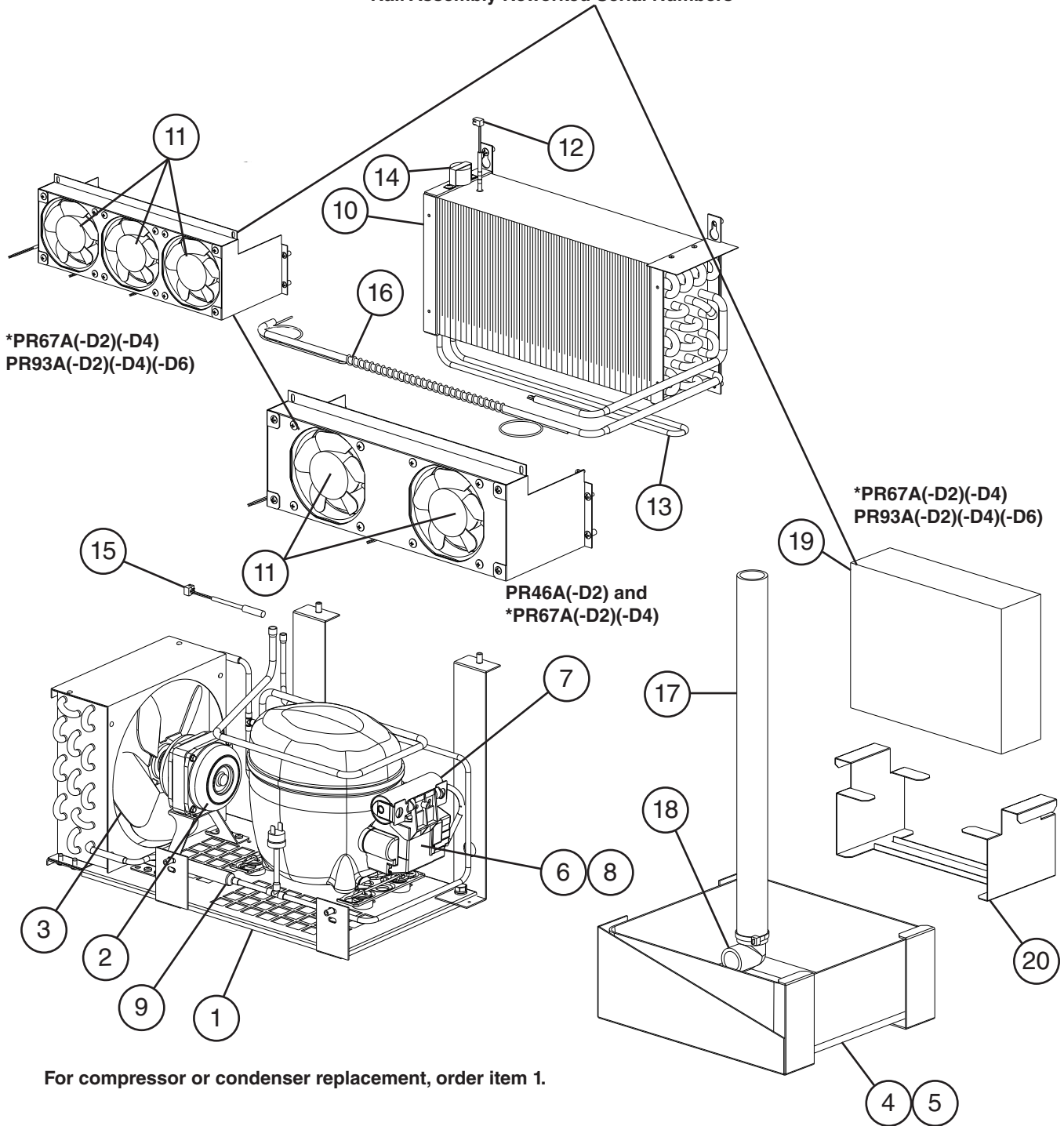

Title: B. Refrigeration Circuit Models: PR46A(-D2), PR67A(-D2)(-D4), PR93A(-D2)(-D4)(-D6)											
Index No.	Description	Material or Model Number	Part Number	Required Number							
				H-5 to J-5	J-6 to K-7	K-8					
1	Condensing Unit (includes compressor, condenser, and items 2 through 8; compressor and condenser are not sold individually)	PR46A(-D2), PR67A(-D2)(-D4)	3A9313-01	1	1	1					
		PR93A(-D2)(-D4)(-D6)	3A9923-01	1	1	1					
2	Condenser Fan Motor	PR46A(-D2), PR67A(-D2)(-D4)	3A6798-01	1	1	1					
	Condenser Fan Motor (includes fan blade)	PR93A(-D2)(-D4)(-D6)	3B0182-01	1	1	1					
3	Condenser Fan Blade		3A6799-01	1	1	1					
4	Condensate Pan		1A3373-01	1	1	1					
5	Condensate Pan Bracket	Right	1A3374-01	1	1	1					
		Left	1A3374-02	1	1	1					
6	Compressor External Protector		3B0232-01	1	1	1					
7	Start Capacitor	378-454 MFD, 165V	3A6938-01	1	1	1					
8	Start Relay		3A6937-01	1	1	1					
9	Drier		4A5576-01	1	1	1					
10	Evaporator		2A7531-01	1	1	1					
11	Evaporator Fan Motor *For Reworked Serial Numbers See Page 4 "Rail Assembly Reworked Serial Numbers"	PR46A(-D2)	4A5343-01	2	2	2					
		*PR67A(-D2)(-D4)		2	2	-					
		PR93A(-D2)(-D4)(-D6)		3	3	3					
12	Defrost Thermistor		4A4865-02	1	1	1					
13	Defrost Heater		3A6443-01	1	1	1					
14	Defrost Safety Thermostat		4A0954-02	1	1	1					
			4A4864-01	1	-	-					
15	Cabinet Thermistor		4A4864-02		1	1					
16	Heat Exchanger	PR46A(-D2), PR67A(-D2)(-D4)	2A8873G01	1	1	1					
		PR93A(-D2)(-D4)(-D6)	3A9925G01	1	1	1					
17	Drain Tube		4A0658L01	1	1	1					
18	Drain Elbow		4A5624-01	1	1	1					
19	Wick *For Reworked Serial Numbers See Page 4 "Rail Assembly Reworked Serial Numbers"	*PR67A(-D2)(-D4)	4A5883-01			*1					
		PR93A(-D2)(-D4)(-D6)		1	1	1					
20	Wick Bracket *For Reworked Serial Numbers See Page 4 "Rail Assembly Reworked Serial Numbers"	*PR67A(-D2)(-D4)	2A7630-01			*1					
		PR93A(-D2)(-D4)(-D6)		1	1	1					

C. Door-Right Hinged PR46A, PR67A(-D2), PR93A(-D2)(-D4)

H-5 to K-8

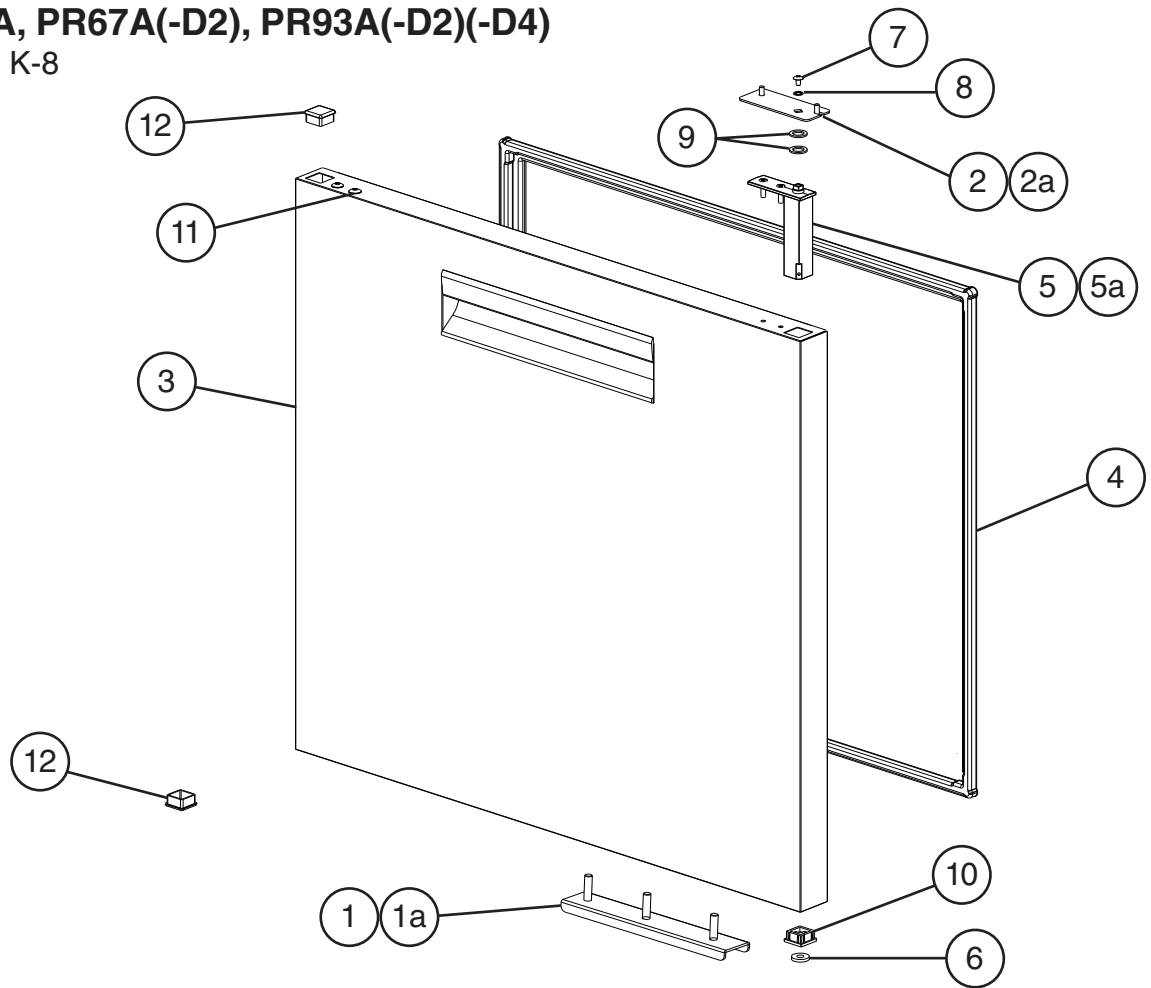

Title: C. Door-Right Hinged Models: PR46A, PR67A(-D2), PR93A(-D2)(-D4)																				
Index No.	Description	Material or Model Number	Part Number	Required Number																
				H-5 to K-8																
1	Lower Hinge Bracket		3A6681G01	1																
1a	Hex Head Tapping Bolt		4A5213-01	2																
2	Upper Hinge Bracket		3A6810-01	1																
2a	Truss Head Screw	5x12, SS	7C32-0512	2																
3	Door Assembly (includes items 4 through 12)	PR46A	2A9409G04	1																
		PR67A(-D2) PR93A(-D2)(-D4)	2A9409G01	1																
4	Gasket	PR46A	2A6996-12	1																
		PR67A(-D2) PR93A(-D2)(-D4)	2A6996-10	1																
5	Hinge Spring Cartridge (includes items 6 through 10)		3A9206-01	1																
5a	Countersunk Screw	5x20, SS	7C42-0520	2																
6	Thrust Washer		4A5234-01	1																
7	Screw		4A5230-01	1																
8	Lock Washer		4A5231-01	1																
9	Thrust Washer		4A5233-01	2																
10	Bearing		4A5232-01	1																
11	Truss Head Screw (filler screws)	5x10	7C32-0510	2																
12	End Cap		4A5432-01	2																

D. Door-Left Hinged
PR67A, PR93A
H-5 to K-8

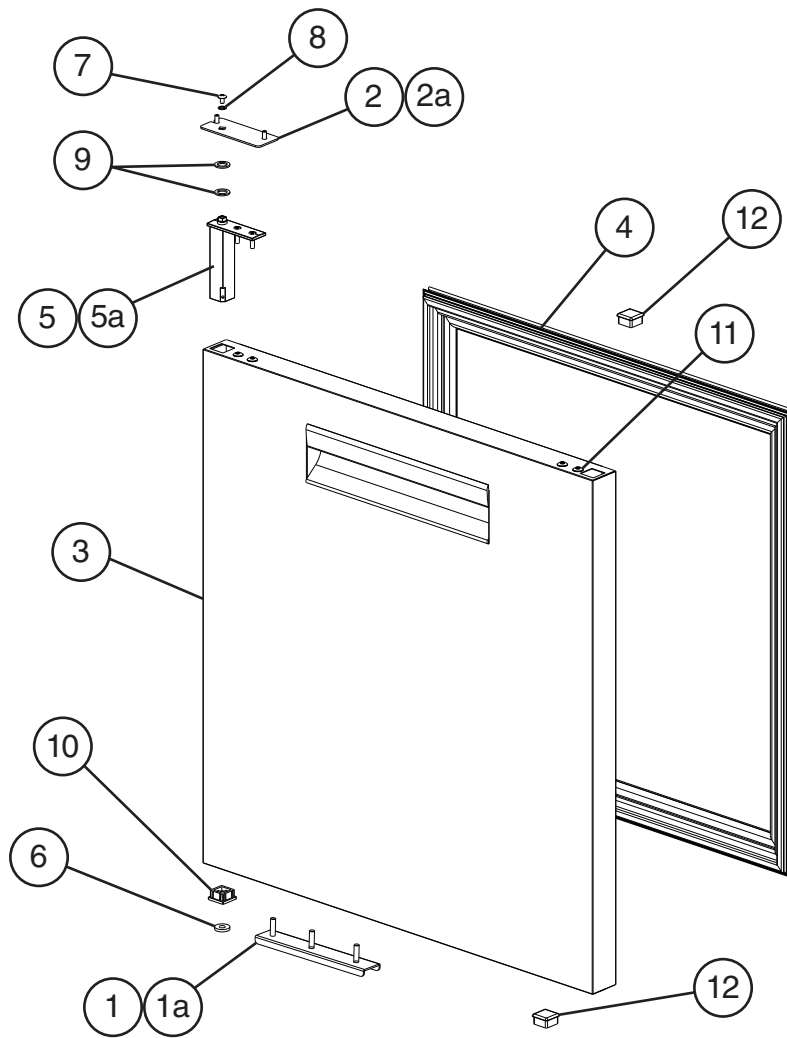

Title: D. Door-Left Hinged Models: PR67A, PR93A					Required Number							
Index No.	Description	Material or Model Number	Part Number	H-5 to K-8								
1	Lower Hinge Bracket		3A6681G01	1								
1a	Hex Head Tapping Bolt		4A5213-01	2								
2	Upper Hinge Bracket		3A6810-01	1								
2a	Truss Head Screw	5x12, SS	7C32-0512	2								
3	Door Assembly (includes items 4 through 12)		2A9411G05	1								
4	Gasket		2A6996-10	1								
5	Hinge Spring Cartridge (includes items 6 through 10)		3A9206-01	1								
5a	Countersunk Screw		7C42-0520	2								
6	Thrust Washer		4A5234-01	1								
7	Screw		4A5230-01	1								
8	Lock Washer		4A5231-01	1								
9	Thrust Washer		4A5233-01	2								
10	Bearing		4A5232-01	1								
11	Truss Head Screw (filler screws)		7C32-0510	2								
12	End Cap		4A5432-01	2								

E. Drawer Assembly

PR46A-D2, PR67A-D2(-D4), PR93A-D2(-D4)(-D6)

H-5 to K-8

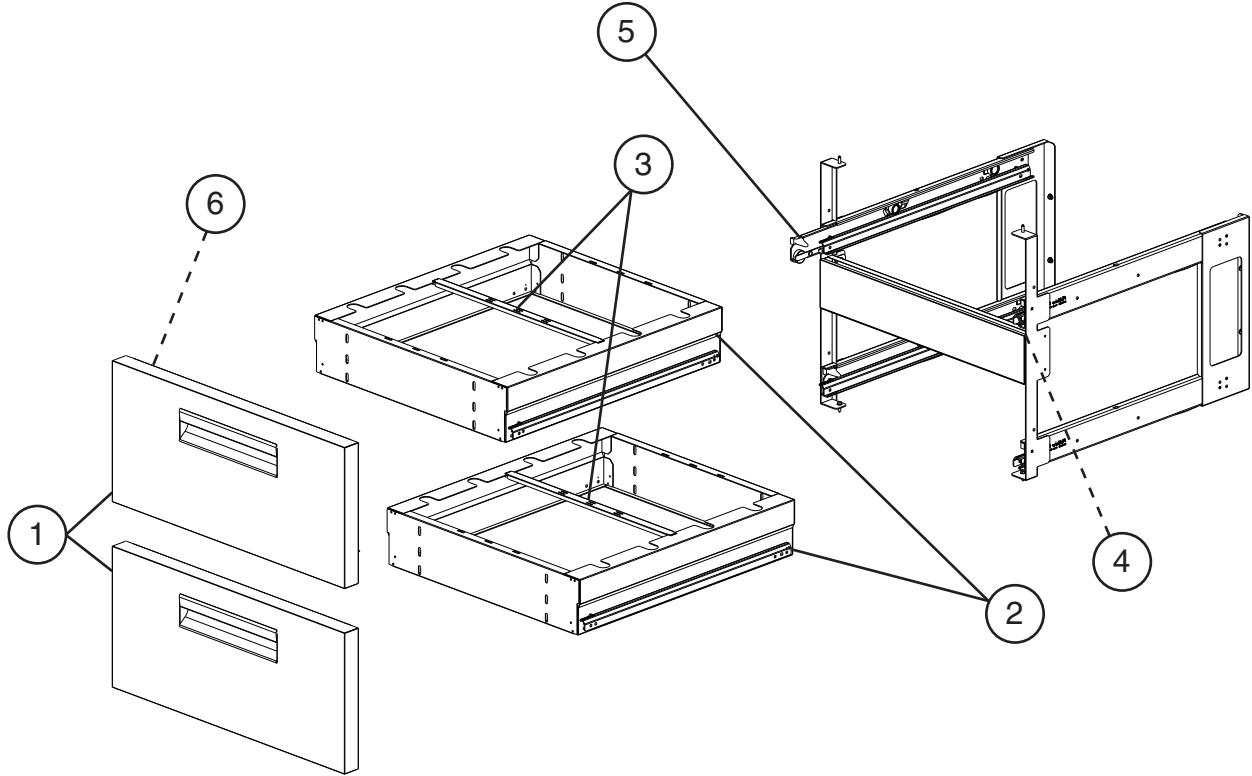

Title: E. Drawer Assembly Models: PR46A-D2, PR67A-D2(-D4), PR93A-D2(-D4)(-D6) Drawer Models										
Index No.	Description	Material or Model Number	Part Number	Required Number Per Section						
				H-5 to K-8						
1	Drawer Face	PR46A-D2	2A9760G01	2						
		PR67A-D2 PR67A-D4 PR93A-D2 PR93A-D4 PR93A-D6	2A9736G01	2						
2	Drawer Box	PR46A-D2	2A7236G01	2						
		PR67A-D2 PR67A-D4 PR93A-D2 PR93A-D4 PR93A-D6	2A7319G01	2						
3	Drawer Divider		3B0029-02	2						
4	Right Side Roller		4A5674-02	2						
5	Left Side Roller		4A5674-05	2						
6	Drawer Gasket	PR46A-D2	2A5192-16	2						
		PR67A-D2 PR67A-D4 PR93A-D2 PR93A-D4 PR93A-D6	2A5192-15	2						

F. Accessories & Labels

PR46A(-D2), PR67A(-D2)(-D4), PR93A(-D2)(-D4)(-D6)

H-5 to K-8

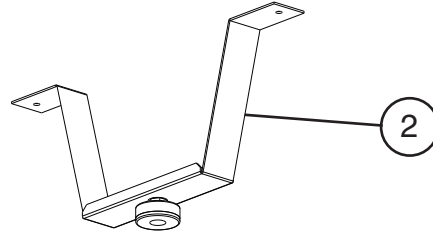
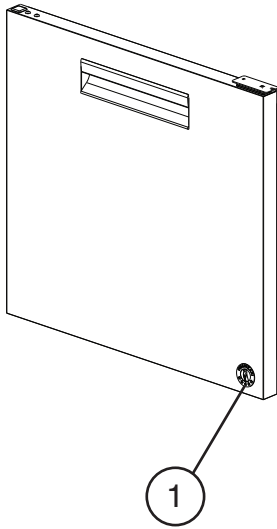

Title: F. Accessories & Labels Models: PR46A(-D2), PR67A(-D2)(-D4), PR93A(-D2)(-D4)(-D6)										
Index No.	Description	Material or Model Number	Part Number	Required Number						
				H-5 to K-8						
1	Penguin Label		475552L01	1						
2	Anti-Tip Bracket	PR46A(-D2)	3A8203A01	1						
3	6" Caster Kit (includes items 4 and 5)	HS-5036	4A5435A01	1						
4	6" Non-Locking Caster	PR46A(-D2) PR67A(-D2) PR67A(-D4)	4A5428-01	2						
		PR93A(-D2) PR93A(-D4) PR93A(-D6)		3						
5	6" Locking Caster	PR46A(-D2) PR67A(-D2) PR67A(-D4)	4A5428-02	2						
		PR93A(-D2) PR93A(-D4) PR93A(-D6)		3						
6	1/3 Size Pan, 4" Depth	PR46A(-D2)	1000000351	6						
		PR67A(-D2) PR67A(-D4)		9						
		PR93A(-D2) PR93A(-D4) PR93A(-D6)		12						
7	Pan Divider	PR46A(-D2)	3A4934-01	6						
		PR67A(-D2) PR67A(-D4)		9						
		PR93A(-D2) PR93A(-D4) PR93A(-D6)		12						