



750-CTUS



- **Installation**
- **Operation**
- **Maintenance**

W164 N9221 Water Street • P.O. Box 450
Menomonee Falls, Wisconsin 53052-0450 U.S.A.

PHONE: 262.251.3800 • 800.558.8744 U.S.A. / CANADA
FAX: 262.251.7067 • 800.329.8744 U.S.A. ONLY
www.alto-shaam.com



Consult instructions
for operation and use.



Table of Contents

Delivery	3
Transportation and Damage Claims.....	4
Unpacking	5
Safety Procedures.....	6
Installation	8
Dimensions.....	10
Electrical Connections	11
Operating Instructions.....	12
General Holding Guidelines	13
Food Safety	14
Cleaning and Preventative Maintenance	15
Service.....	17
Wiring Diagrams	19
Limited Warranty	22

This Alto-Shaam appliance has been thoroughly tested and inspected to ensure only the highest quality appliance is provided. Upon receipt, check for any possible shipping damage and report it at once to the delivering carrier. See Transportation Damage and Claims section located in this manual.

This appliance, including unattached items and accessories, may be delivered in one or more packages. Ensure all standard items and options have been received with each appliance as ordered. Save all the information packed with the appliance. Register the appliance online at www.alto-shaam.com/en/support/warranty-registration to ensure prompt service in the event of a warranty parts and labor claim.

This manual must be read and understood by all people using or installing the appliance. Contact the Alto-Shaam Tech Team Service Department if you have any questions concerning installation, operation, or maintenance.

1-800-558-8744; servicedept@alto-shaam.com

The serial number is required for all inquiries.

Always include both model and serial number(s) in any correspondence regarding the appliance.

Model: _____

Serial number: _____

Purchased from: _____

Date installed: _____ **Voltage:** _____

CAUTION

Appliance and accessories may be heavy. To prevent serious injury, **always** use a sufficient number of trained and experienced workers when moving or leveling appliance and handling accessories.

Environmental Conditions

- Operational Environmental Conditions
- Before use, appliance must acclimate to room temperature in the environment it is placed – 24 hours is recommended.
 - Ambient temperature range of 60°F to 110°F (16°C to 43°C).
 - Relative humidity of less than 95% non-condensation.
 - Atmospheric pressure range of 50kPa to 106kPa.

Transportation and Damage Claims



All Alto-Shaam equipment is sold Free on Board (F.O.B.) shipping point, and when accepted by the carrier, such shipments become the property of the consignee.

Should damage occur in shipment, do not put the appliance into service until the damage has been inspected by an authorized Alto-Shaam service provider.

Shipping damages are a matter between the carrier and the consignee. In such cases, the carrier is assumed to be responsible for the safe delivery of the merchandise, unless negligence can be established on the part of the shipper.

1. Make an immediate inspection while the appliance is still in the truck or immediately after it is moved to the receiving area. Do not wait until after the appliance is moved to a storage area.
2. Do not sign a delivery receipt or a freight bill until a proper count has been made and inspection of all appliances are received.

3. Note all damage to packages directly on the carrier's delivery receipt.
4. Make certain the driver signs the delivery receipt. If the driver refuses to sign, make a notation of this refusal on the receipt.
5. If the driver refuses to allow inspection, write the following on the delivery receipt: **Driver refuses to allow inspection of containers for visible damage.**
6. Contact the carrier's office immediately upon finding damage, and request an inspection. Mail a written confirmation to the carrier's office with the time, date, and the person called.
7. Save any packages and packing material for further inspection by the carrier.
8. Promptly file a written claim with the carrier and attach copies of all supporting paperwork.

Alto-Shaam will continue our policy of assisting our customers in collecting claims which have been properly filed and actively pursued. Alto-Shaam cannot, however, file any damage claims, assume the responsibility of any claims, or accept deductions in payment for such claims.

Record the model and serial number of the appliance for easy reference. Always refer to both model and serial number in any contact with Alto-Shaam regarding this appliance.

Model: _____

Serial Number: _____

Date Installed: _____

Voltage: _____

Purchased From: _____



Alto-Shaam has established a twenty-four hour emergency service call center to offer immediate customer access to a local authorized service agency outside of standard business hours. The emergency service access is provided exclusively for Alto-Shaam equipment and is available throughout the United States through the use of Alto-Shaam's toll-free number. Emergency service access is available seven days a week including holidays.

- Carefully remove the appliance from the carton or crate.

NOTE: Do not discard the carton and other packaging material until you have inspected the appliance for hidden damage and tested it for proper operation.

Do not discard this manual. This manual is considered to be part of the appliance and is to be provided to the owner or manager of the business or to the person responsible for training operators. Additional manuals are available from the manufacturer.

- Read all instructions in this manual carefully before installing this appliance, using the appliance or performing routine maintenance. Following procedures other than those indicated in this guide to use and clean the appliance is considered inappropriate and may cause damage, injury or fatal accidents, in addition to voiding the warranty and relieving Alto-Shaam of all liability.
- Remove all protective plastic film, packaging materials, and accessories from the appliance before connecting electrical power. Store any accessories in a convenient place for future use.

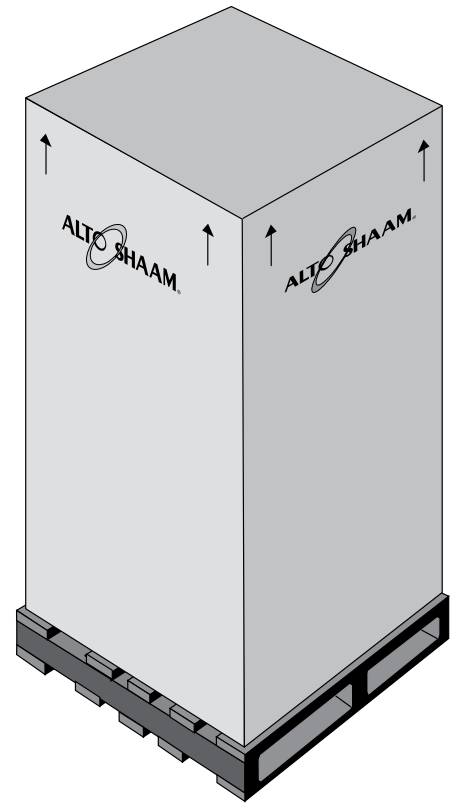

Safety Procedures

- The appliance is intended to cook, hold or process foods for the purpose of human consumption. No other use for this appliance is authorized and is therefore considered dangerous. The appliance must not be used to cook food containing flammable materials (such as food with alcohol). Substances with a low flash point can ignite spontaneously and cause a fire.
- The appliance is intended for use in commercial establishments where all operators are familiar with the purpose, limitations, and associated hazards of this appliance. Operating instructions and warnings must be read and understood by all operators and users. Alto-Shaam recommends regular staff training to avoid the risk of accident or damage to the appliance. Operators must also receive regular safety instructions.
- Any troubleshooting guides, component views, and parts lists included in this manual are for general reference only and are intended for use by qualified and trained technicians.
- This manual should be considered a permanent part of this appliance. This manual and all supplied instructions, diagrams, schematics, parts lists, notices, and labels must remain with the appliance if the item is sold or moved to another location.

NOTICE: For equipment delivered for use in any location regulated by the following directive: 2012/95/EC WEEE



Do not dispose of electrical or electronic equipment with other municipal waste.

Knowledge of proper procedures is essential to the safe operation of electrically and/or gas energized equipment. The following signal words and symbols may be used throughout this manual.

DANGER

Indicates a hazardous situation that, if not avoided, will result in death or serious injury.

WARNING

Indicates a hazardous situation that, if not avoided, could result in death or serious injury.

CAUTION

Indicates a hazardous situation that, if not avoided, could result in minor or moderate injury.

NOTICE: Indicates information considered important, but not hazard-related (e.g., messages relating to property damage).



Indicates that referral to operating instructions is a mandatory action. If not followed the operator could suffer personal injury.



Indicates that referral to operating instructions is recommended to understand operation of equipment.

- To prevent serious injury, death or property damage, the appliance should be inspected and serviced at least every twelve (12) months by an authorized service partner or trained technician.
- **Only** allow an authorized service partner or trained technician to service or to repair the appliance. Installation or repairs that are not performed by an authorized service partner or trained technician, or the use of non-factory authorized parts will void the warranty and relieve Alto-Shaam of all liability.
- When working on this appliance, observe precautions in the literature, on tags, on labels attached to or shipped with the appliance and other safety precautions that may apply.
- If the appliance is installed on casters, freedom of movement of the appliance must be restricted so that utility connections (including gas, water, and electricity) cannot be damaged when the appliance is moved. If the appliance is moved, ensure that all utility connections are properly disconnected. If the appliance is returned to its original position, ensure that retention devices and utility connections are properly connected.
- **Only** use the appliance when it is stationary. Mobile appliance racks, mobile plate racks, transport trolleys, and appliances on casters can tip over when being moved over an uneven floor or threshold and cause serious injury.
- **Always** apply caster brakes on mobile appliances or accessories when these are not being moved. These items could move or roll on uneven floors and cause property damage or serious injury.
- Be extremely careful when moving appliances because the food trays may contain hot fluids that may spill, causing serious injury.

WARNING



To prevent **serious personal injury, death, or property damage:**

The appliance must be cleaned thoroughly to avoid deposits of grease and or food residue inside the appliance that may catch fire. If fat deposits and/or food waste inside the appliance ignite, shut down the appliance immediately and keep the appliance door closed to extinguish the fire. If further extinguishing is required, disconnect the appliance from the main power and use a fire extinguisher (do not use water to extinguish a grease fire!). Failure to clean the appliance properly invalidates the warranty and relieves Alto-Shaam of all liability.

WARNING

This appliance is not intended for use by persons (including children) with reduced physical, sensory or mental capabilities, or lack of experience and knowledge, unless they have been given supervision concerning use of the appliance by person responsible for their safety.

Children should be supervised to ensure that they do not play with the appliance.

Installation

⚠️ WARNING

Improper installation, alteration, adjustment, service, cleaning, or maintenance could result in property damage, severe injury, or death.

Read and understand the installation, operating and maintenance instructions thoroughly before installing, servicing, or operating this equipment.

⚠️ CAUTION



Appliance and accessories may be heavy. To prevent serious injury, **always** use a sufficient number of trained and experienced workers when moving or leveling appliance and handling accessories.

⚠️ CAUTION



To prevent **personal injury** or **property damage**:

Always use hand protection when operating this appliance to avoid burns. Metal parts of this equipment become extremely hot when in operation.

⚠️ WARNING



To prevent personal injury, death or property damage:

Do not store or use gasoline or other flammable vapors or liquids in the vicinity of this or any other appliance.

The Alto-Shaam Holding Cabinet must be installed in a location that will permit the oven to function for its intended purpose and to allow adequate clearance for ventilation, proper cleaning, and maintenance access.

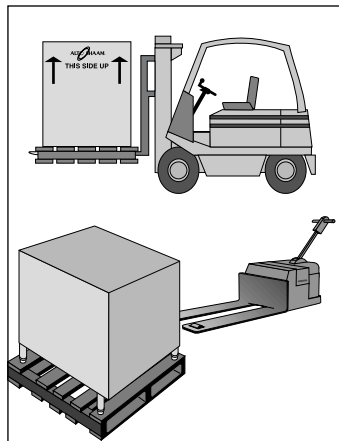

1. The Holding Cabinet must be installed on a stable and level surface.
2. **Do not** install this appliance in any area where it may be affected by any adverse conditions such as steam, grease, dripping water, high temperatures, or any other severely adverse conditions.
3. **Do not** store or use any flammable liquids or allow flammable vapors in the vicinity of this oven or any other appliance.
4. This appliance must be kept free and clear of any combustible materials.
5. This appliance must be kept free and clear of any obstructions blocking access for maintenance or service.

Emissions testing conducted by Underwriters Laboratories, Inc.® was found to be in compliance with the applicable requirements of NFPA96: 2004 Edition, Par. 4.1.1.2. U.L emissions sampling of grease laden vapor resulted in a total of 0.55 milligrams per cubic meter with no visible smoke and is considered representative of all oven models in the line. Based on these results, hood installation and/or outside venting should not be a requirement in most areas. Verify local codes for locations where more restrictive codes are applicable.

Clearance Requirements	
Back	3" (76mm)
Top	2" (51mm)
Right Side, Left Side	1" (25mm)

User Safety Information

This appliance is intended for use in commercial establishments where all operators are familiar with the purpose, limitations, and associated hazards of this appliance. Operating instructions and warnings must be read and understood by all operators and users.

1. Unit must be connected to the appropriate power source.
2. Use hand protection when handling hot items.
3. Preheat the unit for 30 minutes before use.
4. Be certain only hot foods are placed into the unit.

Before Initial Use

1. Clean both the interior and exterior of the unit with a damp, clean cloth and mild soap solution. Rinse carefully.
2. Clean and install the cabinet side racks. Shelves should be positioned with the curved end up and toward the back of the unit (reach-in models).

 CAUTION	
	<p>To prevent personal injury or property damage:</p> <p>Always use hand protection when operating this appliance to avoid burns. Metal parts of this equipment become extremely hot when in operation.</p>

Heating Characteristics

The cabinet is equipped with a special heating cable. Through this Halo Heat concept, the heating cable is mounted against the walls of the unit to provide an evenly applied heat source controlled by a thermostat. The design and operational characteristics of the unit eliminate the need for a moisture pan or a heat circulating fan. Through even heat application, the quality of food products is maintained up to several hours or more.

Dimensions

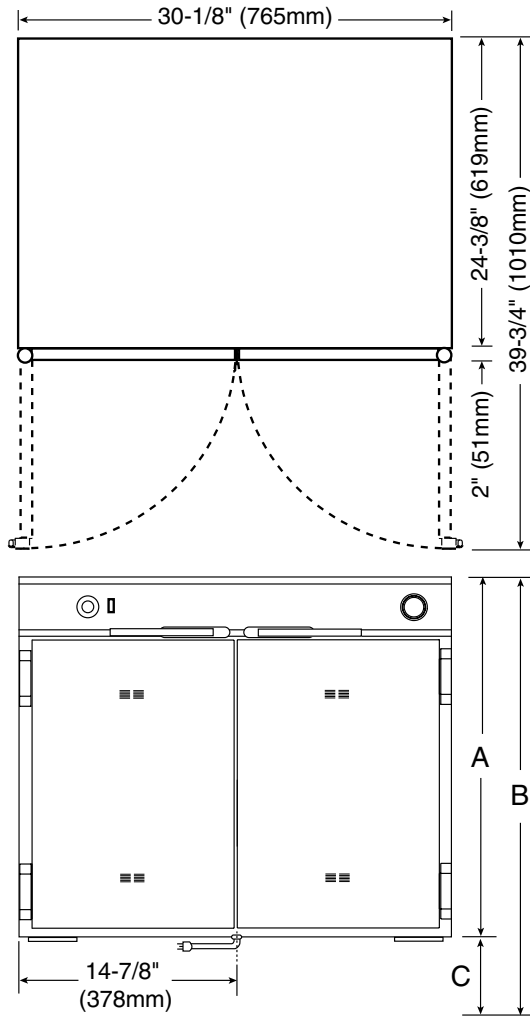

Electrical Connection on bottom,
1-5/8" (41mm) from back

Product/Pan Capacity	
48 lb (22 kg) maximum volume maximum: 51 qts. (57 liters)	
Full-size sheet pans: Six (6) 18" x 26" x 1" (457mm x 660mm x 25mm)	
Half-size sheet pans: *Twelve (12) 18" x 13" x 1" (457mm x 330mm x 25mm) *with additional shelves	
Full-size pans: *Six (6) 12" x 20" x 2-1/2" (530 x 325 x 65 mm) GN 1/1 *with additional shelves	
— Includes two (2) side racks spaced at 3" (76mm) centers	

Weight	
Net: 141 lb (64 kg)	Ship: 190 lb (86 kg)
Carton dimensions: L x W x H	
35" x 35" x 41" (889mm x 889mm x 1041mm)	

Accessories	
Casters, 3" (76mm), set of four (4)	14227
Casters, 5" (127mm), set of four (4)	4007
Legs, 6" (152mm), set of four (4)	5205
Pan Grid, stainless steel, wire	PN-2115
Shelf, chrome plated, wire	SH-2851

	A	B	C
Casters, 1-7/16" (35mm) (factory installed)	27-3/4" (705mm)	30" (762mm) approx.	2-1/16" (52mm)
Casters, 3" (76mm)	27-3/4" (705mm)	32" (813mm)	4-1/4" (108mm)
Casters, 5" (127mm)	27-3/4" (705mm)	34" (864mm)	6-1/4" (159mm)
Legs, 6" (152mm)	27-3/4" (705mm)	34" (864mm)	6-1/4" (159mm)

* Not available on 230V units; not interchangeable with other casters or legs.

NOTE: In order to maintain standards established by the National Sanitation Foundation, 6" (152mm) legs are required for countertop installation.

Electrical Connections

1. An identification tag is permanently mounted on the cabinet.
2. Plug cabinet into a properly grounded receptacle ONLY, positioning the unit so the power supply cord is easily accessible in case of an emergency.
Arcing will occur when connecting or disconnecting the unit unless all controls are in the "OFF" position.
3. If necessary, a proper receptacle or outlet configuration as required for this unit, must be installed by a licensed electrician in accordance with applicable, local electrical codes.

NOTICE: CE approved appliance must be connected to an electrical circuit that is protected by an external GFCI outlet.

Hard wired models:

Hard wired models must be equipped with a country certified external allpole disconnection switch with sufficient contact separation.

If a power cord is used for the connection of the product an oil resistant cord like H05RN or H07RN or equivalent must be used.

⚠ CAUTION



Power source must match voltage identified on appliance rating tag. The rating tag provides essential technical information required for any appliance installation, maintenance or repairs. Do not remove, damage or modify the rating tag.

⚠ WARNING







To prevent serious injury, death, or property damage:
All electrical connections must be made by a qualified and trained service technician in accordance with applicable electrical codes.



This appliance must be adequately grounded in accordance with local electrical codes or, in the absence of local codes, with the current edition of the National Electrical Code ANSI/NFPA No. 70. In Canada, all electrical connections are to be made in accordance with CSA C22.1, Canadian Electrical Code Part 1 or local codes.



CE-approved appliances include an equipotential-bonding terminal marked with the symbol shown on the left. Provisions for earthing are to be made in accordance with IEC:2010 60335-1 section 27 or local codes.

Electrical						
V	PH	Hz	A	kW		
120	1	50/60	18.8	2.25		NEMA L5-30P 30A, 125V PLUG
208	1	50/60	8.5	1.77		NEMA 6-15P 15A, 250V PLUG
240	1	50/60	9.8	2.25		
230	1	50	9.4	2.17	PLUGS RATED 250V	
 CEE 7/7		 BS 1363		 AS/NZS 3112		

Wire diagrams are located inside the top of the unit.

Operating Instructions

1. Turn thermostat to 200°F (93°C) and preheat for 30 minutes.

When the thermostat is turned clockwise to an ON position, the indicator light will illuminate and will remain lit as long as the unit is calling for heat. Close the ventilation openings inside the door to accelerate heating.

The indicator light will go OUT when the air temperature inside the unit reaches the temperature set by the operator. It will then cycle ON/OFF at this holding point. Verify the full preheated temperature with the holding temperature gauge located on the control panel of the cabinet.

2. Load the cabinet with hot food only.

The purpose of the holding cabinet is to maintain hot food at proper serving temperature. Before loading the cabinet with food, use a food thermometer to make certain all products are at an internal temperature range of 140° to 160°F (60° to 71°C). Any food product not within the proper temperature range should be heated before loading into the holding cabinet.

3. Reset the thermostat to 160°F (71°C).

Check to make certain the cabinet door is securely closed, and reset the thermostat to 160°F (71°C). **This will not necessarily be the final setting.** The proper temperature range for the products being held will depend on the type and quantity of product. When holding food for prolonged periods, it is advisable to periodically check the internal temperature of each item with a food thermometer to assure maintenance of the proper temperature range of 140° to 160°F (60° to 71°C).

General Holding Guidelines

Chefs, cooks and other specialized food service personnel employ varied methods of cooking. Proper holding temperatures for a specific food product must be based on the moisture content of the product, product density, volume, and proper serving temperatures. Safe holding temperatures must also be correlated with palatability in determining the length of holding time for a specific product.

Halo Heat maintains the maximum amount of product moisture content without the addition of water, water vapor, or steam. Maintaining maximum natural product moisture preserves the natural flavor of the product and provides a more genuine taste. In addition to product moisture retention, the gentle properties of Halo Heat maintain a consistent temperature throughout the cabinet without the necessity of a heat distribution fan, thereby preventing further moisture loss due to evaporation or dehydration.

When product is removed from a high temperature cooking environment for immediate transfer into equipment with the lower temperature required for hot food holding, condensation can form on the outside of the product and on the inside of plastic containers used in self-service applications. Allowing the product to release the initial steam and heat produced by high temperature cooking can alleviate this condition. To preserve the safety and quality of freshly cooked foods however, a maximum of 1 to 2 minutes must be the only time period allowed for the initial heat to be released from the product.

This unit is equipped with a thermostat control between 60° and 200°F (16° and 93°C). If the unit is equipped with vents, close the vents for moist holding and open the vents for crisp holding. Use a metal-stemmed thermometer to measure the internal temperature of the product being held. Adjust the thermostat setting to achieve the best overall setting based on internal product temperature.

Holding Temperature Range		
Meat	Fahrenheit	Celsius
Beef Roast — Rare	130°F	54°C
Beef Roast — Med/Well Done	155°F	68°C
Beef Brisket	160°F-175°F	71°C-79°C
Corn Beef	160°F-175°F	71°C-79°C
Pastrami	160°F-175°F	71°C-79°C
Prime Rib — Rare	130°F	54°C
Steaks — Broiled/Fried	140°F-160°F	60°C-71°C
Ribs — Beef Or Pork	160°F	71°C
Veal	160°F-175°F	71°C-79°C
Ham	160°F-175°F	71°C-79°C
Pork	160°F-175°F	71°C-79°C
Lamb	160°F-175°F	71°C-79°C
Poultry		
Chicken — Fried/Baked	160°F-175°F	71°C-79°C
Duck	160°F-175°F	71°C-79°C
Turkey	160°F-175°F	71°C-79°C
General	160°F-175°F	71°C-79°C
Fish/Seafood		
Fish — Baked/Fried	160°F-175°F	71°C-79°C
Lobster	160°F-175°F	71°C-79°C
Shrimp — Fried	160°F-175°F	71°C-79°C
Baked Goods		
Breads/Rolls	120°F-140°F	49°C-60°C
Miscellaneous		
Casseroles	160°F-175°F	71°C-79°C
Dough — Proofing	80°F-100°F	27°C-38°C
Eggs — Fried	150°F-160°F	66°C-71°C
Frozen Entrees	160°F-175°F	71°C-79°C
Hors d'oeuvres	160°F-180°F	71°C-82°C
Pasta	160°F-180°F	71°C-82°C
Pizza	160°F-180°F	71°C-82°C
Potatoes	180°F	82°C
Plated Meals	140°F-165°F	60°C-74°C
Sauces	140°F-200°F	60°C-93°C
Soup	140°F-200°F	60°C-93°C
Vegetables	160°F-175°F	71°C-79°C
The holding temperatures listed are suggested guidelines only. All food holding should be based on internal product temperatures. Always follow local health (hygiene) regulations for all internal temperature requirements.		

Food Safety

Food flavor and aroma are usually so closely related that it is difficult, if not impossible, to separate them. There is also an important, inseparable relationship between cleanliness and food flavor. Cleanliness, operating efficiency, and appearance of equipment contribute considerably to savory, appetizing foods.

Most food imparts its own particular aroma and many foods also absorb existing odors. Unfortunately, during this absorption there is not a distinction between **good** and **bad** odors. The majority of objectionable flavors and odors troubling food service operations are caused by bacteria growth. Sourness, rancidity, mustiness, stale or other undesirable flavors are usually the result of germ activity.

The easiest way to ensure full, natural food flavor is through comprehensive cleanliness. This means good control of both visible soil (dirt) and invisible soil (germs). A thorough approach to sanitation will provide essential cleanliness. It will ensure an attractive appearance of equipment, along with maximum efficiency and utility. More importantly, a good sanitation program provides one of the key elements in the prevention of food-borne illnesses.

A comprehensive sanitation program should focus on the training of staff in basic sanitation procedures. This includes personal hygiene, proper handling of raw foods, cooking to a safe internal product temperature, and the routine monitoring of internal food temperatures from the time the food is received through the time the food is served.

A controlled holding environment for prepared foods is just one of the important factors involved in the prevention of food-borne illnesses. Temperature monitoring and control during receiving, storage, preparation, and the service of foods are of equal importance.

The most accurate method of measuring safe temperatures of both hot and cold foods is by internal product temperature. A thermometer is an effective tool for this purpose, and should be routinely used on all products that require holding at a specific temperature.

Internal Food Product Temperatures		
Hot Foods		
Danger Zone	40°F to 140°F	4°C to 60°C
Critical Zone	70°F to 120°F	21°C to 49°C
Safe Zone	140°F to 165°F	60°C to 74°C
Cold Foods		
Danger Zone	Above 40°F	Above 4°C
Safe Zone	36°F to 40°F	2°C to 4°C
Frozen Foods		
Danger Zone	Above 32°F	Above 0°C
Critical Zone	0°F to 32°F	-18°C to 0°C
Safe Zone	0°F or Below	-18°C or Below

Hazard Analysis (at) Critical Control Points (HACCP), is a quality control program of operating procedures to assure food integrity, quality, and safety. Taking steps necessary to augment food safety practices is both cost effective and relatively simple. Additional HACCP information is available by contacting:

Center for Food Safety and Applied Nutrition
 Food and Drug Administration
 Phone: 1-888-SAFEFOOD
www.foodsafety.gov

Protecting Stainless Steel Surfaces



It is important to guard against corrosion in the care of stainless steel surfaces. Harsh, corrosive, or inappropriate chemicals can completely destroy the protective surface layer of stainless steel. Abrasive pads, steel wool, or metal implements will abrade surfaces causing damage to this protective coating and will eventually result in areas of corrosion. Even water, particularly hard water that contains high to moderate concentrations of chloride, will cause oxidation and pitting that result in rust and corrosion. In addition, many acidic foods spilled and left to remain on metal surfaces are contributing factors that will corrode surfaces.

Proper cleaning agents, materials, and methods are vital to maintaining the appearance and life of this appliance. Spilled foods should be removed and the area wiped as soon as possible but at the very least, a minimum of once per day. Always thoroughly rinse surfaces after using a cleaning agent and wipe standing water as quickly as possible after rinsing.

Cleaning Agents

Use non-abrasive cleaning products designed for use on stainless steel surfaces. Cleaning agents must be chloride-free compounds and must not contain quaternary salts. Never use hydrochloric acid (muriatic acid) on stainless steel surfaces. Failure to observe this precaution will void the warranty. Always use the proper cleaning agent at the manufacturer's recommended strength. Contact your local cleaning supplier for product recommendations.

Cleaning Materials

Cleaning can usually be accomplished with the proper cleaning agent and a soft, clean cloth. When more aggressive methods are needed, use a non-abrasive scouring pad on difficult areas and make certain to scrub with the visible grain of surface metal to avoid surface scratches. Never use wire brushes, metal scouring pads, or scrapers to remove food residue. Failure to observe this precaution will void the warranty.

NOTICE



To protect stainless steel surfaces, completely avoid the use of abrasive cleaning compounds, chloride based cleaners, or cleaners containing quaternary salts. **Never** use hydrochloric acid (muriatic acid) on stainless steel. **Never** use wire brushes, metal scouring pads or scrapers.

! WARNING



To prevent **serious personal injury, death, or property damage:**

The appliance must be cleaned thoroughly to avoid deposits of grease and or food residue inside the appliance that may catch fire. If fat deposits and/or food waste inside the appliance ignite, shut down the appliance immediately and keep the appliance door closed to extinguish the fire. If further extinguishing is required, disconnect the appliance from the main power and use a fire extinguisher (do not use water to extinguish a grease fire!). Failure to clean the appliance properly invalidates the warranty and relieves Alto-Shaam of all liability.

Cleaning and Preventative Maintenance

WARNING



To prevent serious personal injury, death, or property damage:

Do not steam clean, hose down or flood the interior or exterior with water or liquid solution of any kind. **Do not** use water jet to clean. Failure to observe this precaution will void the warranty.

WARNING



To prevent serious injury, death, or property damage, **always** disconnect the appliance from the power source before cleaning or servicing.

Clean the Holding Cabinet Daily:

1. Disconnect unit from power source and let cool.
2. Remove all detachable items such as wire shelves, side racks, drip trays, and drip pans. Clean these items separately.
3. Wipe the interior metal surfaces of the oven with a paper towel to remove loose food debris.
4. Clean the interior metal surfaces of the cabinet with a damp clean cloth or sponge and any good commercial detergent.

Notice: Never use abrasive cleaning compounds, chloride-based cleaners, or cleaners containing quaternary salts. Never use hydrochloric acid (muriatic acid) on stainless steel.

5. Spray heavily soiled areas with a water soluble degreaser and let stand for 10 minutes, then remove soil with a plastic scouring pad.
6. Wipe control panel, door vents, door handles, and door gaskets thoroughly since these areas harbor food debris.
7. Rinse surfaces by wiping with sponge and clean warm water.
8. Remove excess water with sponge and wipe dry with a clean cloth or air dry. Leave doors open until interior is completely dry. Replace side racks, drip trays, and shelves.

9. Wipe door gaskets and control panel dry with a clean, soft cloth.
10. Interior can be wiped with a sanitizing solution after cleaning and rinsing. This solution must be approved for use on stainless steel food contact surfaces.
11. To help maintain the protective film coating on polished stainless steel, clean the exterior of the cabinet with a cleaner recommended for stainless steel surfaces. Spray the cleaning agent on a clean cloth and wipe with the grain of the stainless steel.
12. Clean any glass with a window cleaner.

Always follow appropriate state or local health (hygiene) regulations regarding all applicable cleaning and sanitation requirements for equipment.

Thermostat and Indicator Light

Whenever the thermostat is turned “ON,” the indicator light will indicate the power ON/OFF condition of the heating cable, and consequently, the cycling of the cabinet as it maintains the dialed cavity temperature. If this light does not illuminate after normal start-up, the main power source, thermostat, and/or indicator light must be checked.

If the warming cabinet does not hold the temperature as dialed, the calibration of the thermostat must be checked. If the warming cabinet fails to heat or heats continuously with the thermostat “OFF,” the thermostat must be initially checked for proper operation. If these items are checked and found to be in order, a continuity and resistance check of the heating cable should be made. SEE CIRCUIT DIAGRAM.



This section is provided for the assistance of qualified and trained service technicians only and is not intended for use by untrained or unauthorized service personnel. Failure to observe this precaution may void the warranty.

Thermostat Calibration

The thermostat is precision calibrated at the factory. Normally, no adjustment or recalibration is necessary unless the thermostat has been mishandled in transit, changed or abused while in service. A thermostat with a sensing bulb operates on hydraulic pressure, consequently, any bending of the bulb results in a change in its volume, and alters the accuracy of the thermostat calibration.

A thermostat should be checked or recalibrated by placing a quality, thermal indicator at the center of an empty holding cavity. **Do not calibrate with any food product in the cabinet.** The thermostat should be set, and should be allowed to stabilize at that setting for a minimum of one hour. The center of the thermal swing of the air temperature within the cabinet should approximately coincide with the thermostat setting.

If calibration is necessary, the calibration screw should be adjusted with great care. The calibration screw of the thermostat is located in the thermostat dial shaft. With the shaft held stationary, a minute, clockwise motion of the calibration screw appreciably lowers the thermostat setting. A reverse, or counter-clockwise motion appreciably raises the thermostat setting. After achieving the desired cycling of the thermostat, the calibration screw must be sealed. Place a few drops of enamel sealant directly on the calibration screw.

(Red nail polish or equivalent is acceptable.)



Cable Heating Service Kit No. 4881					
Kit includes:			BU-3106	Cup Bushing	12
CB-3045	Cable Heating Element	210 feet	ST-2439	Stud	12
CR-3226	Ring Connector	12	NU-2215	Hex Nut	24
IN-3488	Insulation Corner	1 foot	SL-3063	Insulating Sleeve	12
BU-3105	Shoulder Bushing	12	TA-3540	Electrical Tape	1 roll

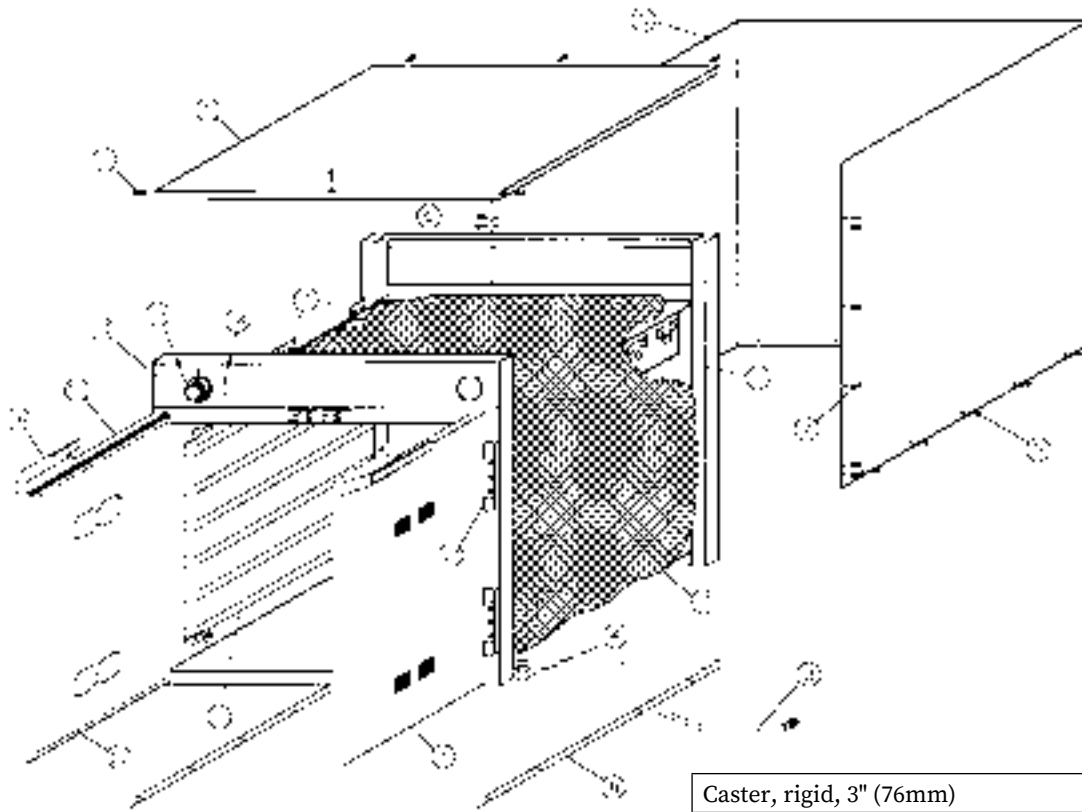

Caster, rigid, 3" (76mm)	CS-23731
Caster, swivel with brake, 3" (76mm)	CS-23730
Caster, rigid, 5" (127mm)	CS-2025
Caster, swivel with brake, 5" (127mm)	CS-2026
Caster, swivel, 1-7/16" (35mm)	CS-38989
Leg, 6" (152mm)	LG-2045

Item	Description	Part No.	Qty	Item	Description	Part No.	Qty
1	Top Assembly	4445	1	12	Heating Cable, 144' (43891mm)	CB-3045	1
2	Top Assembly Mounting Screws	SC-2425	6	13	Thermostat	TT-3057	1
3	Cordset, 120V, NEMA L5-30P	CD-33366	1		Thermostat Knob	KN-3469	1
	Cordset, 208-240V, NEMA 6-15P	CD-3551	1	14	Indicator Light (120V)	LI-3493	1
	Cordset, 230V, CEE 7/7	CD-3922	1		Indicator Light (208-240V, 230V)	LI-3516	1
	Cordset, 230V, AS/NZS 3112	CD-38149	1	15	Door Assembly, Right-Hand	5978	1
4	Bushing, Cord Strain Relief	BU-3964	1	16	Door Assembly, Left-Hand	5977	1
*	Bushing, Cord Strain Relief, 90° **	CR-39323	1	17	Hinge Set (1 pair of 2 hinges)	HG-2015	2
5	Casing	1009	1		Hinge Mounting Screws	SC-2072	24
6	Casing Mounting Screws	SC-2425	2	18	Door Handle	HD-2007	2
7	Casing Mounting Rivets	RI-2100	10		Door Handle Mtg. Screws	SC-2073	6
8	Bottom Assembly	4499	1		Door Handle Catch Mtg. Screws	SC-2071	6
	Bottom Assembly **	5023751	1	19	Door Gasket – Length Per Door: 7'	GS-2398	2
9	Bottom Assembly Mtg. Rivets	RI-2100	15	20	Side Rack	SR-2848	2
10	Insulation	IN-22364	1	21	Control Panel Overlay	PE-2703	1
11	Cable Connection Hardware	N/A	1	22*	Temperature Gauge	GU-3273	1

*NOT SHOWN **ON MODELS WITH FACTORY INSTALLED 1-7/16" (35mm) CASTERS ONLY

Part numbers and drawings are subject to change without notice.

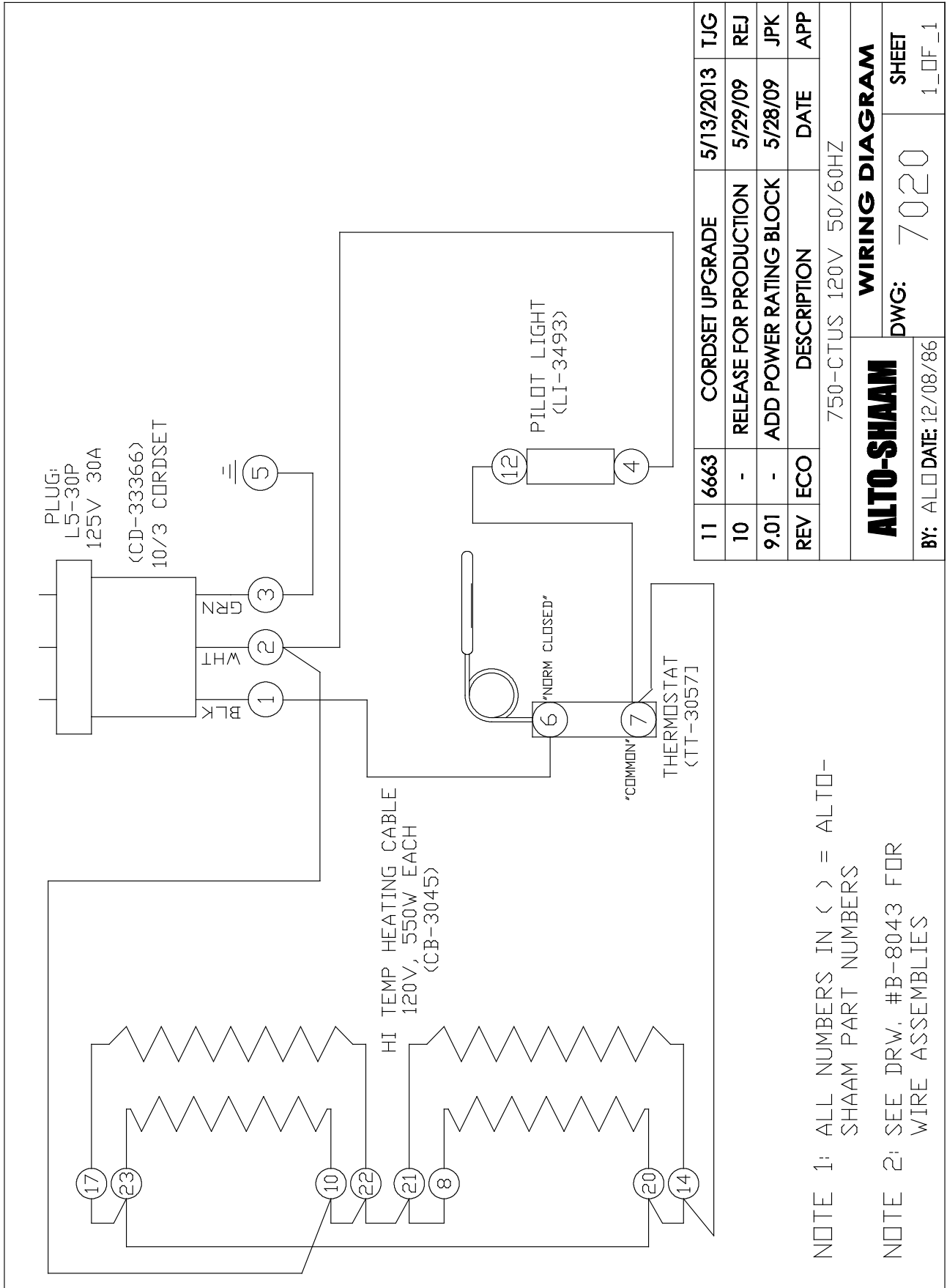

11	6663	CORDSET UPGRADE	5/13/2013	TJG
10	-	RELEASE FOR PRODUCTION	5/29/09	REJ
9.01	-	ADD POWER RATING BLOCK	5/28/09	JPK
REV	ECO	DESCRIPTION	DATE	APP
750-CTUS 120V 50/60HZ				
ALTO-SHAAM			WIRING DIAGRAM	
BY: ALD		DATE: 12/08/86	DWG: 7020	SHEET 1_OF_1

NOTE 1: ALL NUMBERS IN () = ALTO-SHAAM PART NUMBERS

NOTE 2: SEE DRW. #B-8043 FOR WIRE ASSEMBLIES

Wiring Diagrams

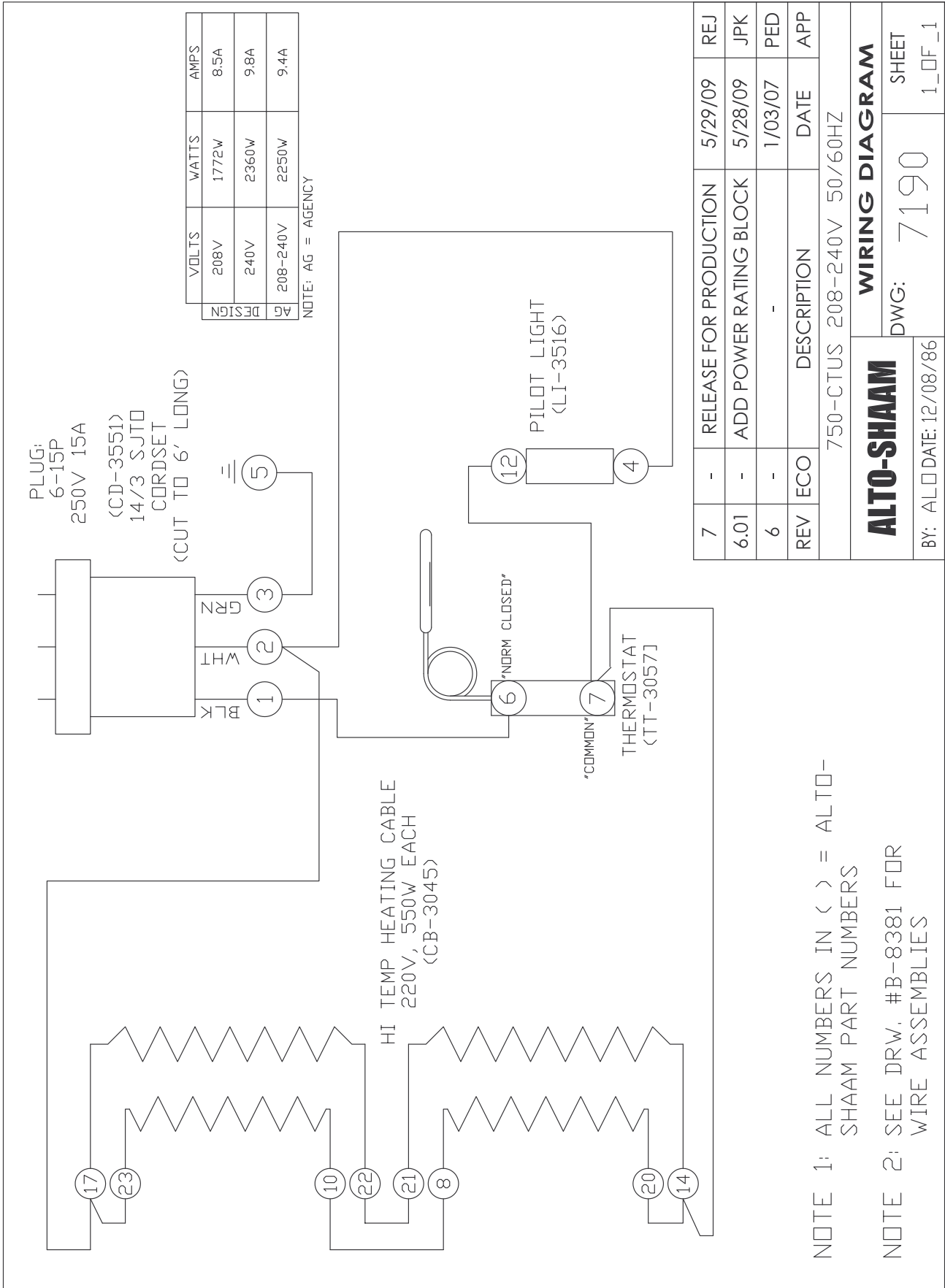

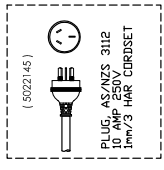
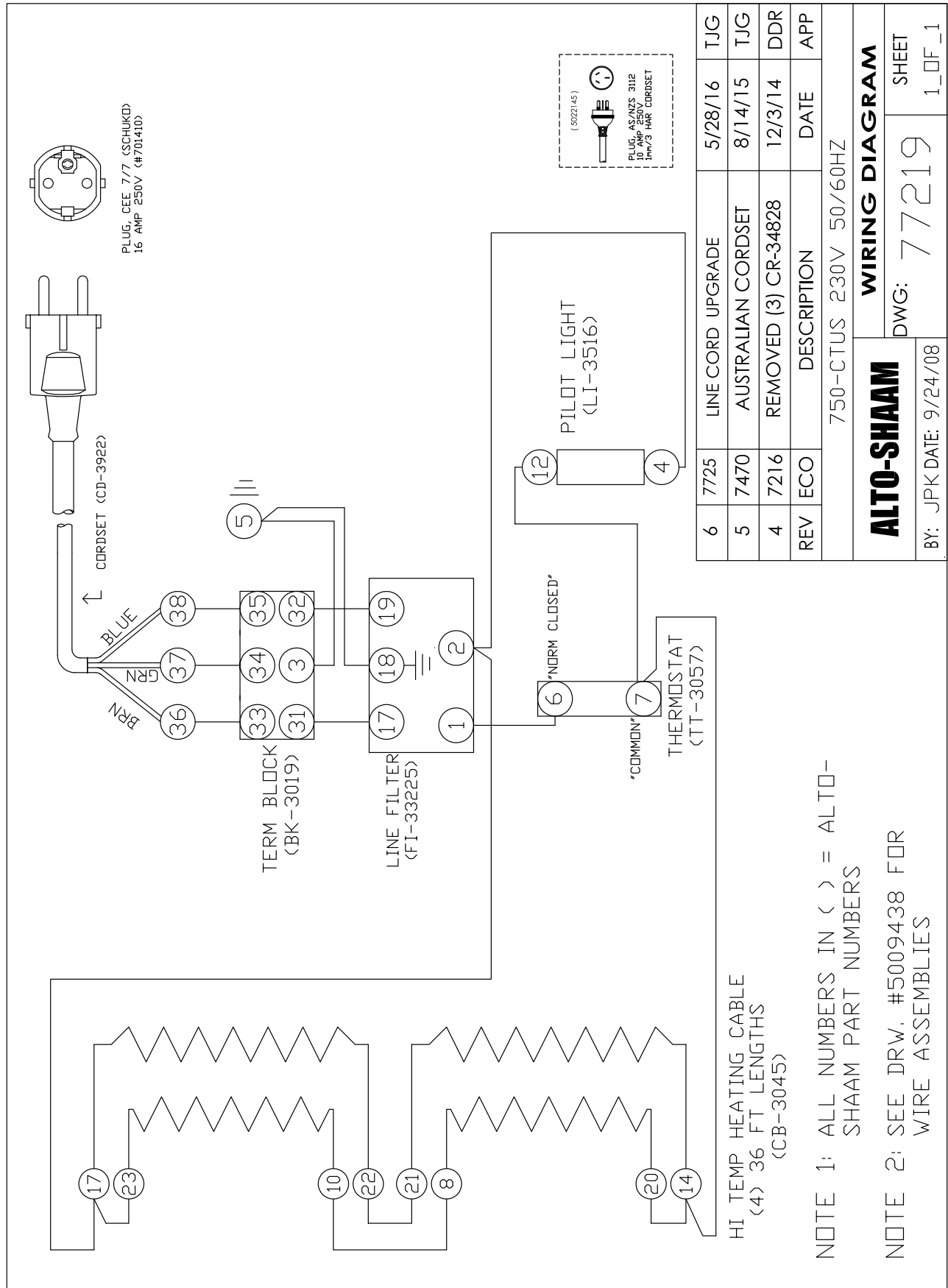

6	7725	LINE CORD UPGRADE	5/28/16	TJG
5	7470	AUSTRALIAN CORDSET	8/14/15	TJG
4	7216	REMOVED (3) CR-34828	12/3/14	DDR
REV	ECO	DESCRIPTION	DATE	APP
750-CTUS 230V 50/60HZ				
ALTO-SHAAM				
WIRING DIAGRAM				
BY: JPK DATE: 9/24/08			DWG: 77219	
			SHEET 1_OF_1	

Limited Warranty

Alto-Shaam, Inc. warrants to the original purchaser only that any original part that is found to be defective in material or workmanship will, at Alto-Shaam's option, subject to provisions hereinafter stated, be replaced with a new or rebuilt part.

The original parts warranty period is as follows:

For the refrigeration compressor on Alto-Shaam Quickchillers™, five (5) years from the date of installation of appliance.

For the heating element on Halo Heat® cooking and holding ovens, as long as the original purchaser owns the oven. This excludes holding only equipment.

For all other original parts, one (1) year from the date of installation of appliance or fifteen (15) months from the shipping date, whichever occurs first.

The labor warranty period is one (1) year from the date of installation or fifteen (15) months from the shipping date, whichever occurs first.

Alto-Shaam will bear normal labor charges performed during standard business hours, excluding overtime, holiday rates or any additional fees.

To be valid, a warranty claim must be asserted during the applicable warranty period. This warranty is not transferable.

This warranty does not apply to:

1. Calibration.
2. Replacement of light bulbs, door gaskets, and/or the replacement of glass due to damage of any kind.
3. Equipment damage caused by accident, shipping, improper installation or alteration.
4. Equipment used under conditions of abuse, misuse, carelessness or abnormal conditions, including but not limited to, equipment subjected to harsh or inappropriate chemicals, including but not limited to, compounds containing chloride or quaternary salts, poor water quality, or equipment with missing or altered serial numbers.
5. Damage incurred as a direct result of poor water quality, inadequate maintenance of steam generators and/or surfaces affected by water quality. Water quality and required maintenance of steam generating equipment is the responsibility of the owner/operator.
6. Damage caused by use of any cleaning agent other than Alto-Shaam's Combitherm® Cleaner, including but not limited to damage due to chlorine or other harmful chemicals. **Use of Alto-Shaam's Combitherm® Cleaner on Combitherm® ovens is highly recommended.**
7. Any losses or damage resulting from malfunction, including loss of product, food product, revenue, or consequential or incidental damages of any kind.
8. Equipment modified in any manner from original model, substitution of parts other than factory authorized parts, removal of any parts including legs, or addition of any parts.

This warranty is exclusive and is in lieu of all other warranties, express or implied, including the implied warranties of merchantability and fitness for a particular purpose. In no event shall Alto-Shaam be liable for loss of use, loss of revenue or profit, or loss of product, or for any indirect, special, incidental, or consequential damages. No person except an officer of Alto-Shaam, Inc. is authorized to modify this warranty or to incur on behalf of Alto-Shaam any other obligation or liability in connection with Alto-Shaam equipment.

Effective November 1, 2012

W164 N9221 Water Street • P.O. Box 450
Menomonee Falls, Wisconsin 53052-0450 U.S.A.

PHONE: 262.251.3800 • 800.558.8744 U.S.A. / CANADA
FAX: 262.251.7067 • 800.329.8744 U.S.A. ONLY
www.alto-shaam.com

Printed in the U.S.A