



# User Manual

*Manual version:  
October 2020*



**Fantastic M/AS Advance  
Version 08 and newer**



**Fantastic M/SB Advance  
Version 08 and newer**



## Citrus America, Inc.

2781 Wrights Rd, Ste 1233, Oviedo, FL 32765

Phone: (407) 790-7862 / Fax: (407) 790-7863

Website: [www.citrusamerica.com](http://www.citrusamerica.com)

Training: [www.citrusamerica.com/training](http://www.citrusamerica.com/training)

**NOTICE:** ALL USERS OF THIS JUICER MUST UNDERSTAND THE **IMPORTANT SAFEGUARDS** SECTION AND THE CONTENTS OF THIS MANUAL. THIS INSTRUCTION MANUAL SHOULD BE LOCATED IN AN ACCESSIBLE LOCATION FOR ALL USERS OF THE JUICER.

## CONTENTS

|     |  |    |
|-----|--|----|
| 1.  | IMPORTANT GENERAL INFORMATION AND SAFEGUARDS | 2  |
| 2.  | CITROCASA LIMITED WARRANTY                   | 5  |
| 3.  | TECHNICAL SPECIFICATIONS                     | 6  |
| 4.  | PRESSING KITS AND FRUIT SIZES                | 7  |
| 5.  | MACHINE PART OVERVIEW                        | 8  |
| 6.  | SETTING UP YOUR CITROCASA JUICER             | 9  |
| 7.  | OPERATING YOUR CITROCASA JUICER              | 10 |
| 8.  | CLEANING YOUR CITROCASA JUICER               | 17 |
| 9.  | SPARE PARTS                                  | 24 |
| 10. | CERTIFICATIONS                               | 27 |



# 1. IMPORTANT GENERAL INFORMATION AND SAFEGUARDS



***Congratulations on the purchase of your Citrocasa juicer!*** This machine has been designed solely for the pressing of oranges and other citrus fruit that meet the required size specifications (see page 7) to obtain high-quality juice. Our slicing and pressing system has been designed to dramatically reduce the amount of peel oil and peel contamination in the juice; however, the fruit used must meet the **appropriate size specifications**, and the **cleaning and hygiene procedures** detailed in this manual must be followed.

This manual refers to the following Citrocasa models:

**Fantastic M/AS Advance (Version 08 and newer)**

**Fantastic M/SB Advance (Version 08 and newer)**

**Please read this manual carefully and in its entirety prior to operating or cleaning your juicer.**

## GENERAL INFORMATION:

- Citrocasa juicers are certified and in accordance with the **NSF, UL, CE, GS** and **TUV** safety standards.
- The technical data of the Citrocasa juicer is located on the ID plate on the rear of the machine. **When ordering spare parts, be sure to mention the model and serial number.** Only use spare parts and accessories from Citrocasa. Other spare parts may damage your machine.
- For all technical questions, please refer to your authorized dealer or customer service representative and mention the model and serial number of your machine. Only qualified technicians should open the back of the machine for servicing. Servicing by anyone other than qualified technicians can lead to injury and machine damage and will void your warranty.
- In case of damage to the machine or its failure to function properly, you should contact your authorized dealer/supplier or Citrus America, Inc.
- This machine is designed solely for the pressing of oranges and other citrus fruits meeting the specifications described in this manual. **DO NOT** attempt to process any other food items.

**The juice from this machine has not been pasteurized and must be packaged, labeled, marketed, and sold in compliance with the appropriate local, state, and federal rules and regulations.** Please familiarize yourself with local, state, and federal regulations related to selling fresh juice at your location.

## IMPORTANT SAFEGUARDS:

- All operators or users of this machine should be required to understand the **important safeguards** set forth below and read this instruction manual.
- Ensure that all users understand the content of the warning labels shown on the back or side of the machines.
- This machine has moving parts and a sharp blade. **DO NOT** operate this machine without the proper training and **DO NOT** operate this machine without the appropriate covers and parts securely in place.

### **Citrus America, Inc.**

2781 Wrights Rd, Ste 1233, Oviedo, FL 32765

Phone: (407) 790-7862 / Fax: (407) 790-7863

**Toll Free Number: 1-855-MY-CITRO (1-855-692-4876)**

Website: [www.citrusamerica.com](http://www.citrusamerica.com) Tech Support: [technical@citrusamerica.com](mailto:technical@citrusamerica.com) Training: [www.citrusamerica.com/training](http://www.citrusamerica.com/training)

## **IMPORTANT SAFEGUARDS (CONTINUED)**



- Please read the section on cleaning and hygiene and be sure that all personnel are adequately trained on machine usage **prior** to their using the equipment.
- Before cleaning the machine, making any repairs or maintenance, **FOR YOUR SAFETY** please ensure that the machine is unplugged from its power supply.
- Always **TURN OFF AND UNPLUG** the machine from the power outlet when not in use, before putting on or taking off parts and before cleaning. To unplug, grasp the plug and pull it from the electrical outlet. Never pull the cord.
- **FOR YOUR SAFETY, NO PROTECTION OR SAFETY EQUIPMENT IS TO BE CHANGED, REMOVED OR TAMPERED WITH.** For safety reasons and to prevent damage to the machine, only authorized and trained service technicians are allowed to service, make any repairs or changes on the machine, or to remove the back cover on the machine. **FAILURE TO FOLLOW THESE INSTRUCTIONS MAY LEAD TO SERIOUS INJURY, MACHINE DAMAGE and LOSS OF WARRANTY!**
- The on-off switch and power outlet should be readily accessible to users so that they can easily switch off the machine and unplug it.
  
- **WARNING:** The equipment is heavy. Do not attempt to lift the juicer on your own. Make sure to place it on a stable surface that can bear the weight and stabilize and secure it properly. The machine should be placed at an operating height that is ergonomic and does not require users to strain to reach the supply tunnel or any other parts of the machine that are intended to be accessible to users.
- This machine is not intended for use by persons under the age of 18 or by persons with certain disabilities or reduced physical, sensory or mental capabilities. This machine should not be used by persons lacking experience and knowledge with respect to the operation or maintenance of the machine, unless they are under the supervision of, and are being instructed by, a person having such experience and knowledge and who is responsible for their safety.
- Children must be supervised to ensure that they do not attempt to touch, operate or play with the machine.
- Do not operate this, or any other motor-driven equipment, while under the influence of alcohol or other substances that affect your reaction time or perception.
  
- **TO PROTECT AGAINST RISK OF ELECTRICAL SHOCK, DO NOT PUT THE BASE IN WATER OR OTHER LIQUID. CAUTION: IMMERSING, SPRAYING, OR HOSING THE POWER UNIT WILL VOID YOUR WARRANTY.** Do not immerse or spray the unit with water or other liquids. The base and machine housing should only be cleaned with a damp cloth or sponge. Never spray or hose down the base or machine housing. The motor and electrical parts of the machine are not waterproof. Contact with water or other liquids will damage the motor, bearings, and electrical system.
- **Exercise caution when handling the cutting blade during cleaning. THE BLADE IS RAZOR SHARP AND CAN CAUSE SERIOUS INJURY.**

## IMPORTANT SAFEGUARDS (CONTINUED)



- Do not use outdoors.
- Do not let the cord hang over the edge of table or counter or touch hot surfaces.
- Do not operate any machine with a damaged cord or plug, or after the machine has been dropped or damaged in any way. If this occurs, contact the nearest authorized service facility for examination, repair or electrical or mechanical adjustment. If the supply cord is damaged, it must be replaced by the manufacturer, its service agent or similarly qualified persons in order to avoid a hazard.
- Use a dedicated 20amp circuit. The electrical outlet should be grounded. If your outlet is not grounded, replace the outlet with a grounded outlet to prevent an electrical shock hazard. Do not modify the power cord by cutting off or removing the ground lead.
- DO NOT TOUCH MOVING PARTS.
- DO NOT PLACE FINGERS OR OTHER OBJECTS INTO THE JUICER OPENING WHILE IT IS PLUGGED IN OR IN OPERATION.
- NEVER REMOVE, DESTROY OR ALTER ANY WARNING LABELS OR PROTECTIVE OR SAFETY GUARDS.
- **DISPOSAL:** This product should not be disposed of with other household wastes. To prevent possible harm to the environment or human health from uncontrolled waste disposal, recycle it responsibly to promote the sustainable reuse of material resources. To return your used device, please use the return and collection systems or contact the dealer or supplier from whom the product was purchased. They can take this product for environmentally safe recycling.

*Citrocasa may make changes to this instruction manual without prior notice. The most current version of this manual may be obtained by contacting Citrus America, Inc. directly. If you have any suggestions to improve this manual or our products, or any questions regarding the training of users or machine operation and maintenance, or any other comments, please contact your dealer/supplier or Citrus America, Inc.*

**Detailed training videos can be found at: [www.citrusamerica.com/training](http://www.citrusamerica.com/training)**

***We hope you will enjoy many years of juicing with your Citrocasa juicer!***

### **Citrus America, Inc.**

2781 Wrights Rd, Ste 1233, Oviedo, FL 32765

Phone: (407) 790-7862 / Fax: (407) 790-7863

**Toll Free Number: 1-855-MY-CITRO (1-855-692-4876)**

Website: [www.citrusamerica.com](http://www.citrusamerica.com) Tech Support: [technical@citrusamerica.com](mailto:technical@citrusamerica.com) Training: [www.citrusamerica.com/training](http://www.citrusamerica.com/training)

## 2. CITROCASA LIMITED WARRANTY

The manufacturer of the Citrocasa juicer warrants, to the original purchaser only, against defects in parts or workmanship for a period of one year from the date of purchase. The manufacturer may, at its option, repair or replace any machine under warranty. This limited warranty is only valid for machines sold and used in North America.

This limited warranty does not cover damage or failure resulting from ordinary wear and tear, mishandling, abuse, misuse or improper use, or from operation or maintenance in a manner not in accordance with this instruction manual.

If the machine is required to be returned to the manufacturer or to Citrus America, Inc. for warranty repair or replacement, the purchaser will be required to pay any travel costs for onsite service (if offered by the purchaser's dealer/supplier) and any freight or transportation costs to return the machine to Citrus America, Inc.'s facilities in the United States. The manufacturer will not pay any freight or transportation cost to return the repaired machine or a replacement machine to the purchaser.

If you believe that your juicer requires a warranty repair or replacement, you should first contact your dealer/supplier. If your dealer/supplier verifies that your juicer will require repair or replacement, you should not ship or send the juicer to Citrus America, Inc. without first obtaining from Citrus America, Inc. a return authorization number and instructions for proper packing and return shipment. All risk of loss or damage from improper packing or shipment by purchaser will be borne by purchaser.

**THIS LIMITED WARRANTY WILL BE VOIDED BY ANY CHANGES TO THE IDENTIFICATION PLATE ON THE MACHINE, OR IF ANY THIRD PARTY, OTHER THAN AUTHORIZED AND QUALIFIED SERVICE PERSONNEL, REMOVE THE BACK OF THE MACHINE, OR MAKE ANY REPAIRS OR MODIFICATIONS TO THE MACHINE.**

If you contact your dealer/supplier or Citrus America, Inc. with respect to warranty or other service or repair, always mention the correct model and serial number of the machine.

Except with respect to the obligations assumed in the express limited warranty set forth above, under no circumstances will the manufacturer or Citrus America, Inc. be liable for any loss, damage, whether direct, indirect, incidental, special, consequential, or punitive, or for any costs or expenses incurred, arising out of or in connection with the use of the Citrocasa juicer. Manufacturer's and Citrus America, Inc.'s liability shall not exceed the purchase price paid. The warranty terms and remedies are in lieu of any and all other warranties, express or implied, including warranties of merchantability and warranties of fitness for a particular purpose. (Some states do not allow the limitation or exclusion of incidental or consequential damages, so the above limitation or exclusion may not apply to you.)

### 3. TECHNICAL SPECIFICATIONS

**Fantastic M/AS**

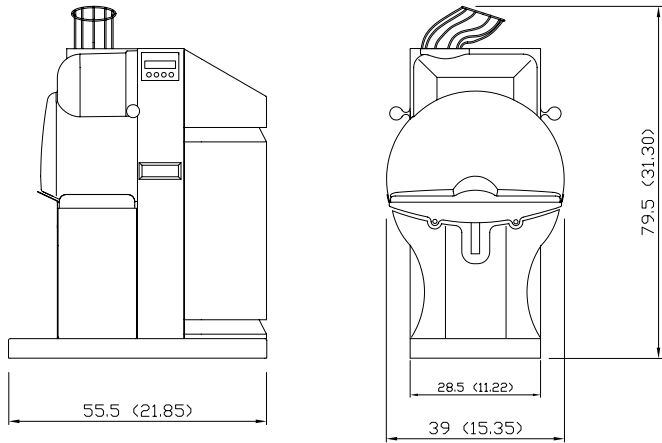

**Fantastic M/SB**

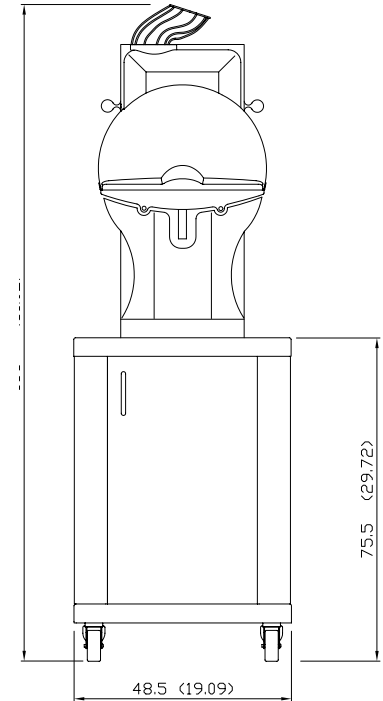
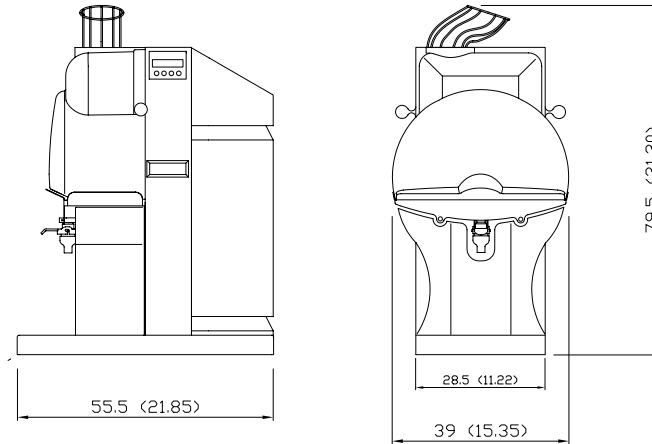

**Fantastic M on Cabinet**

Measurements in inches (cm)

| Model                | Fantastic M/AS / Fantastic M/SB  |
|----------------------|--|
| Fruit per Minute     | Approx. 30 pcs. of fruit   |
| Fruit Specifications | <b>Citrus</b> fruit, diameter (standard pressing kit): 2.55 - 3.14 in (65-80mm); <i>for details see page 7. Do not use frozen fruit! Only use juice fruit!</i> |
| Net Weight           | Juicer: 95.9 lb (43.5 kg)<br>Incl. cabinet: 159.8 lb (72.5 kg)   |
| Power Supply         | 120 V/60 Hz  |
| Power                | 0.28 kW  |
| Fuse                 | 6.3 A  |
| Fuse Protection      | IPx1   |

- **The machine is very heavy. Make sure to place the machine on a stable surface that can bear the weight!**
- **Do not attempt to lift it on your own.**
- **Use the handles on the side of the machine to lift it. Do not lift at the front cover!**
- **Stabilize the machine when lifting it.**
- **Keep the machine stabilized until it has been mounted to a cabinet or countertop.**

## 4. PRESSING KITS AND FRUIT SIZES FANTASTIC M

### STANDARD PRESSING KIT



**Fruit Size Diameter:** 2.55 - 3.14 in  
(65 - 80 mm)

**Typical Fruit Squeezed:**  
**Oranges** | Larger Lemons and Tangerines

### SMALL PRESSING KIT



**Fruit Size Diameter:** 1.96 - 2.55 in  
(50 - 65 mm)

**Typical Fruit Squeezed:**  
**Lemons** | **Limes** | **Tangerines** | Smaller Oranges



#### **PRESSING KIT OPERATIONAL TIPS:**

- **DO NOT** mix parts of different pressing kits. Mixing parts can damage your juicer!
- Use the **fruit sizing tool** provided for each pressing kit (for details see page 10). Using the wrong size fruit can degrade the juice, cause jams, and damage your juicer!
- Be sure to control the flow of fruit into the juicing area to avoid fruit jams:  
**Oblong fruit** with pointy ends (e.g. lemons), **flat fruit** (e.g. tangerines), or **large fruit** may need attention to manage flow.



## 5. MACHINE PART OVERVIEW\*

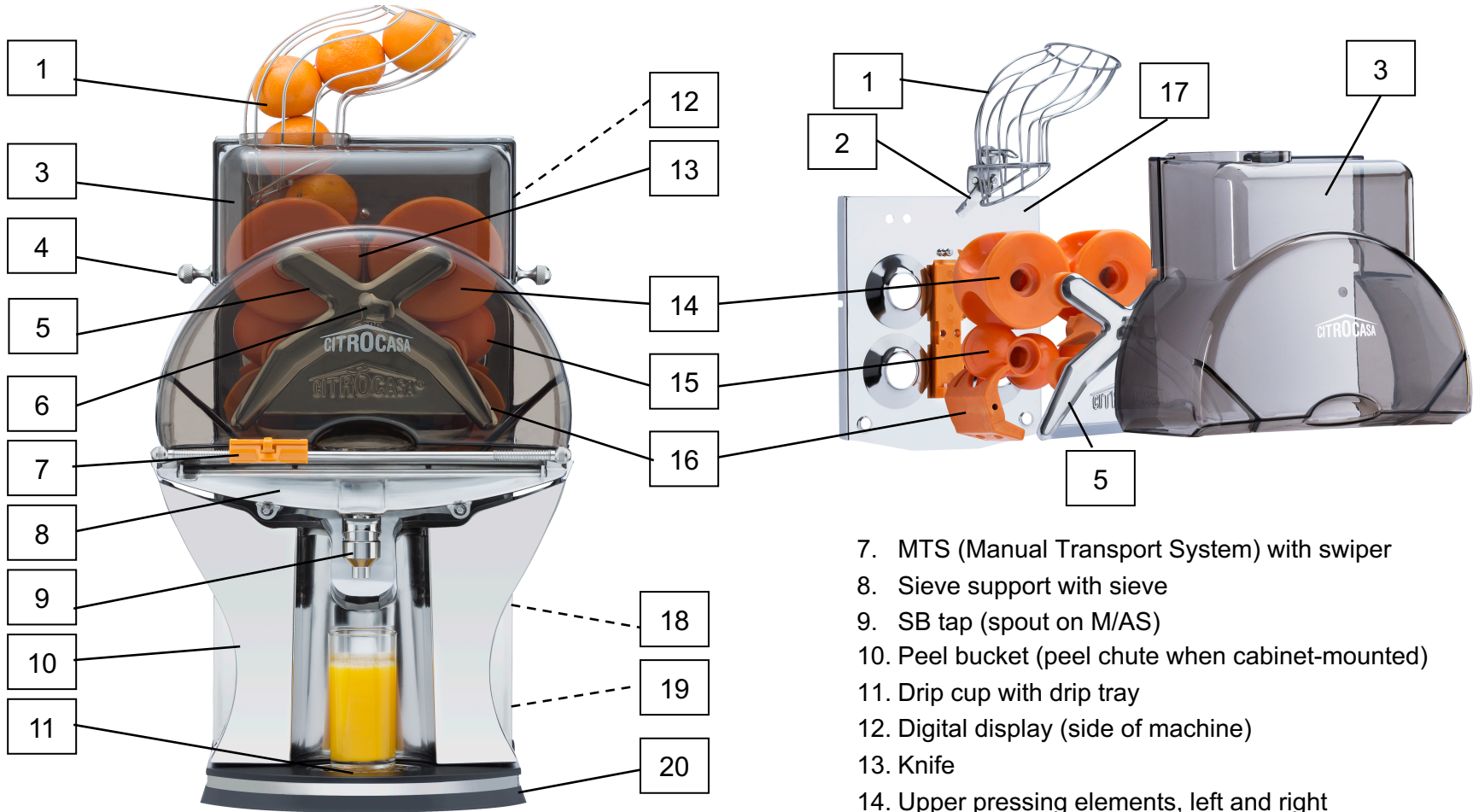

1. Fruit supply tunnel
2. Locking lever (for fruit supply tunnel)
3. Front cover
4. Front cover screws, left and right
5. Cross holder
6. Cross holder screw

7. MTS (Manual Transport System) with swiper
8. Sieve support with sieve
9. SB tap (spout on M/AS)
10. Peel bucket (peel chute when cabinet-mounted)
11. Drip cup with drip tray
12. Digital display (side of machine)
13. Knife
14. Upper pressing elements, left and right
15. Lower pressing elements, left and right
16. Peel ejectors, left and right
17. Double cover
18. Main power switch (side of machine)
19. ID plate (back of machine)
20. Adaptable base plate

\* **MODEL SHOWN: Fantastic M/SB Advance**

## 6. SETTING UP YOUR CITROCASA JUICER: FANTASTIC M/SB and FANTASTIC M/AS

For optimal and safe operation, please follow the below mentioned steps carefully.

- **Careful: The machine is heavy – do not attempt to unpack and lift on your own.**
- Place the machine on a **flat, level, and stable** surface. Ensure that the surface can bear the **weight of the machine** (see technical specifications).
- The Fantastic M has an adjustable base plate and can be operated either as a **tabletop unit** or with one of the following options:
  - **Citrocasa Cabinet:** Install your Fantastic M on the Citrocasa stainless steel Fantastic Cabinet (sold separately).
  - **Counter Installation Kit:** Install your Fantastic M on your own cabinet countertop using the Citrocasa Counter Installation Kit (sold separately). Please contact Citrus America for product details and mounting instructions.
- Take off the front cover by unscrewing the front cover screws on the left and the right, pulling the lower part of the front cover lightly toward the front and lifting the cover away from the retaining bolts (Pic 1).
- Mount the fruit supply tunnel and close the locking lever (Pic 2).
- Place the peel bucket and the drip cup as shown in Pics 3 and 4.
- Ensure that the MTS System is in its proper position (Pic 5).
- Ensure that the front cover is closed and mounted properly.
- Make sure that the electrical power is available as indicated on ID plate on the rear of the machine (Pic 6).



Pic 1

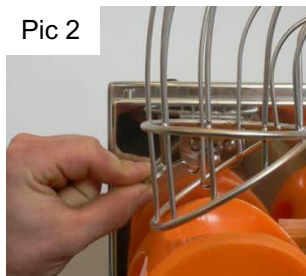

Pic 2

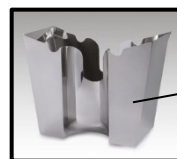

Pic 3

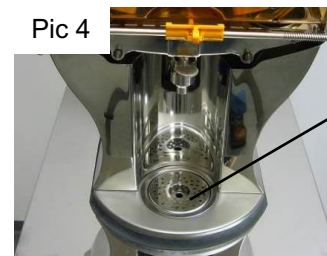

Pic 4

Drip cup

MTS system



Pic 5



Pic 6

ID plate



## 7. OPERATING YOUR CITROCASA JUICER: FANTASTIC M/SB and FANTASTIC M/AS

To begin juicing, follow these steps:

- Prior to juicing for the first time, clean all the parts that come into contact with the juice.
- Fill the fruit supply tunnel with fruit (Pic 1 and 2).
- Please refer to the Fruit Size Specifications on page 7 of this manual and use the sizing tool supplied (Pic 3). The fruit has to be the same size as or larger than the smaller end of the tool and it has to be the same size as or smaller than the wider end of the tool (Pic 4 and 5). **Using the wrong size fruit can degrade the juice quality and damage the equipment!**
- *Note: We provide different sizing tools for the Standard and Small Pressing Kits.*
- *Note: For added hygiene, we provide an optional washable Fruit Basket Dust Cover (Pic 6, sold separately)*



Pic 1



Pic 2



Pic 4



Pic 5

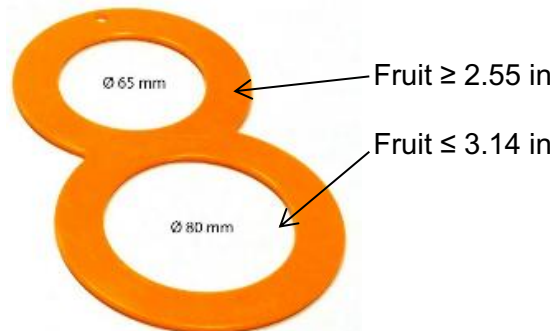

Pic 3



Pic 6

## SWITCH ON YOUR JUICER:

- Plug the machine into a standard grounded outlet. Turn on the main switch on the side of machine (Pic 7). The switch will light up.
- By pressing the **function button** (☰) you will be able to view several different menu options, which are explained over the next few pages (Pic 8).

## CHOOSE A DISPLAY LANGUAGE:

You can choose between five different display languages: English, German, Spanish, French, Italian. Follow the points below to select a language (Pic 9).

1. With the **function button** (No 1), select the menu item “Choose language”.
2. Move through the language options by pressing the **ON** (No 2) and the **OFF** button (No 3) **AT THE SAME TIME**. Stop on the desired language.
3. Press the **function button**. The display language is now saved.

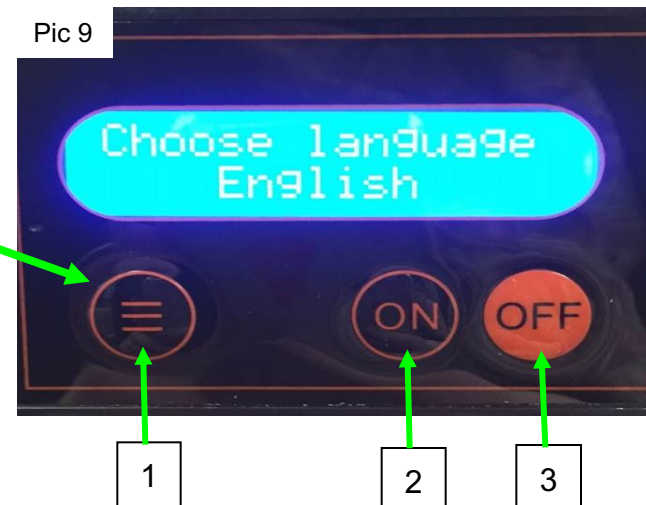
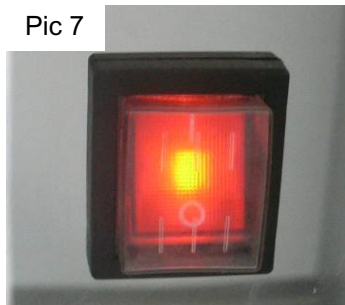

On the **Fantastic M/SB**, you can choose between two operating modes: **self-service** and **continuous** pressing.

- **SELF-SERVICE MODE (Pic 10):**

- With the **function button** select the **self-service** mode. You will see “Self service Push <Press>” on the display.
- When you press down the **SB tap** (self-service tap, Pic 12), the machine will automatically begin to press fruits. By releasing the SB tap, the machine will stop the pressing process.
- **Attention:** *By only pressing down the SB tap halfway, whatever juice is in the sieve support will flow out of the tap, but the machine will not press more fruit.*

- **CONTINUOUS MODE (Pic 11):**

- With the **function button** select **continuous** mode. You will see “Continuous Push <ON>” on the display.
- Press the **ON** button for the machine to begin pressing continuously.
- Press the **OFF** button for the machine to stop the pressing process.
- **Attention:** *If you do not release juice from the tap, the juice will collect in the sieve support and overflow. You have the option to remove the lower tap piece to allow the free flow of juice into a container.*
- **Attention:** *The machine will continue to operate, even if there is no more fruit left in the fruit supply tunnel. Press the OFF button to stop the machine.*

Display self-service mode

Pic 10



Display continuous mode

Pic 11

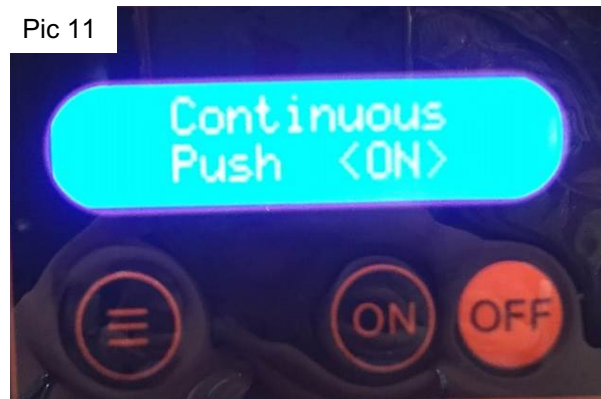

SB tap

Pic 12



## FANTASTIC M/AS: SELECT AN OPERATING MODE

On the **Fantastic M/AS**, you can choose between two operating modes: **auto-start** and **continuous** pressing.

**Attention:** The spout on the Fantastic M/AS is open! Please ensure to place a container under the spout before you start juicing.

- **AUTO-START MODE (Pic 13):**

- With the **function button** select the **auto-start** mode. You will see “Fill in oranges” on the display.
- Due to the **fruit detection sensor** at the fruit supply tunnel (Pic 14), the machine will start pressing automatically as soon as you fill fruit into the fruit supply tunnel.
- The machine will stop pressing when there is no more fruit left in the fruit supply tunnel. To keep pressing, continue to feed fruit into the tunnel.

- **CONTINUOUS MODE (Pic 15):**

- With the **function button** select the **continuous** mode. You will see “Continuous Push <ON>” on the display.
- Fill in fruit and press the ON/OFF button for the machine to start/stop juicing.
- **Attention:** The machine will continue to operate, even if there is no more fruit left in the fruit supply tunnel. Press the OFF button to stop the machine.

Display auto-start mode

Pic 13



Fruit detection sensor

Pic 14

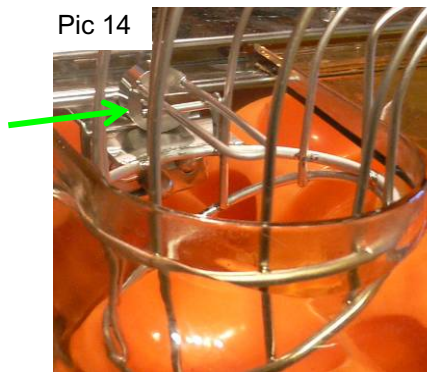

Display continuous mode

Pic 15

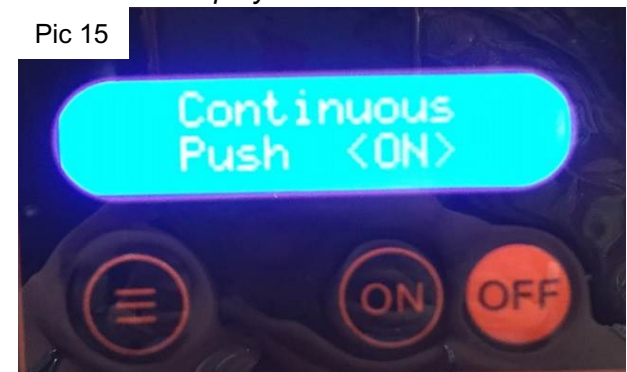



## FANTASTIC M/SB and FANTASTIC M/AS:

### USING THE MANUAL TRANSPORT SYSTEM (MTS):

1. Push down the metal lever on the left to raise the sieve.
2. Slide the MTS swiper across the sieve as needed to push seeds and pulp into the peel buckets/chutes (Pic 16).

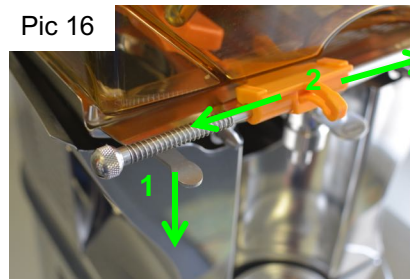

### INTELLIGENT STOP FUNCTION:

For improved peel management, it is possible to set the machine to automatically stop pressing after a certain amount of fruit has been pressed, reminding you to empty the peel bucket in order to avoid peel jams.

- With the **function button**, select the function “Empty bucket after xx oranges” (Pic 17).
  - Adjust the amount of oranges to be pressed by pushing the **ON (increase +)** or the **OFF button (decrease -)**. See table below for recommended adjustments. **Note:** *Different size fruit may require different maximum settings.*
  - Use the **function button** to select the desired pressing mode. Start the machine in the desired mode.
  - When the preset amount of oranges has been pressed, the machine will stop and beep 5 times. It will automatically lock.
  - Empty the peel bucket. Load fresh fruit as required.
  - To unlock the machine and continue juicing, press and hold the **OFF** button for 5 seconds. The machine is now ready for juicing again.
- **Attention:** *If you want to switch off the Intelligent Stop function, simply adjust to 00 oranges.*

Pic 17



| Peel Bucket  | Recommended Adjustment |
|--|------------------------|
| Peel bucket tabletop   | 16-20 fruit            |
| Cabinet-mounted or countertop installation kit with large peel container | 120 oranges            |

## LOCK/UNLOCK DISPLAY:

It is possible to lock the display in the preset pressing mode to avoid unintentional setting changes.

### To lock the display:

- Select the desired pressing mode.
- Press the **function button** and the **OFF** button *at the same time* (Pic 18).
- The display is now locked, and the selected pressing mode cannot be changed unintentionally. If you press the function button, you will see how to unlock the display.

### To unlock the display:

- Press the **function button** and the **OFF** button *at the same time* (Pic 19).

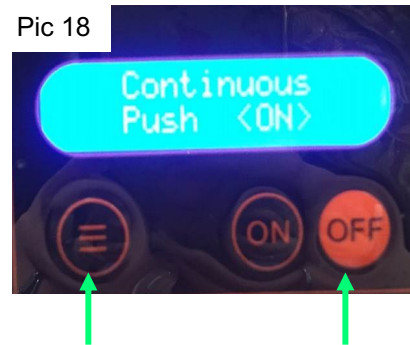

## TOTAL AMOUNT OF SQUEEZED FRUITS:

- Press the function button to see the total amount of fruits pressed up to the current moment (Pic 20).

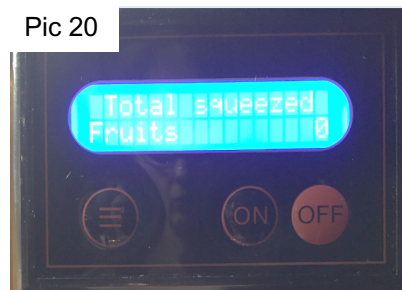

## TOTAL AMOUNT OF OPERATING HOURS:

- Press the function button to see the total amount of operating hours up to the current moment (Pic 21).



## FACTORY MODE: **ONLY FOR TECHNICIANS!**

- This function is locked by password and can only be used by technicians (Pic 22).

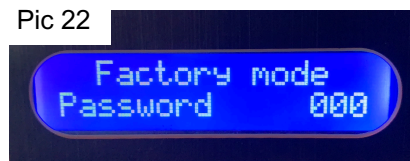

## SHUTTING DOWN YOUR CITROCASA FANTASTIC:

- The **lower pressing elements** on the Fantastic Advance are designed to return to a **preprogrammed end position** when properly operated and shutdown. In the correct end position (Pic 2), the blade and lower pressing elements **can easily be removed for cleaning and re-assembled**.
- Stop juicing by pressing the OFF button on the display (Fantastic M/AS and SB) or releasing the self-service tap (Fantastic M/SB). The Fantastic M/AS will also automatically stop juicing, once all the fruit in the supply tunnel has been juiced. Turn off the main power switch and pull the plug **only after** the machine has stopped juicing and come to a standstill.
- Note: If the machine has been shut down improperly by accident, turn it on again, start the juicing operation, and perform a proper shutdown, as described above. This will return the lower pressing elements to their proper end position.

**CAUTION:** DO NOT SHUT THE MACHINE OFF WITH THE MAIN POWER SWITCH OR BY PULLING THE CORD WHILE IT IS STILL JUICING AND THE PRESSING ELEMENTS ARE STILL MOVING. SUCH IMPROPER SHUTDOWN MAY CAUSE THE PRESSING ELEMENTS TO STOP IN THE INCORRECT END POSITION (Pic 1). THE JUICER CAN NO LONGER BE RE-ASSEMBLED AFTER CLEANING.

**CAUTION:** IF THE MACHINE HAS BEEN DISASSEMBLED AFTER IMPROPER SHUTDOWN AND CAN THEREFORE NOT BE RE-ASSEMBLED, CALL THE SERVICE HOTLINE OR YOUR SERVICE REPRESENTATIVE. DO NOT FORCE THE PARTS INTO PLACE SINCE THIS CAN CAUSE SEVERE DAMAGE TO THE MACHINE.

### INCORRECT END POSITION

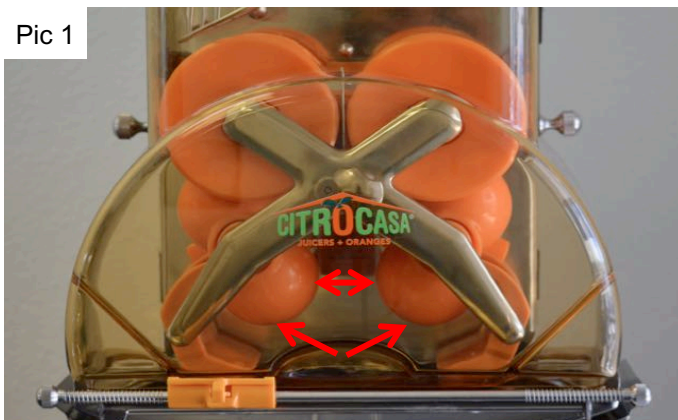

### CORRECT END POSITION

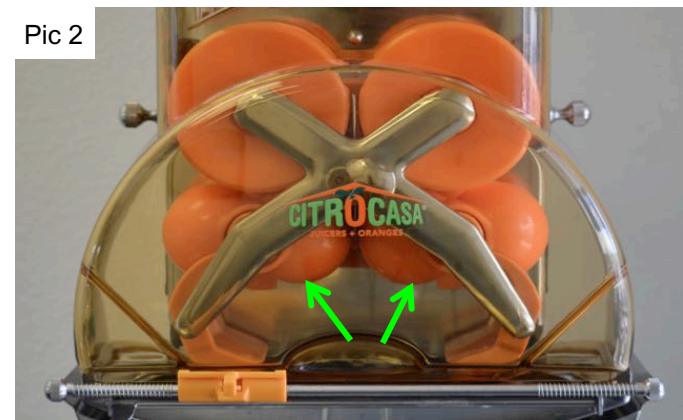

## 8. CLEANING YOUR CITROCASA JUICER

### CLEANING AND MACHINE HYGIENE: INTRODUCTION

- Citrocasa juicers are uniquely designed to **attract attention** while producing the **highest quality juice**. Keeping your equipment and the entire juicing area **clean** is critical for **aesthetic and safety reasons**. A clean, well-maintained machine looks great and contributes to producing a higher quality juice product. By regularly cleaning your equipment you will also prevent the build-up of fruit sugars and make it easier to remove parts and eliminate the risk of bad odors. A clean, well-maintained machine, positioned where your customers can see it, will also help you sell more juice and convey a high-quality, hygienic image.
- The safe handling, cleaning and processing of fruit, and the proper cleaning and sanitizing of the machine are essential to help reduce the risk of food borne illness. Consult your local health department to determine adequate methods of cleaning and storing fruit prior to juicing and storing juice after pressing. Please be sure to follow any local, state, and federal guidelines regarding food safety and hygiene regarding the cleaning and maintenance of your Citrocasa equipment.
- **Citrus America, Inc. highly recommends you develop a cleaning plan based on your daily usage patterns.** Your local distributor can help you develop a cleaning plan. **At an absolute minimum, the equipment should be thoroughly cleaned once per day given any machine usage.** In many cases we do recommend cleaning several times throughout the day. We also recommend using a **cleaning log** for your staff to complete.
- Your Citrocasa equipment has been designed for relatively easy cleaning. All **removable front parts**, with the exception of the clear acrylic front cover, are **dishwasher safe** up to a temperature of 194° F (90 ° C). The **front cover** should be **hand-washed** using warm water and a mild dishwashing soap. Do not use abrasive cleaning agents or pads.
- Wipe down the machine itself and the juicing area on a regular basis using warm water. If you are using a Citrocasa Fantastic Cabinet or a Citrocasa Counter Installation Kit, also be sure to clean the stainless-steel peel chute and all cabinet/kit parts properly.
- Empty the peel buckets on a regular basis to ensure optimal machine operation and increased machine hygiene. **Overflowing peel buckets can cause backup and damage to the machine.**
- On the following pages you will find **detailed instructions** regarding the disassembly and assembly of the front of the machine for cleaning. Please read these instructions thoroughly as they will help you maintain your machine for years of service.

***Please be sure that any employees operating and cleaning the machine have received adequate training to ensure safety, a quality product, and a well-maintained machine.***



## STEP-BY-STEP CLEANING INSTRUCTIONS

The below mentioned cleaning steps must be completed **at least once every 24 hours**. Frequent juicing will require **more frequent cleaning**. For optimal efficiency and hygiene, we recommend using a **cleaning log**.

### IMPORTANT:

- ✓ **Make sure to properly shut down the machine (see page 16).**
- ✓ **Ensure that the machine is disconnected from its power supply. UNPLUG THE MACHINE!**
- ✓ **ATTENTION: DO NOT HOSE OR SPRAY DOWN THE MACHINE!**

**NOTE: All re-movable parts, except for the plastic front cover, can be placed in the dishwasher for cleaning!**

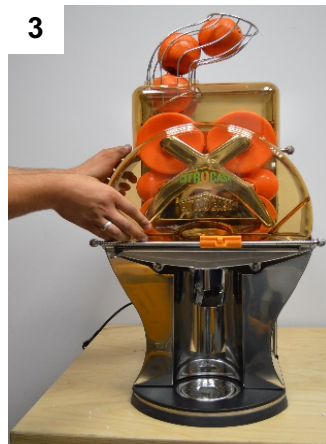
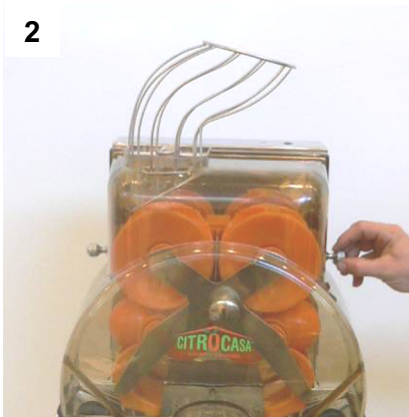

1. Remove the remaining fruit from the fruit supply tunnel by hand or press until the fruit supply tunnel is empty (Pic 1).
2. Loosen the front cover screws left and right (Pic 2).
3. Remove the front cover: Pull the lower part of the front cover slightly toward the front. Then lift the cover away from the retaining bolts up top (Pic 3).

**ATTENTION: DO NOT PLACE THE ACRYLIC FRONT COVER IN THE DISHWASHER. HANDWASH ONLY!** Use mild soap and a soft towel to clean and dry the front cover. Do not use abrasive detergents or pads.

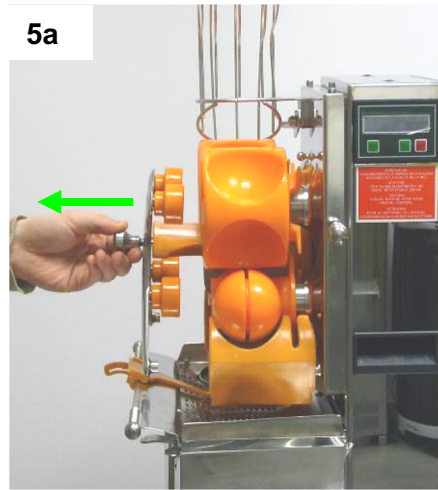

4. Loosen the cross holder screw (Pic 4).

5. Pull the cross holder screw towards you once loosed (Pic 5a) to remove the cross holder assembly (Pic 5b).

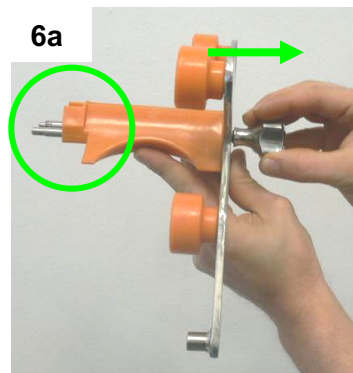

6. Pull out the cross holder screw to separate the knife guide from the cross holder (Pic 6a). You will have three individual parts: the cross holder (1), the knife guide (2) and the screw (3) (Pic 6b).



**ATTENTION:** When re-installing the cross holder, ensure that the blade rests completely in its proper position and that the screw is properly tightened by hand. **Installing the blade or cross holder in the incorrect position may result in serious damage to the blade, the knife system, the pressing units and/or the machine itself.**

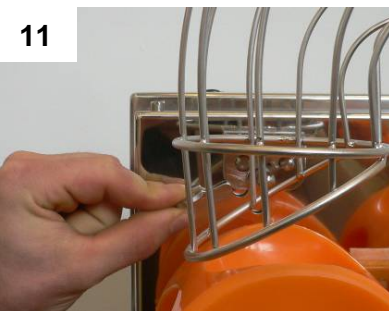
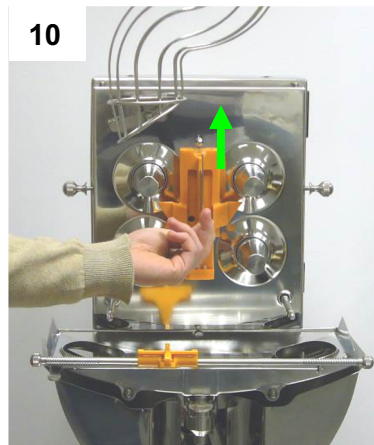
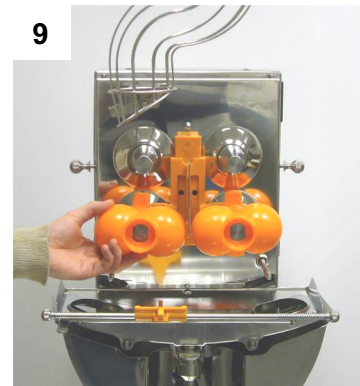
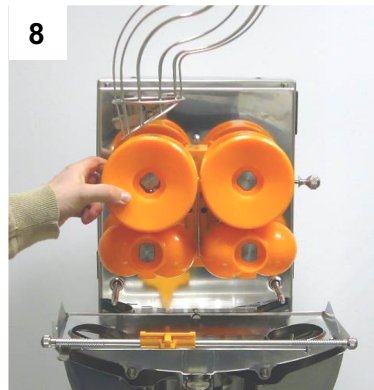
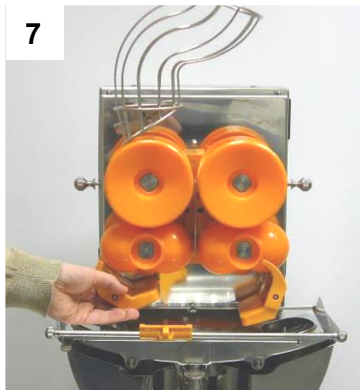

7. Remove the peel ejectors left and right (Pic 7).
8. Remove the upper pressing elements left and right (Pic 8).
9. Remove the lower pressing elements left and right (Pic 9).
10. Lift up the knife and pull it out (Pic 10).

**CAUTION: THE BLADE IS RAZOR SHARP AND CAN CAUSE INJURY! DO NOT HOLD THE BLADE FROM THE SHARP EDGE AT THE TOP!**

**ATTENTION: When re-installing the blade, be sure to mount it with the SHARP EDGE FACING UP.**

11. Open the fruit supply tunnel locking lever and remove the fruit supply tunnel (Pic 11).
12. Remove the double cover (Pic 12).

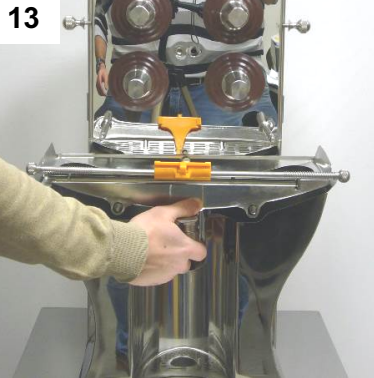

### CLEANING THE MTS SYSTEM:

13. Remove the MTS and sieve support (Pic 13).

14. To remove the MTS swiper, press the fastening clip and pull away from MTS and sieve (Pic 14).

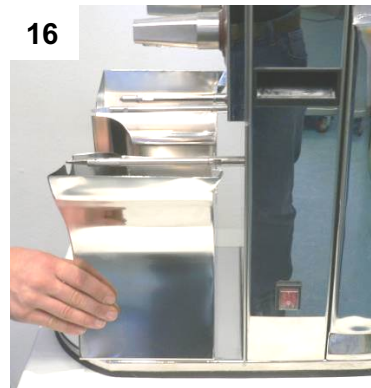
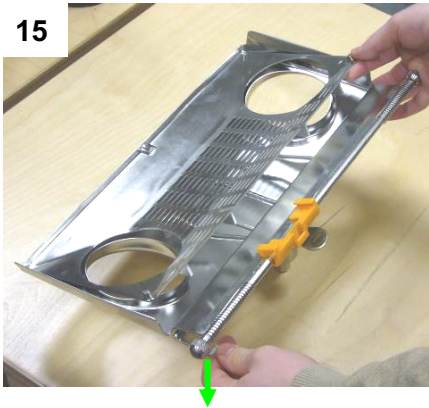

15. Press the lifting lever and remove the fruit sieve from the fruit sieve support (Pic 15). **See page 22 for instructions on how to disassemble and clean the SB tap.**

16. Remove the peel buckets or peel chutes (Pic 16).



17. Remove the drip cup (Pic 17).

18. Remove the tray from the drip cup (Pic 18).



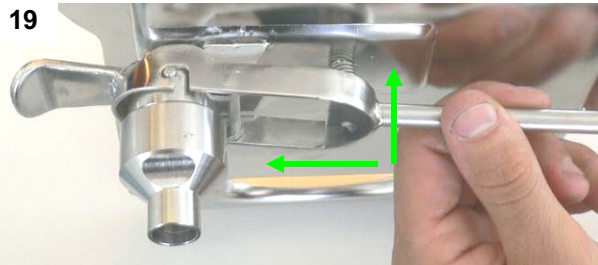

### CLEANING THE SB TAP (only for FANTASTIC M/SB):

Remove and disassemble the tap as follows:

19. Press the tap lever upwards and at the same time push it to the front (Pic 19).

20. Pull the bottom of the tap downwards (Pic 20).

21. Press the tap lever upwards and at the same time push it towards the back (Pic 21a) to release it (Pic 21b).

**Clean all sieve and tap parts (upper and lower part) properly.**

**ATTENTION:** When re-assembling, make sure that the guide bolt of the tap bottom is toward the rear of the machine (Pic 22).

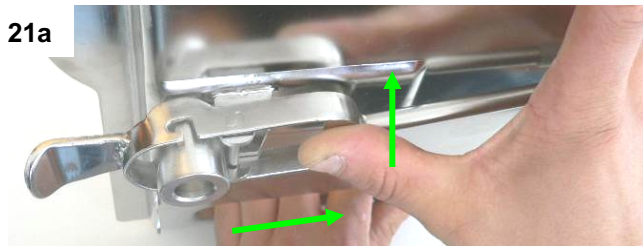



Wipe down the housing with fresh, clean warm water and a soft cloth (Pic 22). Dry thoroughly before reassembling the machine.

Be sure to wipe down the stainless-steel posts and the O-ring seals with fresh, clean warm water to remove any juice residue.





**ATTENTION: The four O-ring seals protect the inside of the machine from juice and increase hygiene and machine life. Be sure to inspect the seals regularly for proper fit and sealing. If you notice the rubber lips coming up or see damage, call your service representative.**

Make sure to regularly clean the entire cabinet area.



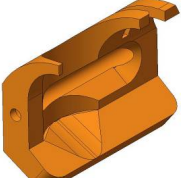
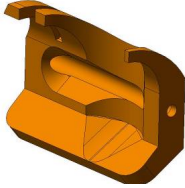
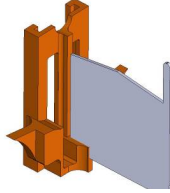
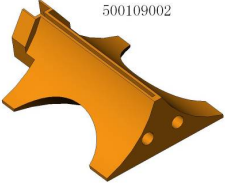
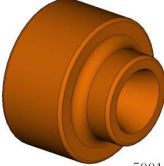

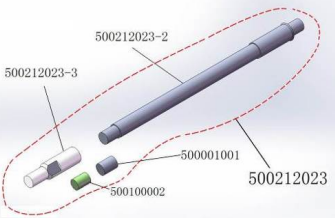
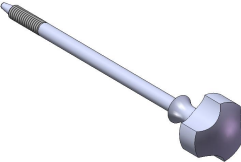
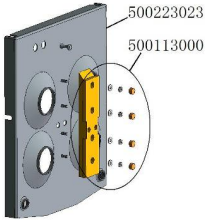
- ✓ **DO NOT SPRAY OR HOSE DOWN THE MACHINE!**
- ✓ **DO NOT USE CHEMICAL CLEANING AGENTS OR ABRASIVES TO CLEAN THE HOUSING AND THE O-RING SEALS. USE FRESH, CLEAN, WARM WATER AND A SOFT TOWEL!**
- ✓ **ALL PARTS EXCEPT FOR THE ACRYLIC FRONT COVER CAN BE PLACED IN THE DISHWASHER FOR CLEANING.**
- ✓ **THE FRONT COVER IS HANDWASH ONLY! USE A NON-ABRASIVE DETERGENT AND A SOFT TOWEL FOR CLEANING.**
- ✓ **DO NOT USE RUNNING WATER TO CLEAN THE FRUIT BASKET AREA. USE FRESH, CLEAN WARM WATER AND A SOFT TOWEL TO WIPE DOWN THE HOUSING AND THE BASKET AREA.**
- ✓ **RE-ASSEMBLE ALL PARTS IN THE REVERSE ORDER OF REMOVAL! ENSURE THAT ALL PARTS ARE MOUNTED CORRECTLY BEFORE YOU RESUME JUICING!**
- ✓ **REVIEW THE LAMINATED SHORT CLEANING INSTRUCTIONS DOCUMENT INCLUDED.**
- ✓ **VISIT: [www.citruamerica.com/training.com](http://www.citruamerica.com/training.com) FOR DETAILS ON OPERATING AND CLEANING.**

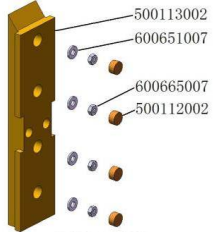
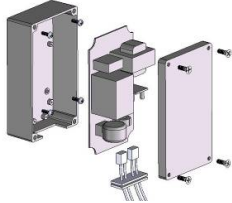
## 9. SPARE PARTS

Be sure to provide machine model and serial number when ordering spare parts to ensure that the proper parts are supplied.  
For additional spare parts not listed below, please contact your customer service representative or Citrus America directly.

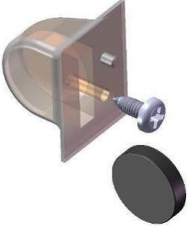
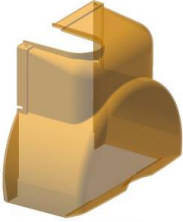
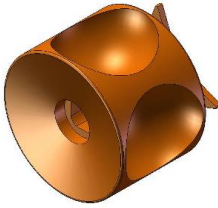
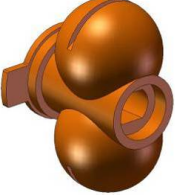
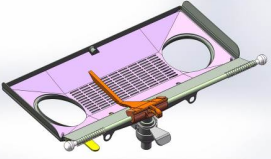
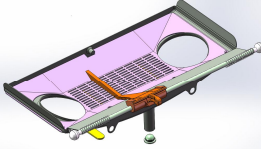
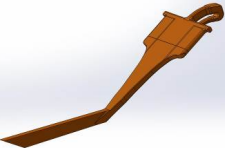
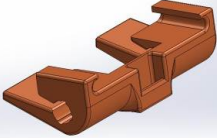
|  |   |  |  |  |  |
|--|---|--|--|--|--|
|   | <p>Peel ejector left<br/>Art. No. 500.104.100</p>         |   | <p>Peel ejector right<br/>Art. No. 500.105.100</p>             |                                 | <p>SCS up &amp; down<br/>knife system<br/>Art. No. 500.108.022</p>           |
|  <p>500109002</p>   | <p>Knife guide<br/>Art. No. 500.109.002</p>               |  <p>500111002</p>   | <p>Cross holder knob<br/>Art. No. 500.111.012</p>              |  <p>500211003</p>               | <p>Cross holder<br/>Art. No. 500.212.000</p>                                 |
|  <p>500212023-2<br/>500212023-3<br/>500001001<br/>500100002<br/>500212023</p> | <p>Cross holder<br/>bolt<br/>Art. No.<br/>500.212.023</p> |   | <p>Cross holder screw<br/>Art. No. 500.213.023</p>             |  <p>500223023<br/>500113000</p> | <p>Double cover<br/>complete<br/>Art. No. 500.223.030</p>                    |
|   | <p>Front cover screw<br/>Art. No. 500.225.003</p>         |  <p>500113002<br/>600651007<br/>600665007<br/>500112002</p> | <p>Knife guide mount<br/>complete<br/>Art. No. 500.113.020</p> |                               | <p>Electronic box / Main<br/>electronics<br/>Art. No.<br/>500.280.000-V2</p> |

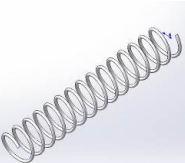
Be sure to provide machine model and serial number when ordering spare parts to ensure that the proper parts are supplied.  
For additional spare parts not listed below, please contact your customer service representative or Citrus America directly.

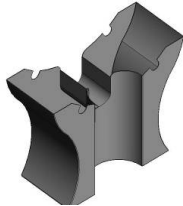
|   |  |   |   |   |   |
|---|--|---|---|---|---|
|    | <p>Front cover magnet<br/>and magnet cover<br/>Art. No. 600.653.000</p>                |    | <p>Front cover Fantastic<br/>Art. No. 500.110.020</p>         |    | <p>Upper pressing<br/>element (Standard<br/>size)<br/>Art. No.<br/>800.160.022/032</p>  |
|    | <p>Lower pressing<br/>element (Standard<br/>size)<br/>Art. No.<br/>500.106.002/012</p> |    | <p>MTS system Fantastic<br/>M/SB<br/>Art. No. 500.288.000</p> |    | <p>MTS system<br/>Fantastic M/AS<br/>Art. No. 500.289.000</p>                           |
|    | <p>MTS swiper<br/>Fantastic<br/>Art. Nr. 500.286.003</p>                               |    | <p>MTS swiper support<br/>Art. No. 800.131.002</p>            |    | <p>MTS system screw<br/>Art. Nr. 500.299.003</p>  |
|  | <p>MTS system spring<br/>Art. No. 500.287.003</p>                                      |  | <p>Drip cup<br/>Art. No. 500.200.002</p>                      |  | <p>Peel bucket<br/>Art. No. 500.216.053<br/><br/>Peel chute<br/>Art. No 500.276.083</p> |

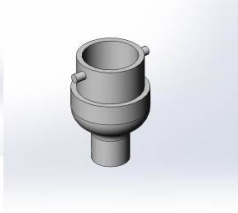
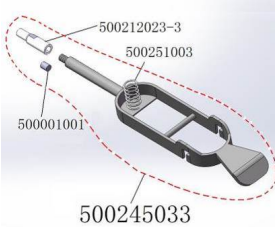
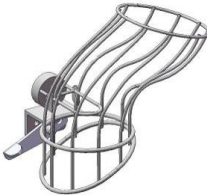
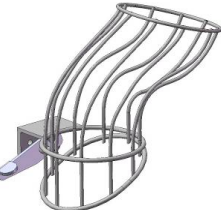

Be sure to provide machine model and serial number when ordering spare parts to ensure that the proper parts are supplied.  
 For additional spare parts not listed below, please contact your customer service representative or Citrus America directly.

|   |  |   |   |   |  |
|---|--|---|---|---|--|
|  | <p>Lower SB tap<br/>         Art. No. 500.268.070</p>  |  | <p>SB tap lever<br/>         Art. No. 500.245.043</p> |  | <p>Fruit supply tunnel<br/>         Fantastic M/AS<br/>         Art. No.<br/>         500.207.AS23</p> |
|  | <p>Fruit supply tunnel<br/>         Fantastic M/SB<br/>         Art. No.<br/>         500.207.SB23</p> |   |   |   |  |

## 10. CERTIFICATIONS

All Citrocasa machines have been NSF certified and are certified to meet UL-763 and be in compliance with normal OSHA requirements as certified by a Nationally Recognized Testing Laboratory (NRTL). Should you require updated certification documents, please contact your representative or our toll-free number/technical service at: 1-855-MY-CITRO (855-692-4876).



### Questions or suggestions?

Call our toll-free number: 1-855-MY-CITRO (855-692-4876)

*Citrocasa, TMP GmbH, and Citrus America, Inc. reserve the right to make technical changes and modifications to the equipment and specifications. We do our best to supply accurate and up to date information. Even so, from time to time information that is inaccurate or out of date may be in our documentation. Should you find issues or have questions, please contact us at our toll-free technical service hotline listed above.*