



**CTB AND CTBR  
CONVECTION OVEN  
INSTALLATION - OPERATION - MAINTENANCE**



**BLODGETT OVEN COMPANY**

[www.blodgett.com](http://www.blodgett.com)

42 Allen Martin Drive, Essex Junction, Vermont 05452 USA Telephone: (802) 658-6600 Fax: (802)864-0183

PN 11361 Rev X (7/19)

© 2019 - G.S. Blodgett Corporation

Your Service Agency's Address:

\_\_\_\_\_

Model

\_\_\_\_\_

Serial number

\_\_\_\_\_

Oven installed by

\_\_\_\_\_

Installation checked by

# IMPORTANT

**WARNING:** Improper installation, adjustment, alternation, service or maintenance can cause property damage, injury or death. Read the installation, operation and maintenance instructions thoroughly before installing or servicing this equipment.

## FOR YOUR SAFETY

Do not store or use gasoline or other flammable vapors or liquids in the vicinity of this or any other appliance.

The information contained in this manual is important for the proper installation, use, and maintenance of this oven. Adherence to these procedures and instructions will result in satisfactory baking results and long, trouble free service. Please read this manual carefully and retain it for future reference.

**ERRORS:** Descriptive, typographic or pictorial errors are subject to correction. Specifications are subject to change without notice.

# TABLE OF CONTENTS

## INSTALLATION

Oven Description and Specifications.....	2
Delivery and Location .....	3
Stand Assembly.....	4
Oven Assembly.....	6
Oven Assembly to Stand.....	6
4" (10cm) Leg Attachment.....	7
Caster Installation .....	7
Oven leveling .....	7
Adjustments Associated with Initial Installation.....	7
Utility Connections - Standards and Codes.....	8
Electrical Connection.....	9

## OPERATION

Safety Information .....	10
Solid State Manual .....	11
Solid State Digital .....	12
Simple Touch Touchscreen Control .....	14
CH-Pro3 (Solid State Programmable Digital Control).....	28
Blodgett IQ2™ Vision Control.....	31
How Cook & Hold Works .....	41
General Guidelines for Operating Personnel.....	42
Suggested Times and Temperatures .....	43

## MAINTENANCE

Cleaning and Preventative Maintenance.....	44
Troubleshooting Guide .....	35



# Installation

## Oven Description and Specifications

Cooking in a convection oven differs from cooking in a conventional deck or range oven since heated air is constantly recirculated over the product by a fan in an enclosed chamber. The moving air continually strips away the layer of cool air surrounding the product, quickly allowing the heat to penetrate. The result is a high quality product, cooked at a lower temperature in a shorter amount of time.

Blodgett convection ovens represent the latest advancement in energy efficiency, reliability, and ease of operation. Heat normally lost, is recirculated within the cooking chamber before being vented from the oven: resulting in substantial reductions in energy consumption and enhanced oven performance.

ELECTRICAL RATINGS- CTB & CTBR							
VOLTAGE	KW	PHASE	MAX LOAD (AMPS)				ELECTRICAL CONNECTION AWG*
			L1	L2	L3	N	
<b>60 HZ</b>							
208	5.6	1	27	—	27	—	8
	5.6	3	24	12	15	—	10
	6.8	1	33	—	33	—	6
	6.8	3	20	18	19	—	10
	8.0	1	35	—	35	—	6
	8.0	3	22	20	21	—	10
220-240	5.6	1	24	—	24	—	8
	5.6	3	21	11	14	—	10
	6.8	1	28	—	28	—	6
	6.8	3	18	16	17	—	10
	8.0	1	32	—	32	—	6
	8.0	3	20	18	19	—	10
<b>50 HZ</b>							
220-240	5.6	1	24	—	—	24	Size per local codes
	6.8	1	28	—	28	—	
	8.0	1	35	—	—	35	
240/415	5.6	3 WYE	11	0	9	3	Size per local codes
	6.8	3 WYE	11	9	9	—	
	8.0	3 WYE	13	11	11	2	
230/400	5.6	3 WYE	11	0	10	1	Size per local codes
	6.8	3 WYE	11	9	9	—	
	8.0	3 WYE	13	11	11	2	

\* Electric connection wiring is sized for 90°C copper wire at 125% of rated input.

**NOTE:** Double units can have phase loads partially equalized by matching lines during hook-up. Otherwise, CTB-Double or CTBR-Double load ratings are twice the above data.

## Delivery and Location

### DELIVERY AND INSPECTION

All Blodgett ovens are shipped in containers to prevent damage. Upon delivery of your new oven:

- Inspect the shipping container for external damage. Any evidence of damage should be noted on the delivery receipt which must be signed by the driver.
- Uncrate the oven and check for internal damage. Carriers will accept claims for concealed damage if notified within fifteen days of delivery and the shipping container is retained for inspection.

The Blodgett Oven Company cannot assume responsibility for loss or damage suffered in transit. The carrier assumed full responsibility for delivery in good order when the shipment was accepted. We are, however, prepared to assist you if filing a claim is necessary.

### OVEN LOCATION

The well planned and proper placement of your oven will result in long term operator convenience and satisfactory performance.

The following clearances must be maintained between the oven and any combustible or non-combustible construction.

#### CTB

- Oven body left side - 0" (0cm)
- Oven body back - 0" (0cm)

#### CTBR

- Oven body right side - 0" (0cm)
- Oven body back - 0" (0cm)

It is essential that an adequate air supply to the oven be maintained to provide a sufficient flow of combustion and ventilation air.

- Area must be accessible for proper servicing.
- Keep the oven area free and clear of all combustibles such as paper, cardboard, and flammable liquids and solvents.
- To ensure proper operation, ventilation must not be obstructed in any way. Tripping of the blower motor thermal overload protective device is caused by excessive ambient temperature on the control side of the oven resulting from insufficient ventilation. This condition must be corrected immediately to avoid permanent damage to the oven.

Before making any utility connections to this oven, check the rating plate to be sure the oven specifications are compatible with the electrical services supplied for the oven.

1. The rating plate is attached to the underside of the oven upper ledge above the control panel.
- Do not place strong sources of heat such as open flame ranges, griddles, or charbroilers near the oven. If such an instance exists, it is highly recommended to purchase a heat shield, available from Blodgett.
  - Note that if temperatures are too high, a safety shut-down may occur.
  - Failure to comply may invalidate the oven warranty.



# Installation

## Stand Assembly

### STAND OPTIONS

#### Small Stands Without Shelves

- The 5-3/4" (15cm) stand is used for a single oven, when short legs are required for countertop use.
- The 7" (18cm) stand is used for a double stacked oven, when the oven is to be located on the floor.

#### Stands With Shelves

- Three stands, 16" (40cm), 19" (48cm), and 24" (61cm) are available for different installation requirements.
- The 33" (84cm) stand is used for a single oven when counter space is limited.

#### Open Stands With Racks

- The 24" (61cm) or 33" (84cm) open stands are available with a rack support system located below the oven.

### Stands With Shelves

1. Place stand frame upside down on a work surface.
2. Attach one leg to each of the corner stud bolts on the bottom of the stand top.
3. Place a lock washer and nut on each bolt, and tighten. DO NOT tighten leg bolts completely.
4. Place the shelf between the legs so that the smooth top surface is facing the top of the stand.
5. Align the shelf holes with the bolt holes found near the bottom of each leg.
6. Insert a carriage bolt from the outside of the leg, through the leg, and through the shelf corner bracket.
7. Place a lock washer and nut on each bolt, and tighten securely.
8. Tighten the leg frame bolts.

### STAND ASSEMBLY

#### Small Stands Without Shelves

1. Place stand frame upside down on a work surface.
2. Attach one leg to each of the corner stud bolts on the bottom of the stand top.
3. Place a lock washer and nut on each stud, and tighten securely.

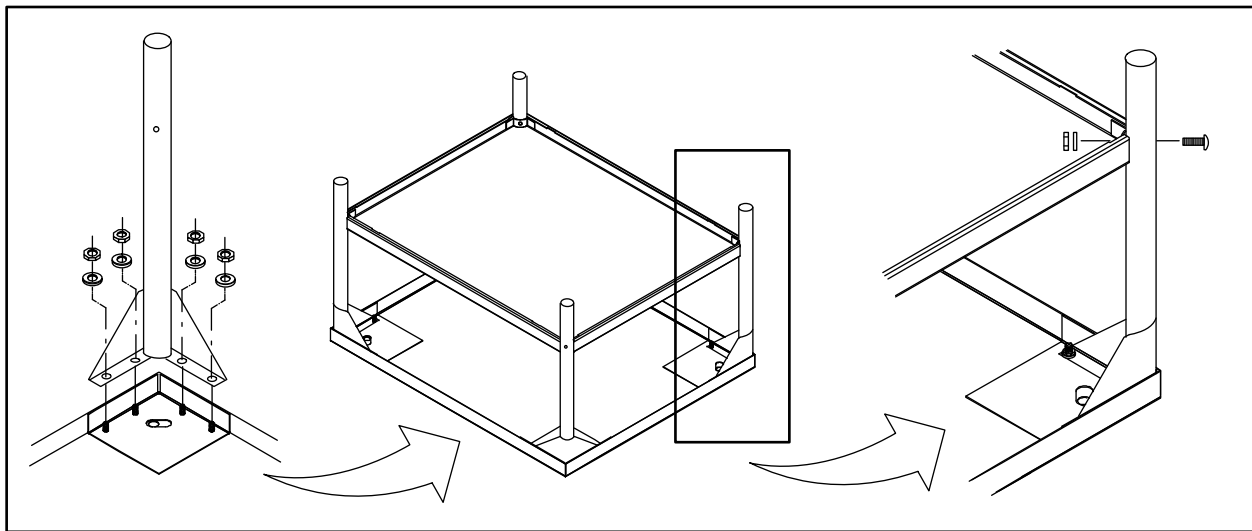

Figure 1

## Stand Assembly

### Open Stands With Shelves and Racks

1. Place stand frame upside down on a work surface.
2. Attach one leg to each of the corner stud bolts on the bottom of the stand top.
3. Place a lock washer and nut on each bolt, and tighten. **DO NOT** tighten leg bolts completely.
4. Attach the rack support angles to the stud bolts on the bottom of the stand top with the nuts provided.

Each support angle has 2 clips on one end and 1 clip on the other end. The two clips should be at the back of the stand facing toward the center.

**IMPORTANT - Be sure the support angles and clips are located correctly for your oven configuration as shown.**

5. Position the bottom shelf between the legs so that the smooth top surface is facing the top of the stand.
6. Align the shelf holes with the bolt holes found near the bottom of each leg.

7. Insert a carriage bolt from the outside of the leg, through the leg, and through the shelf corner bracket.
8. Place a lock washer and nut on each bolt, and tighten securely.
9. Repeat Steps 5-8 for the top shelf.

*NOTE: Be sure the slots in the top shelf are aligned with the support angles.*

10. Insert the top of the rack stops into the two back clips on the angle supports as shown. Insert the bottom of the rack stops into the slots in the top shelf as shown.
11. Insert the rack supports into the remaining four clips on the angle supports as shown. Insert the bottom of the rack supports into the slots in the top shelf as shown.
12. Tighten all loose bolts.

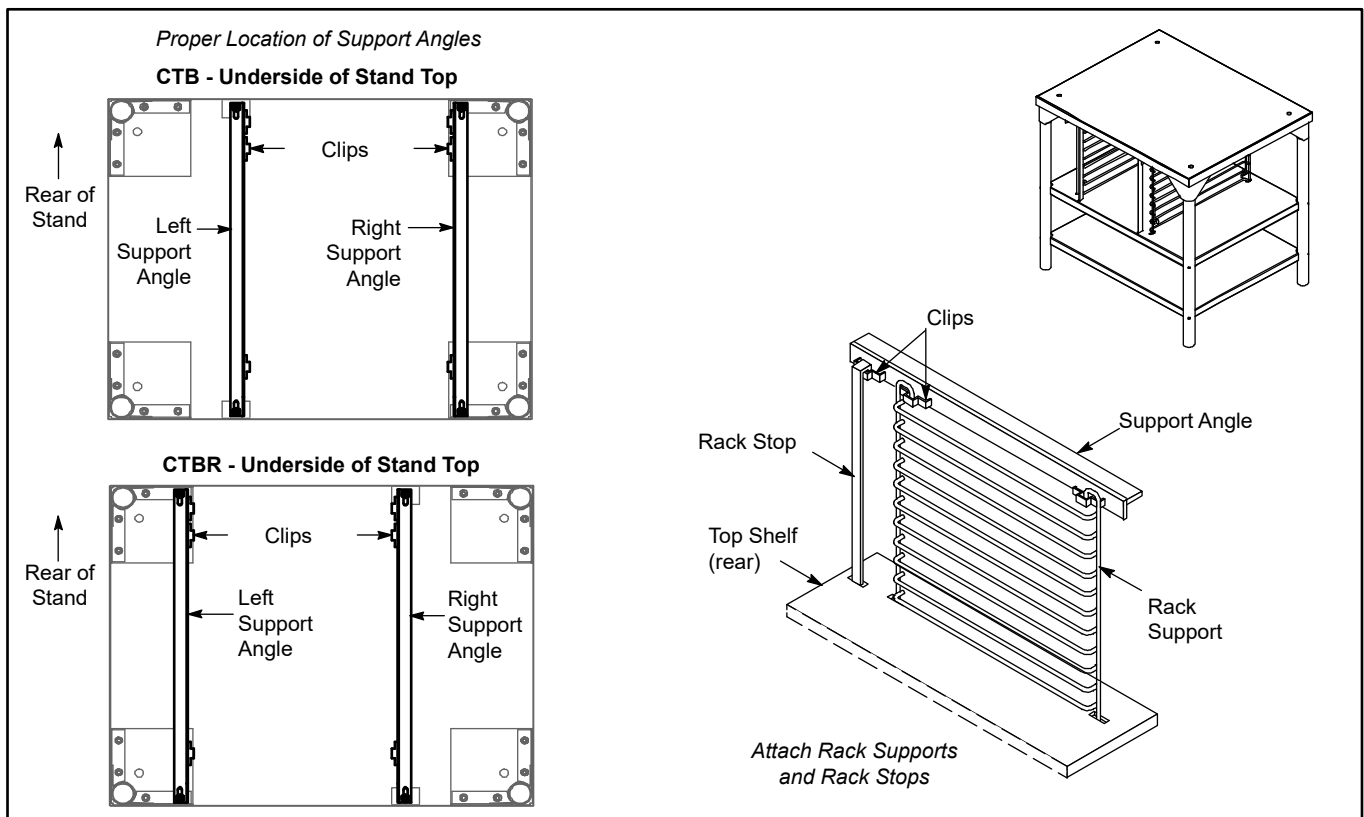

Figure 2



# Installation

## Oven Assembly

### OVEN ASSEMBLY TO STAND

#### Single Section

1. Place the assembled stand in the location where the oven is going to be used.
2. Remove the side control compartment cover and open the front control panel of a single oven (or lower section).
3. With a tool, punch out the knock-outs in the oven bottom near each corner.
4. Set the oven on the stand. Center it to the frame.
5. Align the front, and rear bolt holes of the oven with the bolt holes in the stand.
6. Insert a bolt and washer, from the top down through each of the 2 holes.
7. Place a nut and washer on each of the 2 bolts, and tighten securely.
8. Replace the oven's side control compartment, and close the front control panel.

*NOTE: For single section ovens only. For double stacked ovens this step will be completed once the ovens are stacked.*

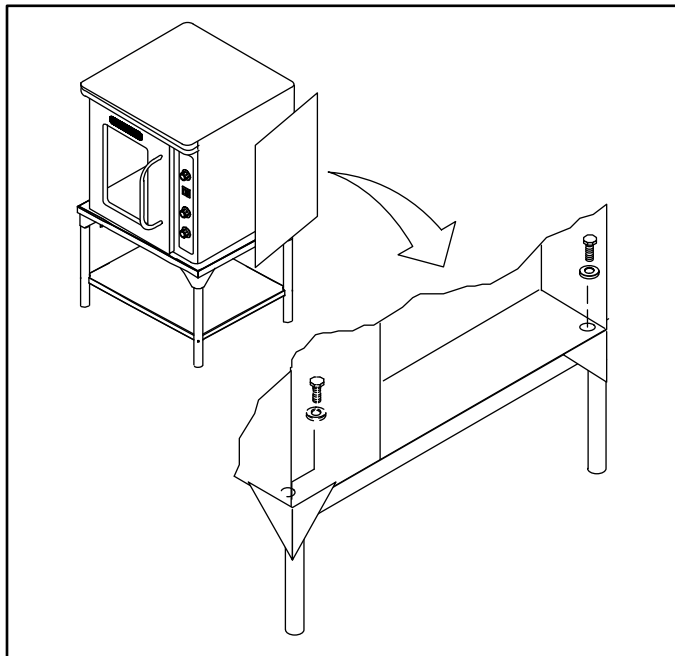

Figure 3

#### Double Section

1. Assemble the lower section to the stand as described. DO NOT replace the side control compartment or close the front control panel.
2. With a tool, punch out the knock-outs in the oven top of the lower oven.
3. Remove the side control compartment cover and open the front control panel of the upper oven.
4. With a tool, punch out the knock-outs in the bottom of the upper oven near each corner.
5. Set the upper oven on the lower oven.
6. Align the front, and rear bolt holes of the upper oven with the bolt holes in the bottom oven.
7. Insert a bolt and washer, from the top down through each of the 2 holes.
8. Place a nut and washer on each of the 2 bolts, and tighten securely.
9. Replace the control compartment cover, and close the front control panel on both of the ovens.

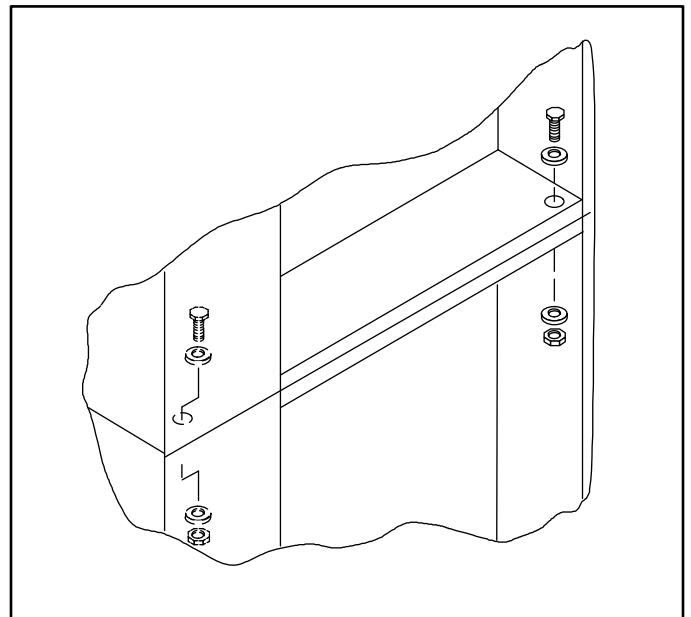

Figure 4



## Oven Assembly

### 4" (10CM) LEG ATTACHMENT

1. Lay the oven on its side.
2. Screw one leg into each of the corner nuts.

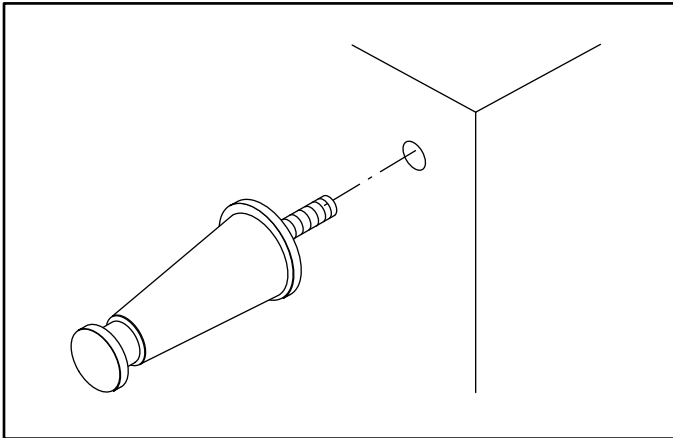

Figure 5

### CASTER INSTALLATION

*NOTE: Casters are not supplied for the 4" (10cm) legs, 5-3/4" (15cm) or 7" (18cm) stands.*

*NOTE: Install the locking casters on the front of the oven. Install the non-locking casters on the back of the oven.*

1. Insert the caster into the leg. Secure the caster to the leg by tightening the locknut.

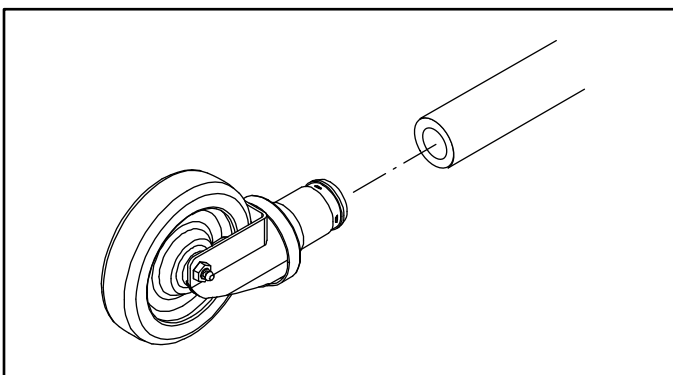

Figure 6

### OVEN LEVELING

After assembly, the oven should be leveled and moved to the operating location.

1. The oven can be leveled by adjusting the feet or casters located on the bottom of each leg.

### ADJUSTMENTS ASSOCIATED WITH INITIAL INSTALLATION

Each oven, and its component parts, have been thoroughly tested and inspected prior to shipment. However, it is often necessary to further test or adjust the oven as part of a normal and proper installation. These adjustments are the responsibility of the installer, or dealer. Since these adjustments are not considered defects in material or workmanship, they are not covered by the Original Equipment Warranty. They include, but are not limited to:

- calibration of the thermostat
- adjustment of the doors
- leveling
- tightening of fasteners.

No installation should be considered complete without proper inspection, and if necessary, adjustment by qualified installation or service personnel.



# Installation

---

## Utility Connections - Standards and Codes

THE INSTALLATION INSTRUCTIONS CONTAINED HEREIN ARE FOR THE USE OF QUALIFIED INSTALLATION AND SERVICE PERSONNEL ONLY. INSTALLATION OR SERVICE BY OTHER THAN QUALIFIED PERSONNEL MAY RESULT IN DAMAGE TO THE OVEN AND/OR INJURY TO THE OPERATOR.

Qualified installation personnel are individuals, a firm, a corporation, or a company which either in person or through a representative are engaged in, and responsible for:

- the installation of electrical wiring from the electric meter, main control box or service outlet to the electric appliance.
- Qualified installation personnel must be experienced in such work, familiar with all precautions required, and have complied with all requirements of state or local authorities having jurisdiction.

U.S. and Canadian installations

All ovens, when installed, must be electrically grounded in accordance with local codes, or in the absence of local codes, with the National Electrical Code, ANSI/NFPA 70-Latest Edition and/or Canadian National Electric Code C22.2 as applicable.

The ventilation of this oven should be in accordance with local codes. In the absence of local codes, refer to the National ventilation code titled, "Standard for the Installation of Equipment for the Removal of Smoke and Grease Laden Vapors from Commercial Cooking Equipment", NFPA-96-Latest Edition.

### General export installations

Installation must conform with Local and National installation standards. Local installation codes and/or requirements may vary. If you have any questions regarding the proper installation and/or operation of your Blodgett oven, please contact your local distributor. If you do not have a local distributor, please call the Blodgett Oven Company at 0011-802-658-6600.





Wiring diagrams are located in the control compartment area.

Ovens are supplied for operation in several voltage choices, single or three phase grounded circuits.

The electric motor, indicator lights and related switches are interconnected through the one power source supplied to the oven.

1. The supply conduit enters through the rear of the oven and electrical block secured to the perforated panel at the back of the control compartment.

The Blodgett Oven Company cannot assume responsibility for loss or damage suffered



# Operation

---

## Safety Information

The information contained in this section is provided for the use of qualified operating personnel. Qualified operating personnel are those who have carefully read the information contained in this manual, are familiar with the functions of the oven and/or have had previous experience with the operation of the equipment described. Adherence to the procedures recommended herein will assure the achievement of optimum performance and long, trouble-free service.

Please take the time to read the following safety and operating instructions. They are the key to the successful operation of your Blodgett oven.



### SAFETY TIPS

**For your safety read before operating**

### General safety tips:

- If the oven needs to be moved for any reason, the supply cord must be disconnected from the unit before removing the restraint cable. Reconnect the restraint after the oven has been returned to its original location.
- DO NOT remove the control panel cover unless the oven is unplugged.

### COMPONENT DESCRIPTION

1. SELECTOR SWITCH - controls power to the oven and selects Cool Down mode.
2. OVEN READY LIGHT - when lit, indicates heater operation. When the light goes out, the oven has reached operating temperature.
3. SOLID STATE THERMOSTAT - allows either 8 pre-set temperatures to be selected in accordance with customer requirements, or an infinite selection of temperatures from 200-500°F (95-260°C).

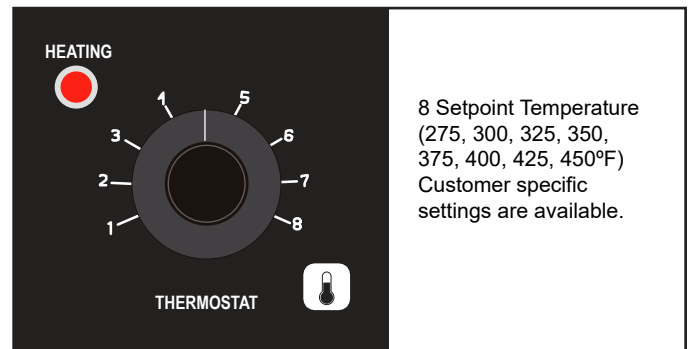

Figure 7

4. COOK TIMER - used to time the length of the cooking operation. When the set time expires an alarm sounds.

### CONTROL OPERATION

1. Turn the SELECTOR SWITCH (1) to OVEN ON.
2. Set the COOK THERMOSTAT (3) to the desired temperature.
3. Preheat the oven until the OVEN READY (2) light goes out, indicating the oven has reached operating temperature.
4. Load product into the oven. Set the COOK TIMER (4) to the desired time.
5. When the buzzer sounds, remove the product from the oven. Turn the timer to OFF to silence the alarm.
6. Turn the SELECTOR SWITCH (1) to OVEN OFF.

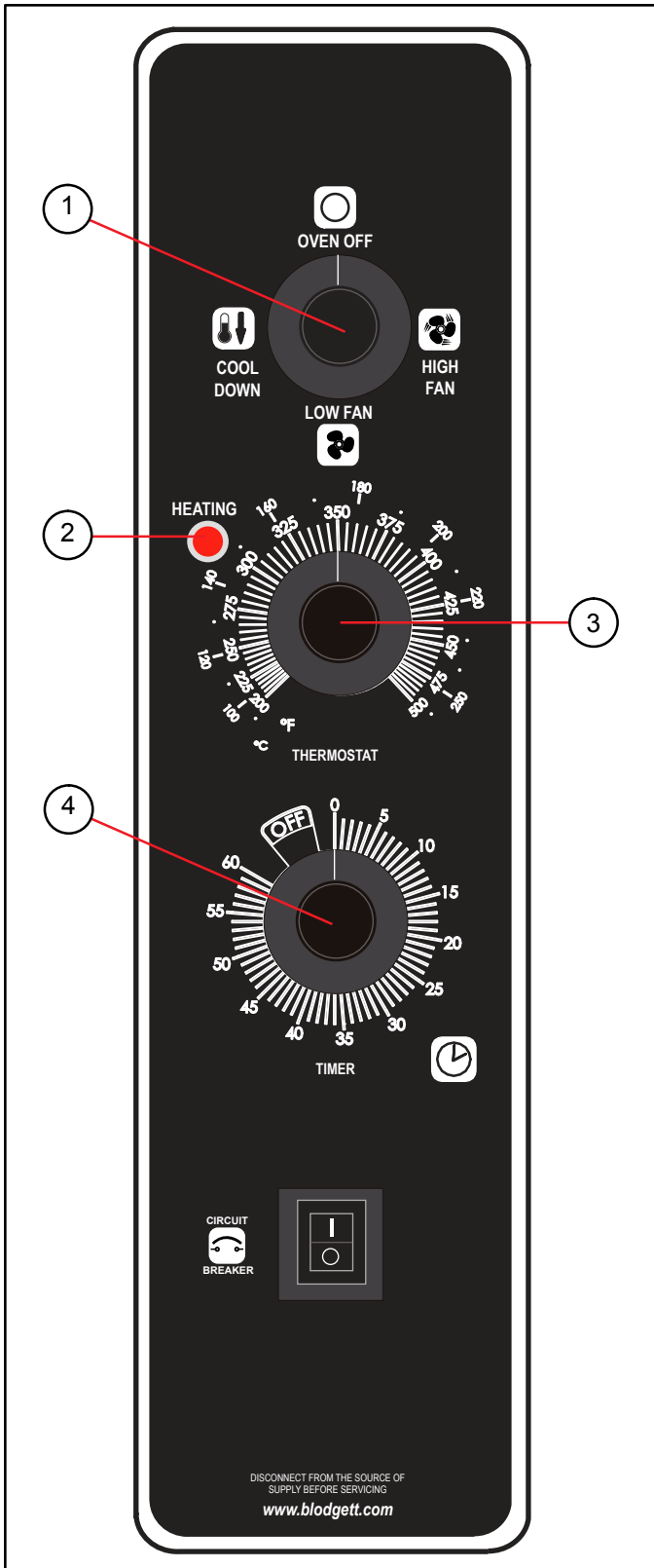

Figure 8



# Operation

## Solid State Digital

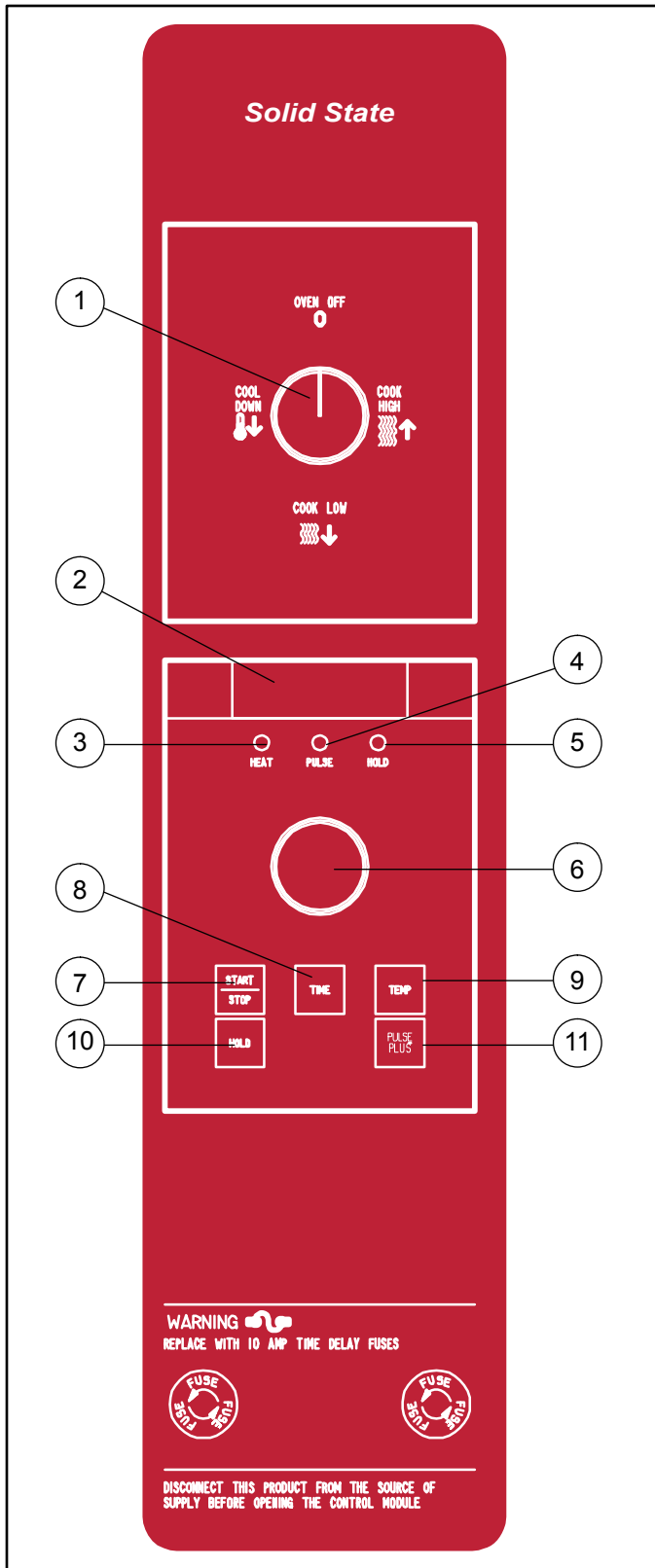

Figure 9

### COMPONENT DESCRIPTION

1. SELECTOR SWITCH - turns power to the oven on or off. Allows selection of Cook or Cool Down modes and fan speed (if applicable).
  2. DISPLAY - displays time, temperature, or other information related to oven function.
  3. HEAT LAMP - lights when heater is on.
  4. PULSE LAMP - lights when Pulsed Fan Mode is turned on.
  5. HOLD LAMP - lights when Hold Mode is turned on.
  6. DIAL - used to enter set points in display.
  7. START/STOP KEY - starts or stops the timer.
  8. TIME KEY - used to show time in the display.
  9. TEMP KEY - used to show set temperature in the display.
- NOTE: Actual temperature is shown while the TEMP key is held down.*
10. HOLD KEY - turns Hold Mode on or off.
  11. PULSE KEY - turns Pulse Mode on or off.

### PROGRAMMING

#### To set the cook temperature:

1. Press the TEMP (9) key.
2. Rotate the dial (6) to enter the cook temperature.

#### To set the cook time:

1. Press the TIME (8) key.
2. Rotate the dial (6) to enter the cook time.

*NOTE: Time is entered in hours : minutes or minutes : seconds.*

#### To set the hold time:

1. Press the HOLD key (10) to turn hold mode on.
- NOTE: HOLD light is on.*
2. Rotate the dial (6) to enter the hold temperature.
  3. Press the START/STOP key (7)

#### To set the pulse time:

1. Press the PULSE KEY (11) to turn pulse mode on.
- NOTE: Pulse light is on.*
2. Rotate the DIAL (6) to enter the pulse time. Pulse time is a portion of the pre-set cook time.

### OPERATION

#### Cook

1. Turn the SELECTOR SWITCH (1) to the desired position.
2. Enter the cook time and temperature.
3. Load product into the oven.

*NOTE: The display reads LOAD when the oven is near set temperature.*

4. Push the START/STOP key (7). The timer begins to count down.
5. When the cook timer reaches 00:00 the buzzer sounds and the display reads DONE.
6. Press the START/STOP key (7) to silence the buzzer.
7. Remove the product.

#### Cook with Hold

*NOTE: The HOLD light is on when hold mode is on and off when hold mode is off.*

1. Turn the SELECTOR SWITCH (1) to the desired position.
2. Enter the cook time and temperature.
3. Press the HOLD key (10). Enter the hold temperature.
4. Load product into the oven.

*NOTE: The display reads LOAD when the oven is near set temperature.*

5. Push the START/STOP key (7). The timer begins to count down.
6. When the cook timer reaches 00:00 the buzzer sounds and the display reads DONE. The buzzer turns off after a few seconds. The display reads HOLD until the oven reaches the hold temperature. Then the timer begins to count up.
7. Push the START/STOP key (7) to stop the timer.
8. Remove the product.
9. Push the HOLD key (10) to turn off hold mode.

### COOK WITH PULSE

*NOTE: The PULSE light is on when pulse mode is on and off when pulse mode is off.*

1. Turn the SELECTOR SWITCH (1) to the desired position.
2. Enter the cook time and temperature.
3. Press the PULSE KEY (11). Enter the pulse time.

*NOTE: Pulse time is a portion of the cook time and does not increase the previously entered cook time.*

4. Load product into the oven.

*NOTE: The display reads LOAD when the oven is near the set temperature.*

5. Push the START/STOP KEY (9). The timer begins to count down the cook time. The oven remains in pulse mode for the set pulse time. When the set time expires, the unit automatically switches to cook mode and continues counting down.
6. When the cook timer reaches 00:00 the buzzer sounds and the display reads DONE.
7. Push the START/STOP KEY (9) to turn the buzzer off.
8. Remove the product.



# Operation

## Simple Touch Control

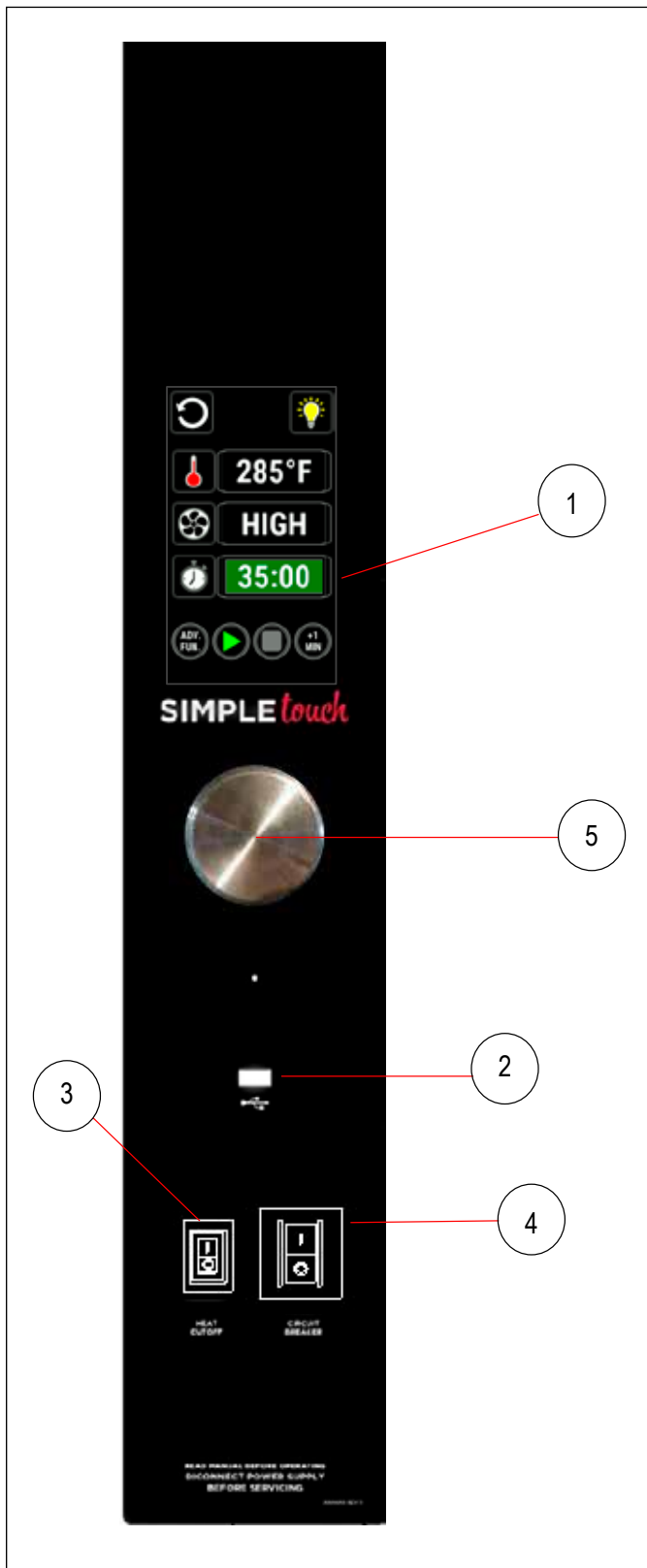

### COMPONENT DESCRIPTION

1. TOUCHSCREEN - Interactive display for oven functioning and/or programming.
2. USB Port - Use to transfer recipes and data to/from the control.
3. HEAT CUTOFF - Used to turn heat source off.
4. CIRCUIT BREAKER – Provides circuit protection for the oven controls. DO NOT use as a power switch.
5. CONTROL KNOB - Used to change values for time, temperature, humidity, etc.

Figure 10



**MANUAL MODE COOKING**

1. Press POWER to turn on the oven.
2. Press MANUAL to proceed to the manual cook screen.

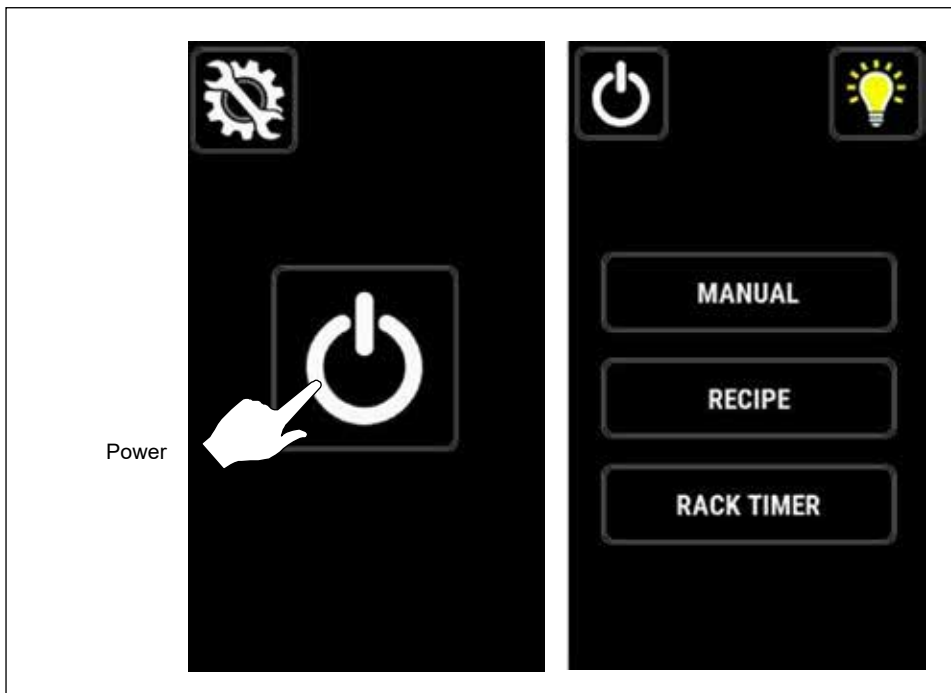

Figure 11



# Operation

## Simple Touch Control

### MANUAL COOK SCREEN

**Actual Temp** – Press thermometer to display the actual cavity temperature.

**Temperature Bar** - Press the TEMPERATURE BAR and use the control dial to set the desired oven temperature.

For temperature ranges from minimum to 215°F, the temperature may be set in 1° increments as the knob is turned.

For temperature above 215°F, the temperature may be set in 5° increments.

Press the check mark to save the selection. Press the X to cancel editing without altering current set point value.

**Cook Timer** - Press the TIMER STATUS BAR and enter the desired cook time using the control dial.

Times greater than 1 hour can be set in 5 minute increments. Times less than 1 hour can be set in 5 second increments.

Press the check mark to save the selection. Press the X to cancel editing without altering current set point value.

**Add a Minute** - Press +1 MIN to add 1 minute of time at any point during the cook cycle.

**Light Activation** - Press the LIGHT icon turn the cavity lights on. The icon will change when activated. The lights will remain on until the icon is pressed again by the user OR the timeout period is reached. The default timeout period is 5 minutes.

**Fan Speed Bar** - Press the FAN SPEED BAR to cycle through the available fan speeds.

**Advanced Functions** – Press the ADV. FUN icon to access the Fan Pulse, Fan Delay and Cook and Hold functions.

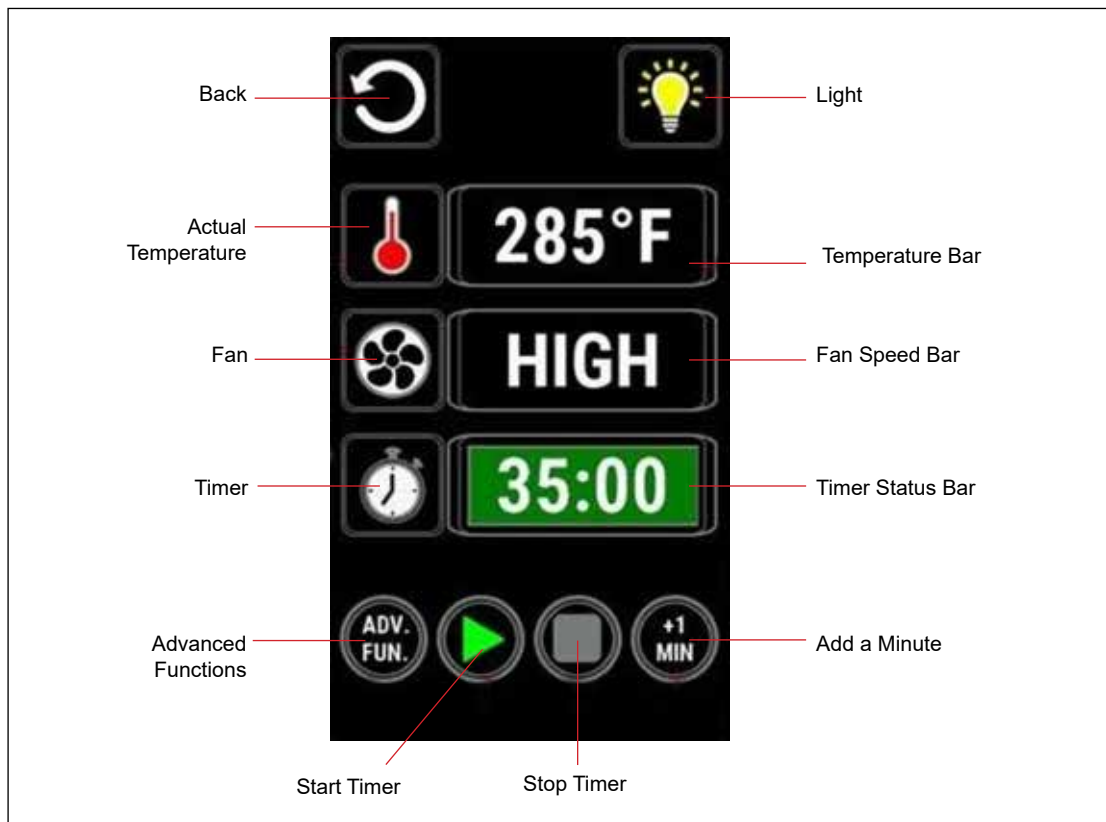

Figure 12

### TO OPERATE TIMER

1. Press PLAY to initiate timer. The timer counts down.,  
The play button changes to pause.

Press the PAUSE button to stop the timer at current value. The pause button changes back to play. Press play to resume timer.

Press the STOP key to clear the timer.

The +1 MIN key may be selected at any time to add an additional minute to the current timer.

### Timer Status Bar

The color of the timer bar represents a percentage of original set time.

- GREEN: 50-100% of the time remains
- ORANGE: 25-49% of the time remains
- RED: 0-24% is indicated by Red

2. When the timer reaches zero, an audible alarm is triggered.

*NOTE: The timer stops when the door is opened and resumes when the door is closed.*

### LIGHT ACTIVATION

Press the LIGHT key to turn on the cavity lights. The icon turns yellow when activated. The key/relay will remain active until pressed again OR the 5 minute default timeout period is reached.

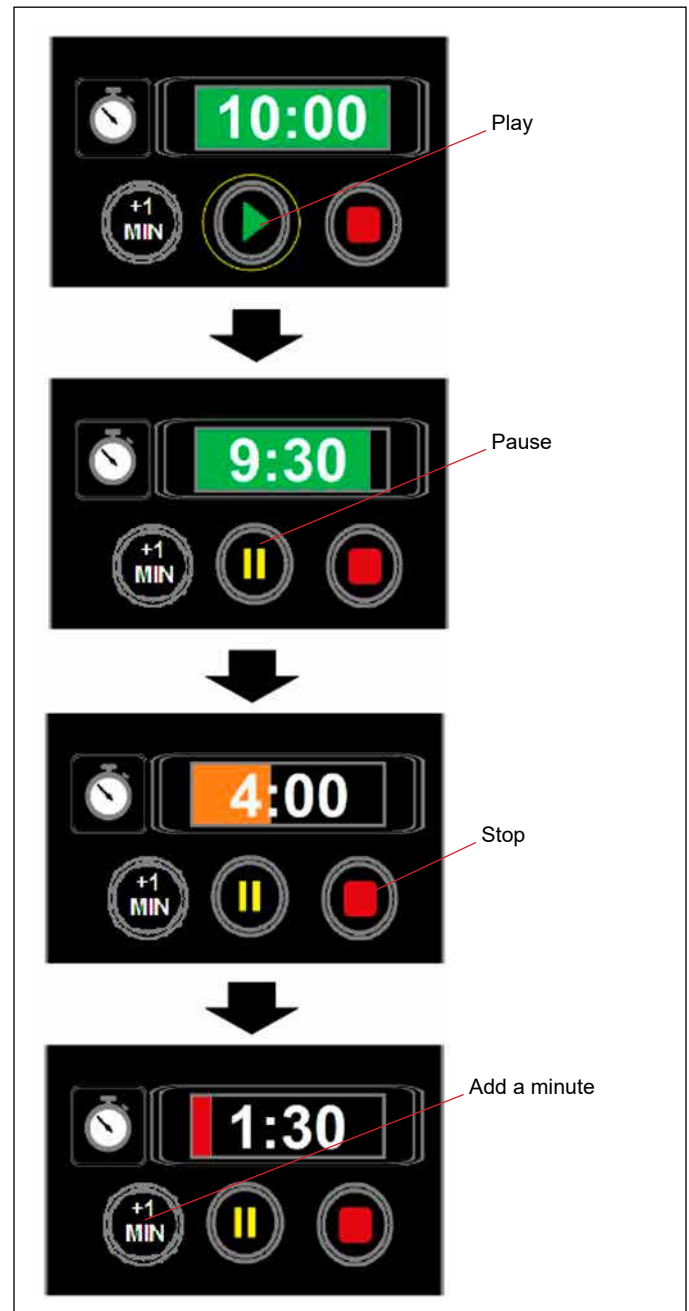

Figure 13

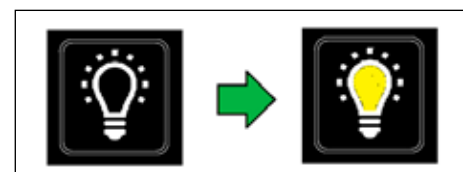

Figure 14



# Operation

## Simple Touch Control

### ADVANCED FUNCTIONS

#### Cook & Hold

The intent of Cook & Hold is to keep the product at a food safe temperature while not overcooking. Once the cook cycle is complete, the oven automatically switches to the hold time and temperature.

1. From the MANUAL COOK SCREEN, press the ADV. FUN icon.
2. Press the COOK & HOLD key. Four settings bars appear: cook temp, cook time, hold temp and hold time.
3. Use the keypad to enter desired cook and hold time and temperature settings.
4. Press the BACK key to return to the manual cook screen.
  - The C & H icon will replace the timer icon.
  - The timer bar will show the cumulative time of the cook and hold. The cook time will be shaded.
  - If the current set point differs from the Cook & Hold set point, it will change upon returning to the manual operation screen.
  - Press play to initiate Cook & Hold.
5. When the recipe is complete, the oven will maintain the Hold Temp until a new set temperature has been defined.

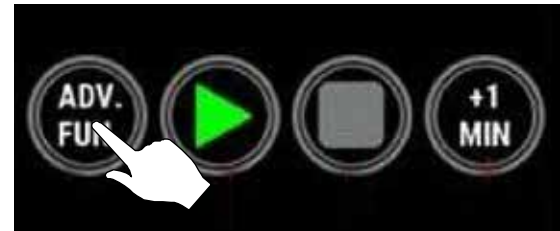

Figure 15

## Simple Touch Control

### Fan Pulse

1. From the MANUAL COOK SCREEN, press the ADV. FUN icon.
2. Press the FAN PULSE key.

The unit will cycle the fan on and off at the established fan speed over an established pulse duration. The default setting for the fan pulse duration is 30 seconds on / 30 seconds off.

*NOTE: When using fan pulse the oven will only be able to heat when fan is operating at set speed.*

3. Standard operation resumes when the fan pulse duration has elapsed.

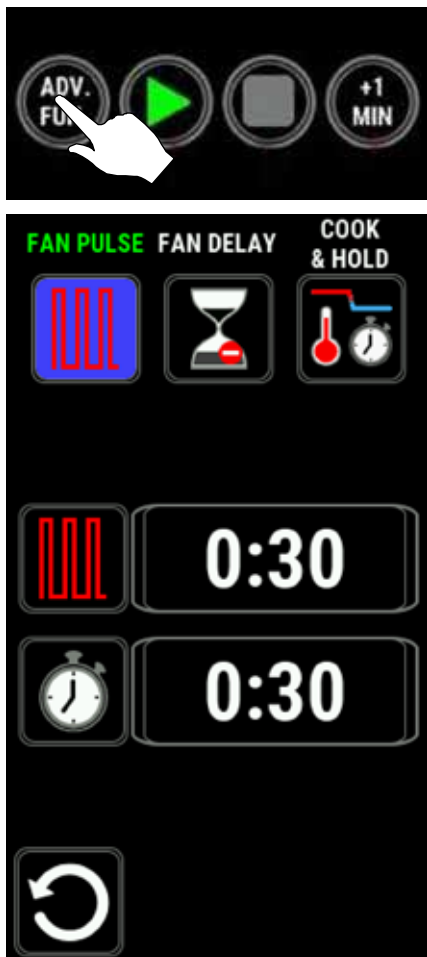

Figure 16

### Fan Delay

This feature delays the set fan speed to reduce pulling liquid batters at the beginning of the bake cycle. The fan resumes the set speed after the delay time has expired.

1. From the MANUAL COOK SCREEN, press the ADV. FUN icon.
2. Press the FAN DELAY key.

*NOTE: When using fan delay the oven will only be able to heat when fan is operating at set speed.*

3. Standard operation resumes when the fan delay duration has elapsed.

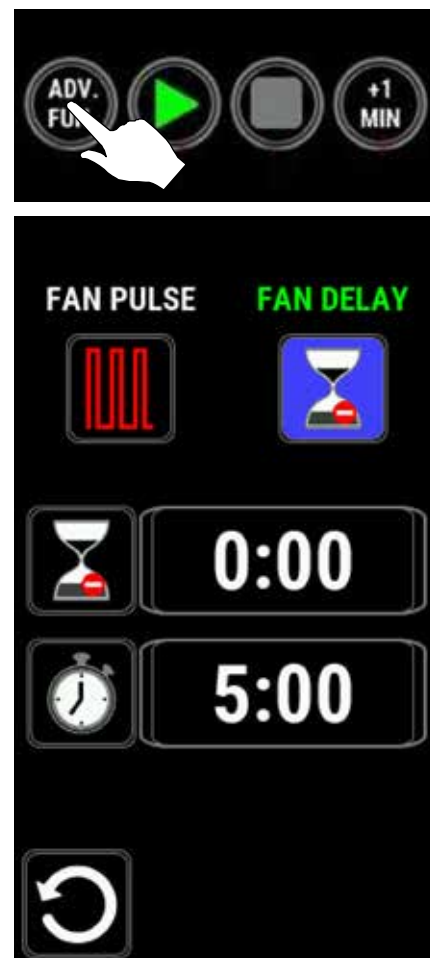

Figure 17



# Operation

## Simple Touch Control

### MENU MODE

Create a New Recipe

1. Press the service key icon, and then select the MAN-AGE RECIPES icon.

*NOTE: In the event of a lockout from MANAGE RE- CIPIES use passcode 6368.*



Figure 18

2. Select the Recipe Library icon.

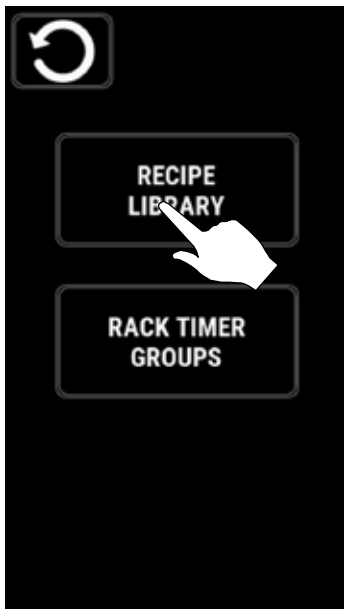

Figure 19

3. Select the ADD icon to add a new recipe



Figure 20

4. Name the recipe then press the green check mark.



Figure 21

## Simple Touch Control

- To enter the settings for the first cooking step, select the icon of the variable you wish to edit.

The icon of the selected variable will highlight in blue and the value in the currently selected stage will highlight in yellow.

- Use the knob to adjust the value.
  - Select the green check mark to confirm the selection.
- Press the + to add a step. Press the X to delete the selected step. Use the knob to scroll through recipe stages.
  - Select the disk icon to save the settings, and return to library menu.

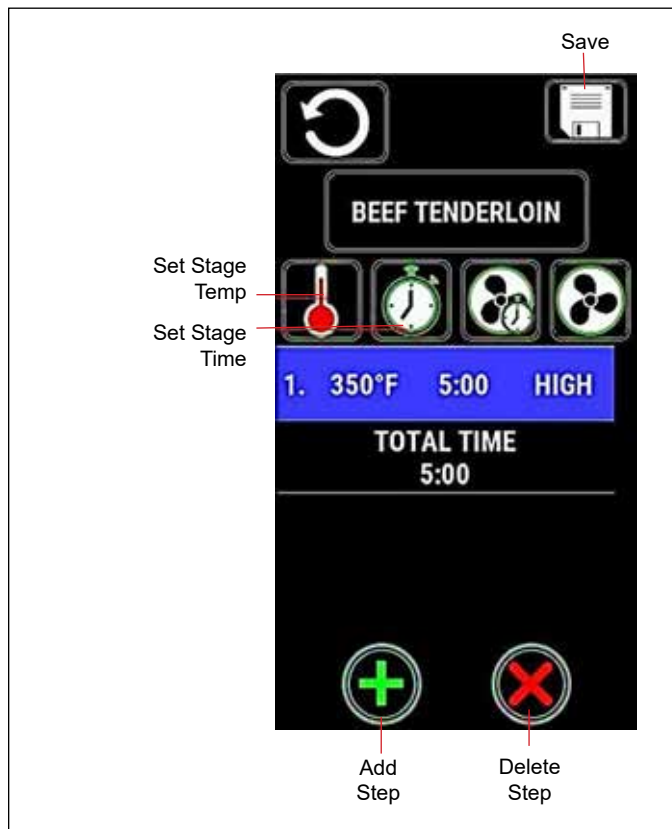

Figure 22

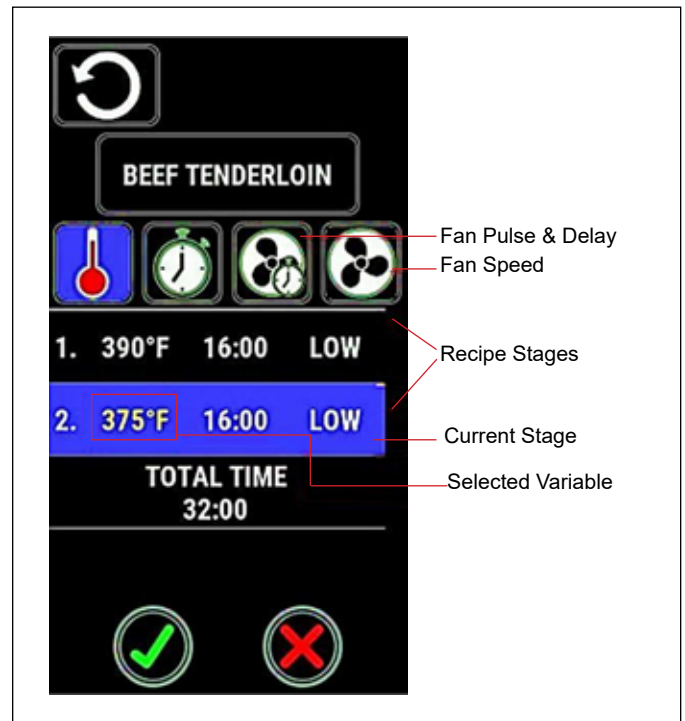

Figure 23

- To edit, copy or delete a recipe select the appropriate the icon called out below.

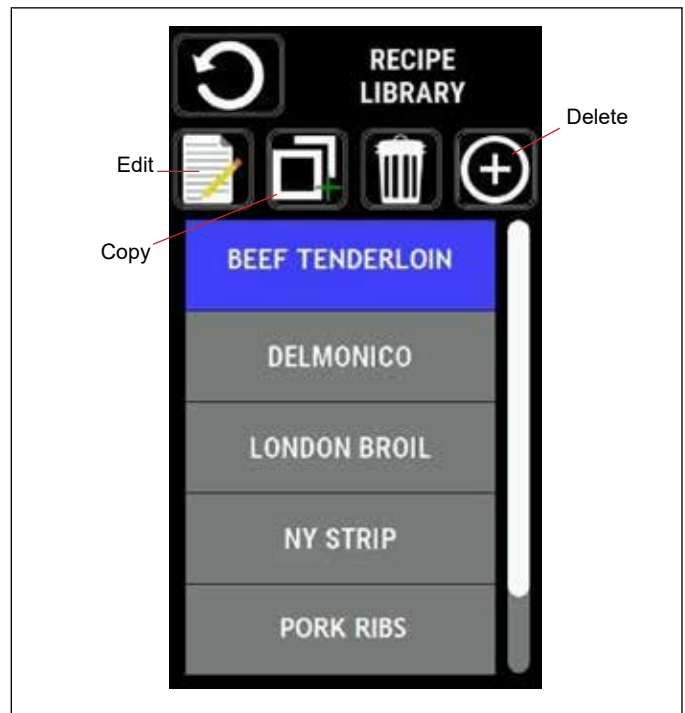

Figure 24





# Operation

## Simple Touch Control

### MENU MODE COOKING

1. Press the power key then select the RECIPE icon.

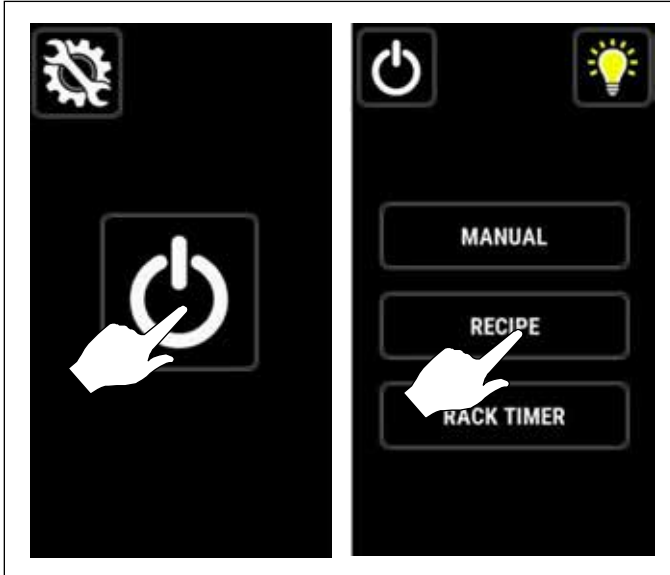

Figure 25

2. Use the knob to scroll through the listed recipes. Select the desired recipe.

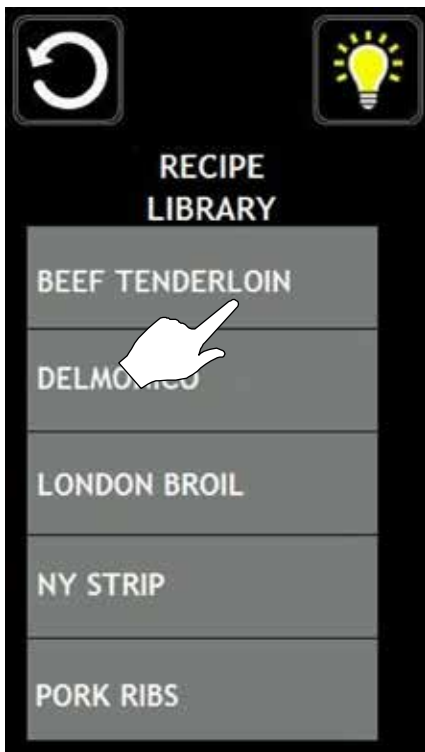

Figure 26

3. The control enters the Menu Cooking screen. Press the START ICON to begin the cook cycle.



*NOTE: If lockout is enabled START will not be selectable until the oven has reached the programmed set temperature.*

*NOTE: The settings between the blue lines indicate the current stage.*

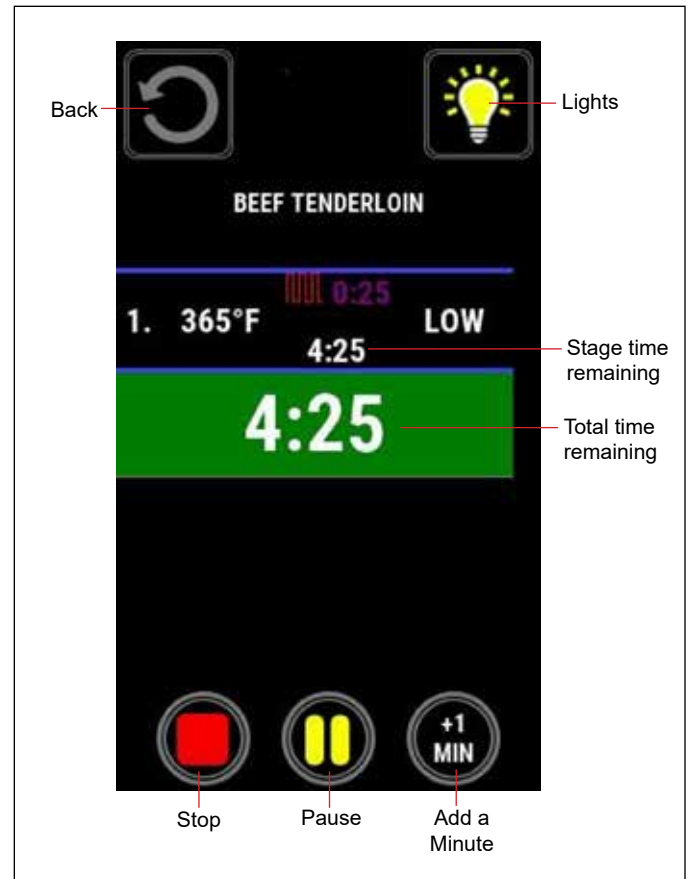

Figure 27

4. Add a Minute, pause and stop can be accessed at any time.
5. When the cook time has expired, the display flashes DONE and the alarm sounds. Press STOP to silence the alarm. The control returns to the recipe cook screen.
6. Press BACK to exit out of MENU mode.



## Simple Touch Control

### RACK TIMING

#### Creating a Rack Timing Group

1. Press the service icon, and then select the MANAGE RECIPES icon.

*NOTE: In the event of a lockout from MANAGE RECIPES use passcode 6368.*

2. Select RACK TIMER GROUPS. The RACK TIMER GROUPS screen is displayed.
3. Select ADD.
4. Use the keypad to name the group. Select the green check mark to save the name.

5. Select the recipes you would like to place in the group.

The first selected recipe will define the group parameters. Clicking a non-greyed recipe will associate it with the group. Only recipes with parameters matching the group may be selected. Recipes with parameters that fall outside group settings or have multiple stages will be greyed. Recipes associated to the group will have a check mark. Up to 12 recipes can be grouped.

6. Once you have finished selecting the recipes desired for your group, press save.



Figure 28



# Operation

## Simple Touch Control

### RACKTIMER COOKING

1. From the mode selection screen, select RACK TIMING. The RACK TIMER GROUPS screen is displayed.

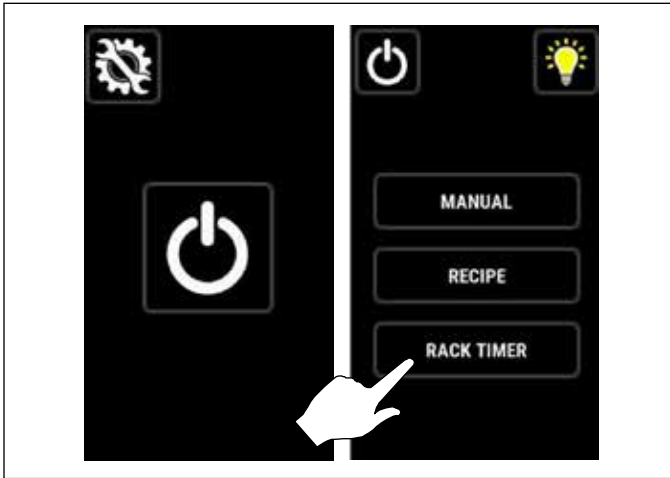

Figure 29

2. Select the desired recipe group. The preheat screen appears.

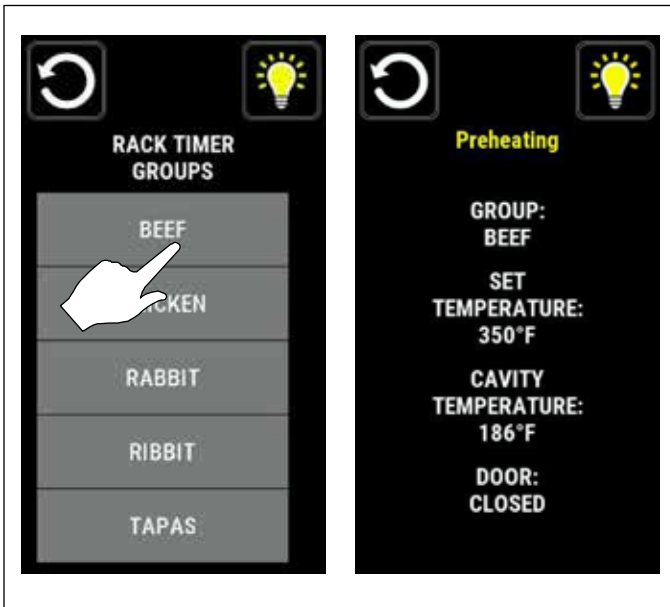

Figure 30

3. When the oven has preheated to the group set temp, the display changes to the RACK TIMING cook screen.

4. Turn the knob to cycle through the group recipes (left and right). The currently selected recipe is in highlighted in blue. The next available recipe in either direction is previewed in smaller recipe boxes to either side.
5. Select the area to the right of the rack number to assign currently highlighted recipe to that rack.

Start and cancel keys are to the right of timer bar when timer is inactive.

+1 min and stop keys are to the right of timer bar when timer is active or done.



Figure 31

### TO STORE AND LOAD MENU DATA TO A USB

**NOTE:** The following procedure may be used to store any type of data to a USB including HACCP, settings and fault logs.

**NOTE:** **Importing** - you will be given the option to select the desired recipe file on the USB drive. Once a recipe set has been selected you will be given the option to overwrite the existing recipe file with those on the USB or append them to the current recipe library.

**Exporting** – you will be prompted to name the recipe library being exported.

1. Press the SERVICE KEY.



Figure 32

2. Press the manager icon and enter passcode 6647.

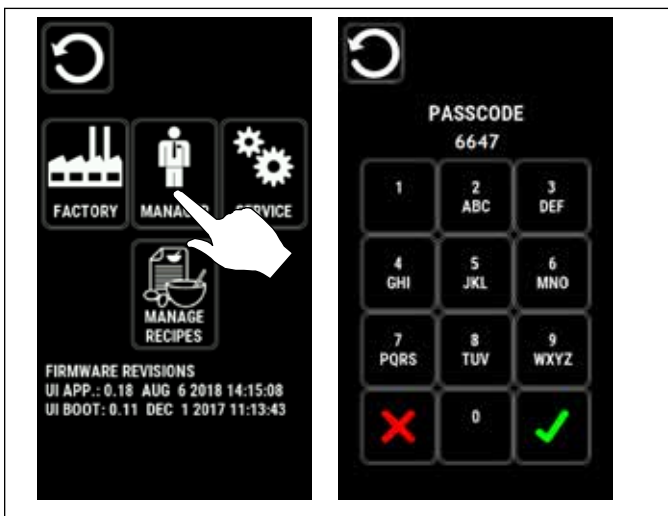

Figure 33

3. Select USB from the menu.

**NOTE:** The USB drive must be in the port.

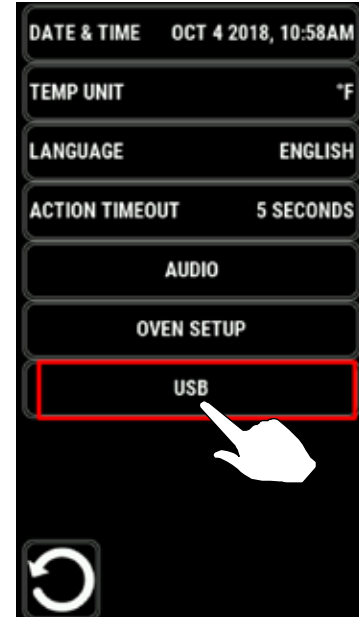

Figure 34

4. Select LOAD RECIPE FROM USB or STORE RECIPE TO USB, depending on the action you would like to complete.

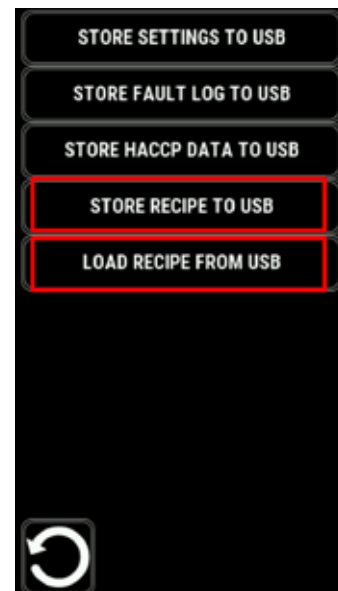

Figure 35



# Operation

## Simple Touch Control

- To load a recipe from the USB, select LOAD RECIPE FROM USB. Select the recipe file desired for download. The recipe file will highlight in blue when selected. When the selection is complete, press the green checkmark icon.

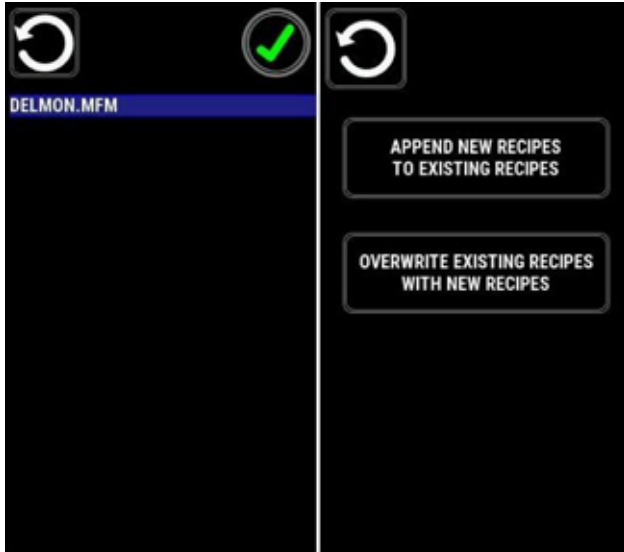

Figure 36

- Select the recipe(s) desired for download. When selected, the recipe(s) will have a blue checkmark next to it. When selection(s) are complete, press the SAVE TO USB icon.

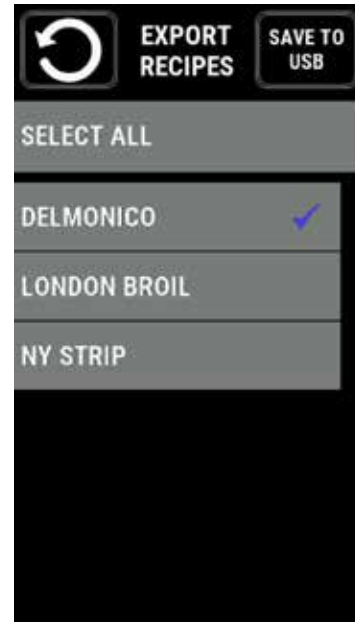

Figure 38

- To store recipe(s) to the USB, select STORE RECIPE TO USB. If desired, select the RACK TIMER groups you wish to export, when selected they will have a blue check mark. Then select CONTINUE TO RECIPES.



Figure 37

- Create a name for the recipe file. When complete, press the green checkmark icon.



Figure 39

### COOL DOWN

1. Press the POWER KEY. The display will ask if you would like to cool down prior to shut down.

**If the green check mark is selected** - the display changes to a power screen with a prompt to have the door open. The control also displays the current cavity temperature.

The fan runs in high speed. When the cool down temperature is reached an alarm sounds and the cavity temperature and door message are removed. All functions will cease as in standard shut down.

**If the red X is selected** - the display immediately returns to the standard power screen and all functions cease.

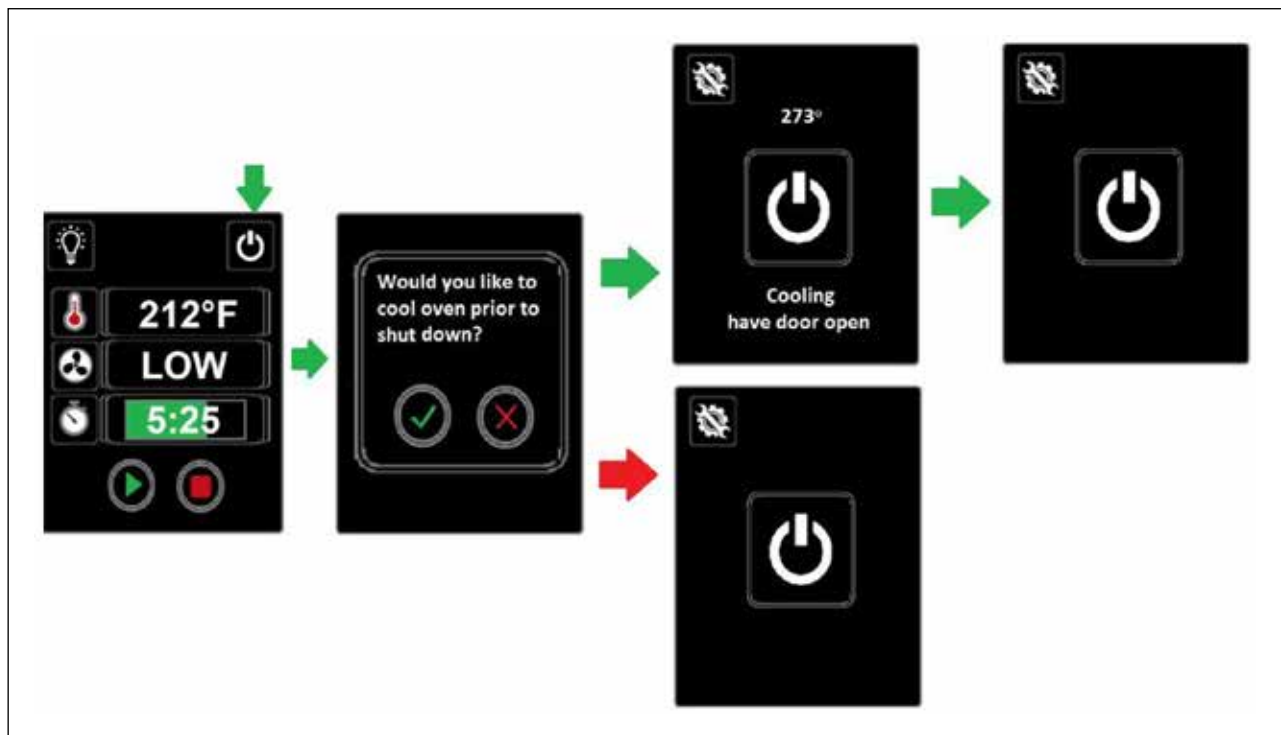
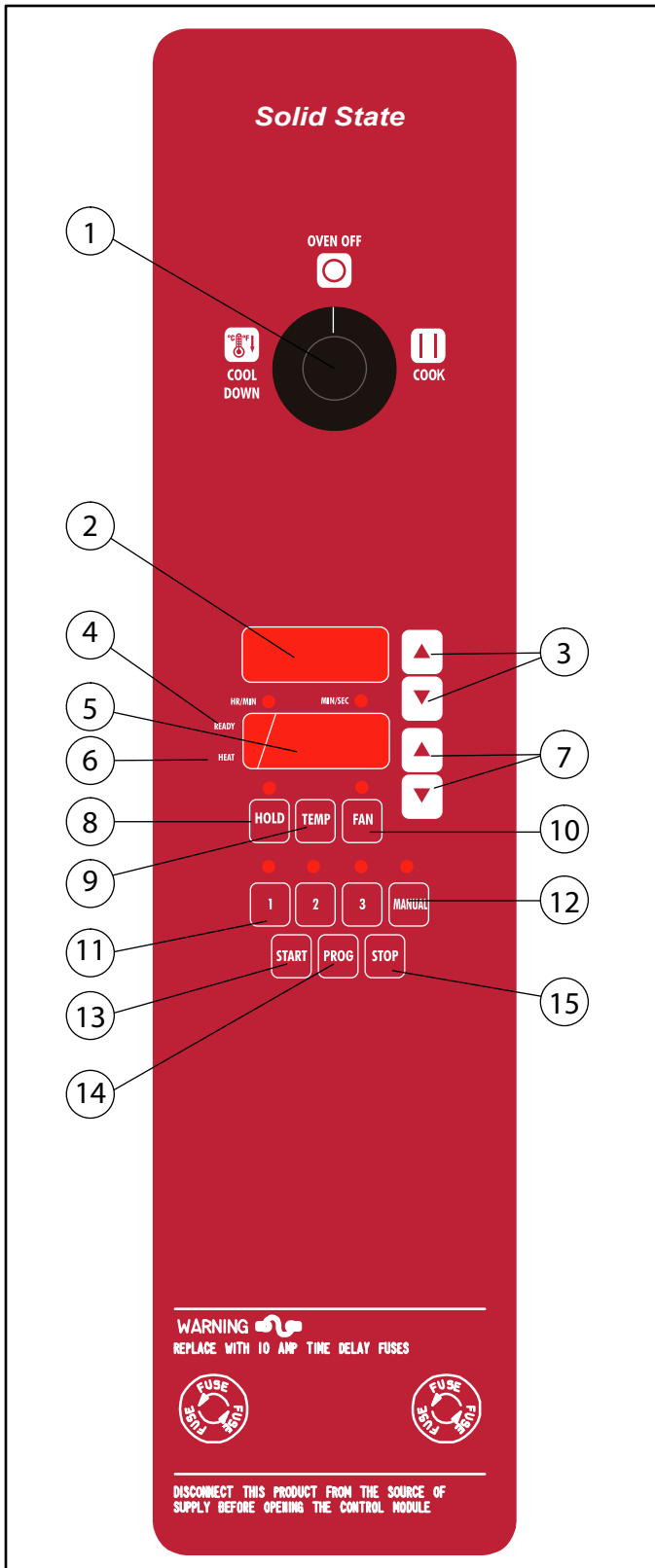

Figure 40



# Operation

## CH-Pro3 (Solid State Programmable Digital Control)



### COMPONENT DESCRIPTION

1. SELECTOR SWITCH - turns power to the oven on or off. Allows selection of cook or cool down modes and fan speed (if applicable).
2. TIME DISPLAY - gives cook time.
3. TIME ARROW KEYS - press to enter cook and/or pulse times.
4. READY INDICATOR - when lit indicates the oven has reached the setpoint temperature and product may be loaded.
5. TEMPERATURE DISPLAY - gives cook and hold temperatures.
6. HEAT INDICATOR - when lit indicates the oven is heating.
7. TEMPERATURE ARROW KEYS - press to enter cook and hold temperatures.
8. HOLD KEY - turns hold mode on or off.
9. TEMP KEY - press to display actual oven temperature.
10. FAN KEY - turns pulse mode on or off. The LED above the fan key is always on.
11. PRODUCT KEYS - three programmable keys.
12. MANUAL PRODUCT KEY - default product key used for manual operation.
13. START KEY - press to begin a cook cycle.
14. PROGRAM KEY - press to enter programming mode and save programmed settings.
15. STOP KEY - press to silence audible alarms and cancel cook cycles.

Figure 41

## CH-Pro3 (Solid State Programmable Digital Control)

### MANUAL OPERATION

*NOTE: Press the arrow keys to change the cook time and temperature at any point during manual operation.*

#### Cook Only:

1. Turn the SELECTOR SWITCH (1) to the desired position.
2. Press the MANUAL PRODUCT KEY (12). The manual and fan key LEDs light.
3. Press the TIME ARROW KEYS (3) to enter the cook time.
4. Press the TEMPERATURE ARROW KEYS (7) to enter the cook temperature.
5. The READY INDICATOR (4) lights when the oven is at the set temperature. Load product into the oven.
6. Press the START KEY (13). The TIME DISPLAY (2) counts down. The manual key LED flashes.
7. When the cook time expires the LEDs and both displays flash and an audible alarm sounds. Press the STOP KEY (15) to silence the alarm.
8. Remove the product.

#### Cook with Hold:

1. Turn the SELECTOR SWITCH (1) to the desired position.
2. Press the MANUAL PRODUCT KEY (12). The manual and fan key LEDs light.
3. Press the TIME ARROW KEYS (3) to enter the cook time.
4. Press the TEMPERATURE ARROW KEYS (7) to enter the cook temperature.
5. Press and hold the HOLD KEY (8). At the same time use the TEMPERATURE ARROW KEYS (7) to enter the hold temperature. The hold key LED lights.
6. The READY INDICATOR (4) lights when the oven is at the set temperature. Load product into the oven.
7. Press the START KEY (13). The TIME DISPLAY (2) counts down. The manual key LED flashes.

8. When the cook time expires both displays flash and an audible alarm sounds for several seconds then self cancels. The hold key LED flashes. The time display begins to count up while the oven cools to the hold temperature. When the oven reaches the hold temperature the time display resets to 00:00 then begins to count up the hold time. The fan cycles with heat demand in the hold mode.
9. Press the STOP KEY (15) to stop the timer.
10. Remove the product.
11. Push the HOLD KEY (8) to turn off hold mode.

#### Cook with Pulse:

1. Turn the SELECTOR SWITCH (1) to the desired position.
2. Press the MANUAL PRODUCT KEY (12). The manual and fan key LEDs light.
3. Press the TEMPERATURE ARROW KEYS (7) to enter the cook temperature.
4. Press the FAN KEY (10). The fan key LED flashes. Use the TIME ARROW KEYS (3) to enter the pulse time.
5. The READY INDICATOR (4) lights when the oven is at the set temperature. Load product into the oven.
6. Press the START KEY (13). The manual key LED flashes. The TIME DISPLAY (2) counts down. The fan cycles on for 30 seconds then off for 30 seconds until the set pulse time has expired.
7. When the pulse time expires both displays flash and an audible alarm sounds. Press the STOP KEY (15) to silence the alarm.
8. Remove the product.

#### Oven Shut Down:

1. Turn the SELECTOR SWITCH (1) to OVEN OFF.





# Operation

## CH-Pro3 (Solid State Programmable Digital Control)

### PROGRAMMING THE MANUAL KEY DEFAULT

1. Turn the SELECTOR SWITCH (1) to the desired position.
2. Press the MANUAL KEY (12). The manual and fan key LEDs light.
3. Press the PROGRAM KEY (14).
4. Press the TIME ARROW KEYS (3) to enter the cook time.
5. Press the TEMPERATURE ARROW KEYS (7) to enter the cook temperature.
6. **For Cook and Hold** - Press and hold the HOLD KEY (8). At the same time use the TEMPERATURE ARROW KEYS (7) to enter the hold temperature. The hold key LED lights.  
**For Cook with Pulse** - Press the FAN KEY (10). Use the TIME ARROW KEYS (3) to enter the pulse time. The fan key LED flashes.
7. Press the PROGRAM KEY (14) to save the program settings.

### MANUAL KEY DEFAULT OPERATION

1. Turn the SELECTOR SWITCH (1) to the desired position.
2. Press the MANUAL KEY (12). The applicable LEDs light.
3. Press the START KEY (13). The TIME DISPLAY (2) counts down. The manual key LED flashes.

*NOTE: In Cook with Pulse the fan LED flashes.*

*NOTE: Press the arrow keys to change the cook time and temperature at any point during manual key operation.*

4. When the cook time expires the applicable LEDs and both displays flash and an audible alarm sounds.
5. Press the STOP KEY (15) to silence the alarm.  
*NOTE: In Cook & Hold the alarm self cancels. The oven cools to the hold temperature and the time display counts up.*
6. Remove the product.
7. Turn the SELECTOR SWITCH (1) to OFF to shut down the oven.

### PROGRAMMING THE PRODUCT KEYS

1. Turn the SELECTOR SWITCH (1) to the desired position.
2. Press the desired PRODUCT KEY (11). The product and fan key LEDs light.
3. Press and hold the PROGRAM KEY (14) until the corresponding LED flashes, approximately five seconds.
4. Press the TIME ARROW KEYS (3) to enter the cook time.
5. Press the TEMPERATURE ARROW KEYS (7) to enter the cook temperature.
6. **For Cook and Hold** - Press and hold the HOLD KEY (8). At the same time use the TEMPERATURE ARROW KEYS (7) to enter the hold temperature. The hold key LED lights.  
**For Cook with Pulse** - Press the FAN KEY (10). Use the TIME ARROW KEYS (3) to enter the pulse time. The fan key LED flashes.
7. Press the PROGRAM KEY (14) to save the program settings.

### PRODUCT KEY OPERATION

1. Turn the SELECTOR SWITCH (1) to the desired position.
2. Press the desired PRODUCT KEY (11). The applicable LEDs light.
3. Press the START KEY (13). The TIME DISPLAY (2) counts down. The product key LED flashes.

*NOTE: In Cook with Pulse the fan LED flashes.*

4. When the cook or pulse time expires the applicable LEDs and both displays flash and an audible alarm sounds.
5. Press the STOP KEY (15) to silence the alarm.  
*NOTE: In Cook and Hold the alarm self cancels. The oven cools to the hold temperature and the time display counts up.*
6. Remove the product.
7. Turn the SELECTOR SWITCH (1) to OFF to shut down the oven.



## Blodgett IQ2™ Vision Control

### COMPONENT DESCRIPTION

1. OVEN POWER SWITCH - controls power to the oven.
2. DISPLAY - displays temperature and other controller related information.
3. PROGRAM KEY - press to enter the programming mode.
4. PROGRAM ARROW KEYS - use to move through programming menus and options
5. HEAT LED - when lit indicates the control is calling for heat.
6. PROG LED - when lit indicates the controller is in the programming mode.
7. HIGH FAN LED - when lit indicates the fan is running at high speed.
8. LOW FAN LED - when lit indicates the fan is running at low speed.
9. SCAN KEY - Press to view time remaining on multiple cook cycles and to review recipe programming.
10. COOL DOWN KEY - press to enter the cool down mode.
11. TEMP/TOGGLE/CLEAR KEY - press during programming to toggle options.
12. HOLD KEY - press to enter hold mode.
13. SET BACK KEY -
14. PRODUCT KEYS (1-10) - assigns a key to a programmed recipe and begins a programmed cooking process. Also used to enter numeric values in the programming mode.
15. PRODUCT LEDS - when lit indicate which product keys are currently in use or programmed for the current oven temperature and fan speed.
16. SHELF KEYS (1-5) - assigns a shelf key.

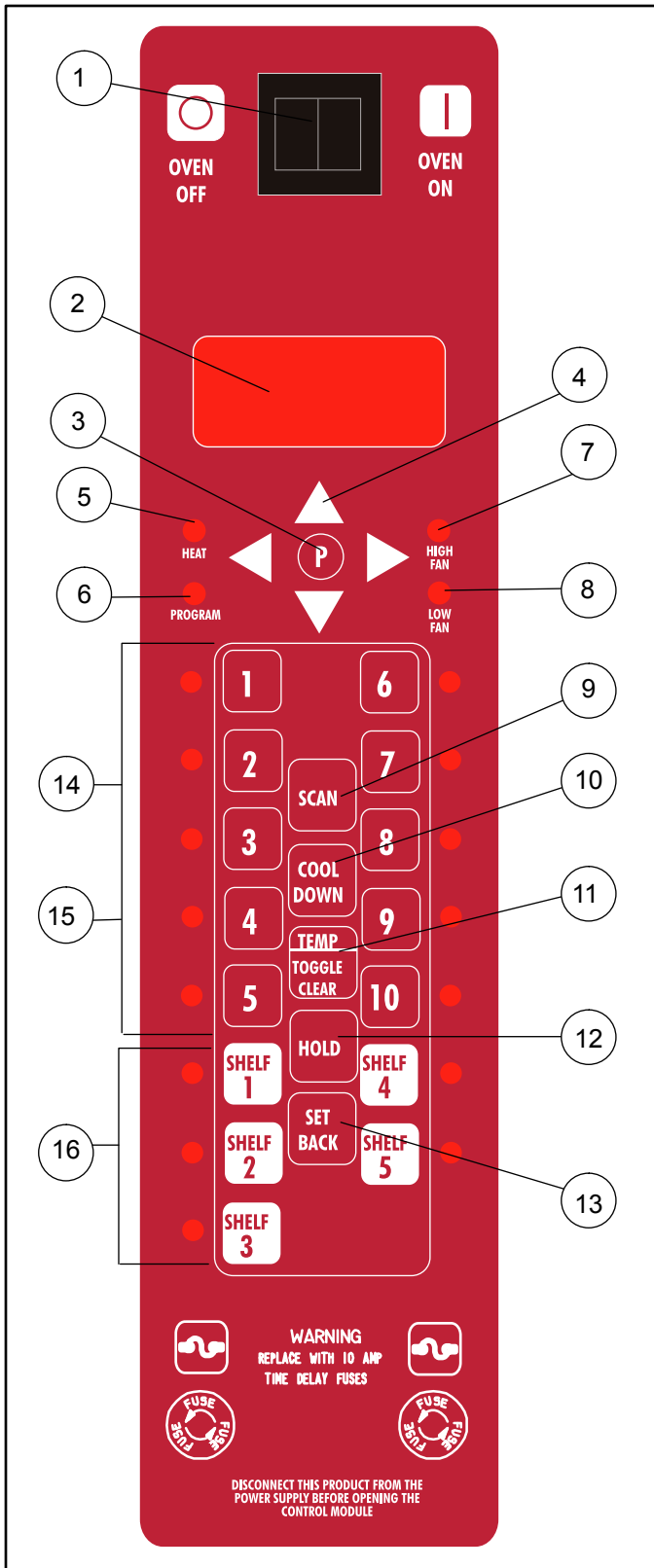

Figure 42



# Operation

## Blodgett IQ2™ Vision Control

### OVEN OPERATION

#### Oven Startup:

1. Toggle the POWER SWITCH (1) to ON. The display gives the software revision level. The oven preheats to the lowest programmed first stage temperature. The LEDS (15) for all products with the same first stage temperature light.

#### Single Product Cooking Procedure:

*NOTE: If the led next to the desired product key is lit skip step 1.*

1. Press the desired PRODUCT KEY (14). The oven preheats to the first stage temperature for the selected product. When the oven reaches 10° of the preheat temperature an alarm sounds and the DISPLAY (2) read:

LOAD

2. Load the product into the oven. Press the desired PRODUCT KEY (14).
3. **If the shelf timing function is toggled to the on position for that product key**, the DISPLAY (2) reads:

PICK SHLF

Press a SHELF KEY (16) to assign the product to that shelf and start the cook cycle. Within five seconds, the DISPLAY (2) scrolls the product name and shelf number and counts down the remaining cook time.

**If the shelf timing function is toggled to the off position for that product**, pressing the product key will start the cook cycle. The DISPLAY (2) scrolls the product name and counts down the remaining cook time.

*NOTE: If the selected product has a cook time of greater than 59:59 the DISPLAY (2) switches to hours:minutes.*

*NOTE: If the selected product is a single stage recipe the LEDS for all single stage products with the same cook temperature and fan speed will light. If the selected product is a multiple stage recipe no other product LEDS will light.*

*NOTE: Press and hold the selected product key for*

*three seconds to cancel the cook cycle for normal operation. To cancel the cook cycle when using shelf timing, press and hold the corresponding SHELF KEY (16) for 3 seconds.*

4. When the cook time expires an alarm sounds and the DISPLAY (2) reads:

DONE  
Product name

5. Press the selected product key to silence the alarm. Remove the product. If shelf timing is used, press the flashing SHELF KEY (16) to silence the alarm.

#### Multiple Batch Cooking Procedure:

This procedure is for single stage recipes with the same cook temperature and fan speed only.

*NOTE: If the led next to the first desired product key is lit skip step 1.*

1. Press the first desired PRODUCT KEY (14). The LEDS for all recipes with the same cook temperature and fan speed will light.

The oven preheats to the cook temperature for the selected product. When the oven reaches ±10° of the preheat temperature an alarm sounds and the DISPLAY (2) reads:

LOAD

## Blodgett IQ2™ Vision Control

2. Load the product into the oven. Press the desired PRODUCT KEY (14).

If the shelf timing function is toggled to the on position for that product key, the DISPLAY (2) reads

PICK SHLF

Press a SHELF KEY (16) to assign the product to that shelf and start the cook cycle. Within five seconds, the DISPLAY (2) scrolls the product name and shelf number and counts down the remaining cook time.

If the shelf timing function is toggled to the off position for that product, pressing the product key will start the cook cycle. The DISPLAY (2) scrolls the product name and counts down the remaining cook time.

3. Load the second product. Press the desired PRODUCT KEY (14). the DISPLAY (2) reads

PICK SHLF

Press a SHELF KEY (16) to assign the product to that shelf and start the cook cycle for product two.

*NOTE: Only products with lighted LEDS may be selected.*

Repeat step 3 for additional products.

4. The DISPLAY (2) scrolls the product name and counts down the remaining cook time for the product with the least time remaining.

*NOTE: To view the remaining cook time for the other products press and hold the SCAN KEY (9). The display cycles through the remaining cook times for each product. Only the led for the product with the cook time displayed will be lit.*

5. When a cook time expires an alarm sounds. The display reads

DONE

The led for the finished product lights. All other LEDS are dark.

6. Press the SHELF KEY (16) for the finished product to silence the alarm. Remove the product. Close the oven door. The DISPLAY (2) scrolls the product name and counts down the remaining cook time for the product with the least time remaining.

7. When the cook time expires an alarm sounds and the display reads:

DONE

8. Press the SHELF KEY (16) to silence the alarm. Remove the product.

### Oven Cool Down:

1. Close the oven door. Press the COOL DOWN KEY (10).

*NOTE: Cool down cannot be activated with the oven door open. Once the cool down cycle has begun the doors may be opened to speed the cooling process.*

### To Review Repipe Programming:

1. Press the SCAN KEY (9). The display reads:

RECIPE REVIEW  
Select Product

The LEDS (15) for all previously programmed product keys light. Press the PRODUCT KEY (14) you wish to review. The display gives the recipe cook time for stage 1. Use the PROGRAM ARROW KEYS (4) to scroll through the recipe programming for the selected product key.

2. The control will exit recipe review after 30 seconds if no key is pressed.



# Operation

## Blodgett IQ2™ Vision Control

### PRODUCT KEY PROGRAMMING

#### To enter the product programming mode

1. Press and hold the PROGRAM KEY (3). The DISPLAY (2) reads:

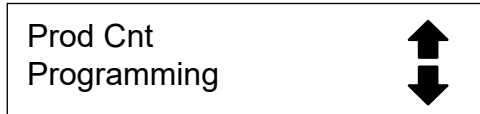

Use the PROGRAM ARROW KEYS (4) to highlight Programming. Press the PROGRAM KEY (3) to select. The display reads:

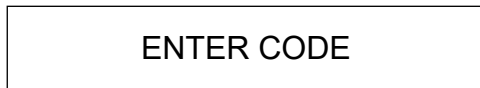

Use the PRODUCT KEYS (14) to enter the programming access code 1724. Press the PROGRAM KEY (3). The display reads:



Press the PROGRAM KEY (3). All of the product LEDs will light and the display reads:

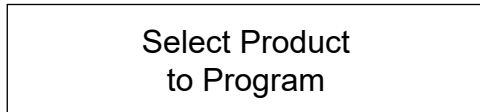

#### To select the product to program

2. Press the desired product key. The display reads:



With All highlighted, press the PROGRAM KEY (3). The display reads:

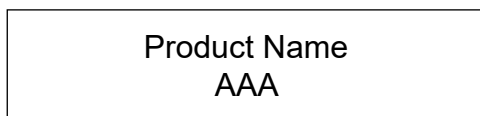

The first alphabetical listing in the product name library appears.

3. To change the product name, use the PROGRAM ARROW KEYS (4) to scroll through the product name library. When the desired product name is highlighted, press the PROGRAM KEY (3) to select.

#### To program the product

4. The display reads:

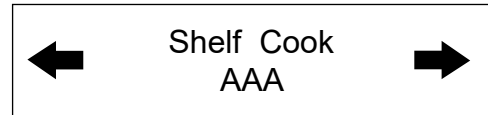

**Definition:** Shelf cook enables the operator to reference product to one of the five shelf positions in the oven. At the end of a shelf cooking cycle the oven will display the name of the product and the shelf number that is ready to be pulled. **Shelf cooking is not available for multi-stage recipes.**

Use non shelf cooking when you do not need to reference product to one of the five shelf positions in the oven. Non shelf cooking may be used for single stage recipes and **MUST be use for multi-stage recipes.**

Use the PROGRAM ARROW KEYS (4) to select either YES (for shelf cooking) or NO (for non shelf cooking). Press the PROGRAM KEY (3).

5. The display reads:

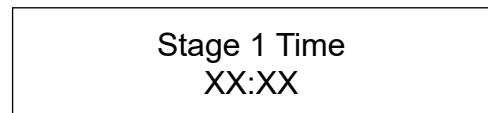

Use the PRODUCT KEYS (14) to enter the desired cook time. Press the PROGRAM KEY (3).

6. The display reads:

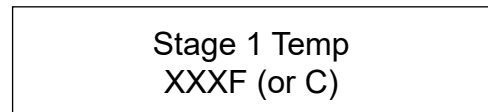

Use the PRODUCT KEYS (14) to enter the desired cook temperature. Press the PROGRAM KEY (3).

## Blodgett IQ2™ Vision Control

7. The display reads:

Stage 1 Timing  
XX:XX

**Definition:** There are 3 options for timing mode when shelf cooking: Straight, Flex and Sensitivity. Straight has no time adjustment. Flex adjusts the cook time to compensate for any difference between the setpoint and actual temperature. Sensitivity enables a product key to have a flex adjustment for each of the five shelves. Sensitivity values are set in the manager level programming.

*NOTE: Sensitivity is only available when using shelf cooking.*

Use the PROGRAM ARROW KEYS (4) to select the desired timing mode. Press the PROGRAM KEY (3).

8. The display reads:

← Stage 1 Fan Speed →  
XX

Use the PROGRAM ARROW KEYS (4) to select either HIGH or LOW fan speed. Press the PROGRAM KEY (3).

9. The display reads:

← Stage 1 Fan Cyc →  
XXX

**Definition:** There are 3 options for fan cycle time: Pulse, Heat and Full. Pulse allows the fan to turn on and off as programmed. Heat allows the fan to operate with heat only. Full provides continuous fan operation when door is closed.

Use the PROGRAM ARROW KEYS (4) to select the fan cycle. If heat or full are selected skip to step 10. If pulse is selected the display reads:

Stage 1 Fan On  
XX:XX

Use the PRODUCT KEYS (14) to enter the desired length of the time the fan should be on in the pulse cycle. Press PROGRAM KEY (3). The display reads:

Stage 1 Fan Off  
XX:XX

Use the PRODUCT KEYS (14) to enter the desired length of the time the fan should be off in the pulse cycle. Press the PROGRAM KEY (3).

10. If you are programming a product using shelf cooking skip to step 11.

If you are programming a product that does not use shelf cooking the display reads:

Stage 2 Time  
XX:XX

Repeat steps 5 through 10 for each remaining stage. If you are programming a single stage recipe without shelf cooking enter at time of 00:00 for stage 2.

11. The display reads:

Alarm 1 Time  
XX:XX

**Definition:** If you would like the alarm to sound prior to the completion of the cook cycle you may program it here. The alarm time counts up from the beginning of the cook cycle. For example, if you want an alarm 9 minutes into the cook cycle, program the alarm time at 9:00.

Use the PRODUCT KEYS (14) to enter the time for the first alarm to sound. If 00:00 is entered for an alarm time, skip to step 12.

Press the PROGRAM KEY (3). If a time other than 00:00 is entered the display reads:



# Operation

## Blodgett IQ2™ Vision Control

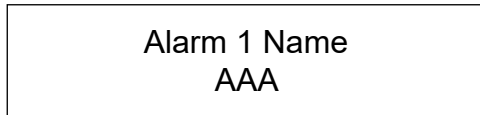

To change the alarm name, use the PROGRAM ARROW KEYS (4) to scroll through the alarm name library.

Press the PROGRAM KEY (3). The display reads:

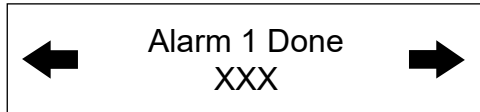

Use the PROGRAM ARROW KEYS (4) to select either AUTOMATIC or MANUAL.

Press the PROGRAM KEY (3). The display reads:

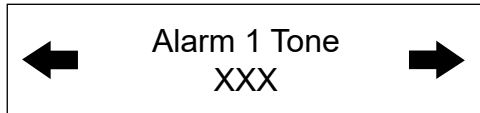

Use the PROGRAM ARROW KEYS (4) to select either NONE, SHORT, MEDIUM, LONG, DOUBLE, or LONG/SHORT.

Press the PROGRAM KEY (3). The display reads:

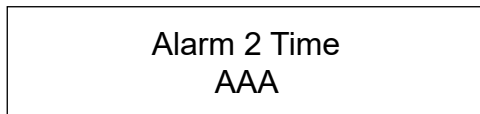

Repeat step 11 for alarm 2. If no Alarm 2 is desired, enter a time of 0.

12. Press the PROGRAM KEY (3). The display reads:

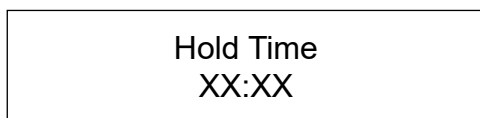

Use the PRODUCT KEYS (14) to enter desired hold time. If a hold time of 00:00 is entered skip to step 13.

Press the PROGRAM KEY (3).

13. The display reads:



Use the PRODUCT KEYS (14) to enter desired hold temperature. The minimum hold temperature is 140F. Press the PROGRAM KEY (3).

14. The display reads:

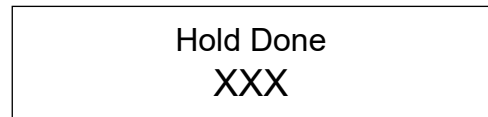

Use the PROGRAM ARROW KEYS (4) to select either AUTOMATIC or MANUAL. Press the PROGRAM KEY (3).

15. The display reads:



Use the PROGRAM ARROW KEYS (4) to select HIGH or LOW. Press the PROGRAM KEY (3).

### To exit the program mode

16. The display reads:



Use the PROGRAM ARROW KEYS (4) to scroll down until exit is highlighted. Press the PROGRAM KEY (3). The display reads:



To program another product key select recipe. To exit the program mode select exit. The display reads:

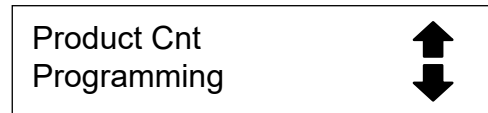

Use the PROGRAM ARROW KEYS (4) to scroll down until exit is highlighted. Press the PROGRAM KEY (3) to exit the programming mode.



### SYSTEM LEVEL PROGRAMMING

#### Entering the system programming mode

1. Press and hold the PROGRAM KEY (3). The display reads:

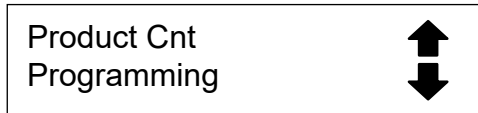

Use the PROGRAM ARROW KEYS (4) to highlight Programming. Press the PROGRAM KEY (3) to select. The display reads:

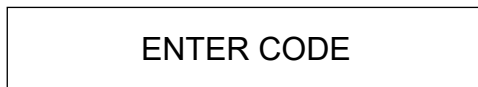

Use the PRODUCT KEYS (14) to enter the programming access code 6647. Press the PROGRAM KEY (3). The display reads:



#### Programming the SYSTEM options

1. With System highlighted, press the PROGRAM KEY (3) to select. The display reads:

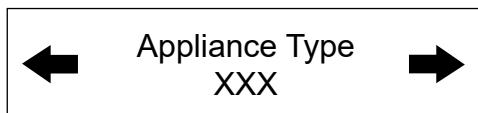

Use the PROGRAM ARROW KEYS (4) to highlight electric half, electric full, gas half or gas full. Press the PROGRAM KEY (3) to select the correct appliance type.

If the appliance type is changed the display scrolls "Are you sure, existing recipes will be cleared?" Use the PROGRAM ARROW KEYS (4) to select either YES or NO.

2. The display reads:

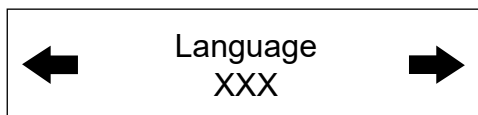

Use the PROGRAM ARROW KEYS (4) to select either English or Other. Press the PROGRAM KEY (3) to select the desired language.

3. The display reads:

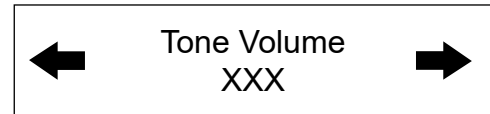

Use the PROGRAM ARROW KEYS (4) to select None, 1, 2, 3 or 4. Press the PROGRAM KEY (3) to select the desired level for all audible signals.

4. The display reads:

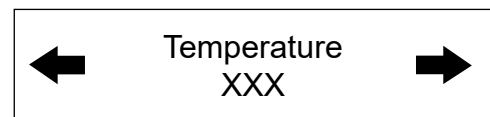

Use the PROGRAM ARROW KEYS (4) to select either F or C. Press the PROGRAM KEY (3) to select the desired temperature units.

5. The display reads:

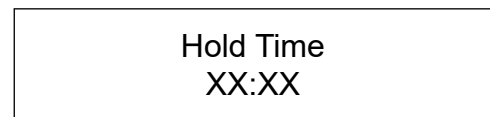

Use the PRODUCT KEYS (14) to enter a hold time. Press the PROGRAM KEY (3).

6. The display reads:

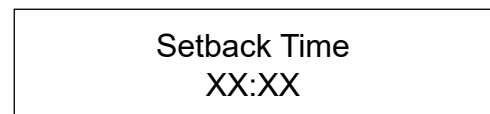

**Definition:** Setback time is an energy savings feature that automatically lowers the cavity temperature when the oven is idle.

Use the PRODUCT KEYS (14) to enter a setback time. Press the PROGRAM KEY (3).

7. The display reads:







# Operation

## Blodgett IQ2™ Vision Control

**Definition:** If you are using sensitivity as a timing mode for single stage stage recipes this feature must be turned on.

Use the PROGRAM ARROW KEYS (4) to select either Yes or No. Press the PROGRAM KEY (3).

8. The display reads:

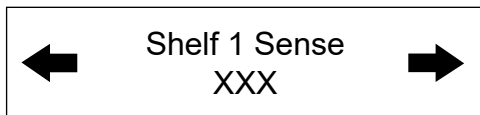

Use the PRODUCT KEYS (14) to enter sensitivity level of 1-9 for shelf 1. Press the PROGRAM KEY (3). Repeat for shelves 2-5.

9. The display reads:

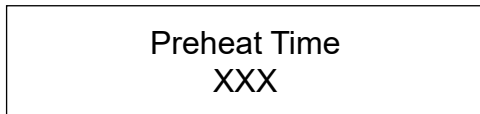

**Definition:** This function programs time for the oven to idle after reaching the preheat temperature allowing heat to saturate the oven cavity. The preheat time only applies to the initial preheat after a cold start. This is strictly a prompt, the user may begin a bake cycle even with the preheat prompt displayed.

Use the PRODUCT KEYS (14) to enter a preheat time. Press the PROGRAM KEY (3).

10. The display reads:



Use the PROGRAM ARROW KEYS (4) to select either Yes or No. Press the PROGRAM KEY (3).

11. The display reads:

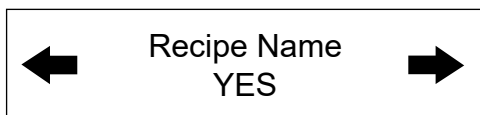

This enables you to program a product name. Use the PROGRAM ARROW KEYS (4) to select either Yes or No. Press the PROGRAM KEY (3).

12. The display reads:

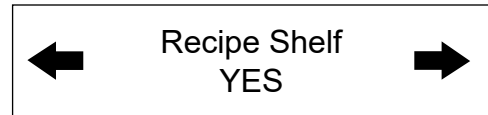

Use the PROGRAM ARROW KEYS (4) to select either Yes or No. Press the PROGRAM KEY (3).

13. The display reads:

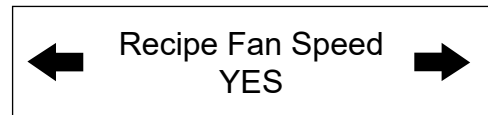

Use the PROGRAM ARROW KEYS (4) to select either Yes or No. Press the PROGRAM KEY (3).

14. The display reads:

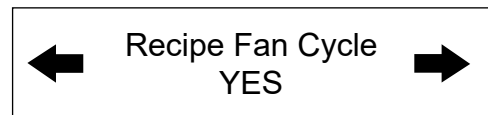

Use the PROGRAM ARROW KEYS (4) to select either Yes or No. Press the PROGRAM KEY (3).

15. The display reads:

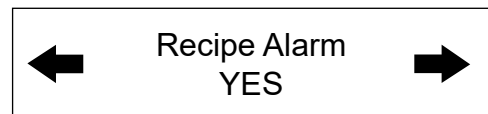

Use the PROGRAM ARROW KEYS (4) to select either Yes or No. Press the PROGRAM KEY (3).

16. The display reads:



Use the PROGRAM ARROW KEYS (4) to select either Yes or No. Press the PROGRAM KEY (3).



## Blodgett IQ2™ Vision Control

17. The display reads:



Use the PROGRAM ARROW KEYS (4) to select either Yes or No. Press the PROGRAM KEY (3).

18. The display reads



**Definition:** There are 3 options for timing mode when shelf cooking: Straight, Flex and Sensitivity. Straight has no time adjustment. Flex adjusts the cook time to compensate for any difference between the setpoint and actual temperature. Sensitivity enables a product key to have a flex adjustment for each of the five shelves. Sensitivity values are set in the manager level programming.

Use the PROGRAM ARROW KEYS (4) to select the timing mode. Press the PROGRAM KEY (3).

### Programming the PRODUCT NAME

*NOTE: Use these instructions to modify an existing name, to add a product name or to delete a name already in the library.*

*NOTE: Names may be up to 16 characters long and can contain letters and numbers.*

1. After entering the manager level programming (see page 36) the display reads:



With ProdName Lib highlighted, press the PROGRAM KEY (3) to select. The display reads:

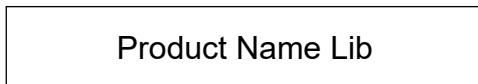

2. Use the up and down PROGRAM ARROW KEYS (4) to scroll through the existing product names. Or press the PRODUCT KEY (14) that corresponds with the first letter of the name you are looking for. Then use the PROGRAM ARROW KEYS (4) to scroll to the desired name.

3. Press the SCAN KEY (9) to edit the name.

4. Use the PRODUCT KEYS (14) to edit the product name. Press the right arrow key to advance to the next character.

To clear the product name, press the TEMP/TOGGLE/CLEAR KEY (11).

*NOTE: Use product key 1 for spaces, periods, quotation marks and underlines.*

5. Once the product name has been entered, press the PROGRAM KEY (3). The display reads:

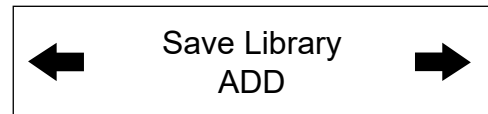

Use the PROGRAM ARROW KEYS (4) to select either ADD, MODIFY or CANCEL. Select ADD to create a new product name. Select MODIFY to change an existing product name. Select CANCEL to exit the edit mode without saving your changes.

*NOTE: To delete an existing product name, find the name in the product library. Press the TEMP/TOGGLE/CLEAR KEY (11) to clear the entire product name. Then select MODIFY to overwrite the name with a clear screen.*

6. Press the PROGRAM KEY (3) to exit the product name library.



# Operation

## Blodgett IQ2™ Vision Control

### Programming the ALARM NAME

*NOTE: Use these instructions to modify an existing name, to add an alarm name or to delete a name already in the library.*

*NOTE: Names may be up to 16 characters long and can contain letters and numbers.*

1. After entering the system level programming (see page 36) the display reads:



Use the PROGRAM ARROW KEYS (4) to highlight Alarm Lib. Press the PROGRAM KEY (3) to select. The display reads:

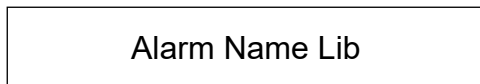

2. Use the up and down PROGRAM ARROW KEYS (4) to scroll through the existing alarm names. Or press the PRODUCT KEY (14) that corresponds with the first letter of the name you are looking for. Then use the PROGRAM ARROW KEYS (4) to scroll to the desired name.
3. Press the SCAN KEY (9) to edit the name.
4. Use the PRODUCT KEYS (14) to edit the alarm name. Press the right arrow key to advance to the next character.

To clear the alarm name, press the TEMP/TOGGLE/CLEAR KEY (11).

*NOTE: Use product key 1 for spaces, periods, quotation marks and underlines.*

5. Once the alarm name has been entered, press the PROGRAM KEY (3). The display reads:

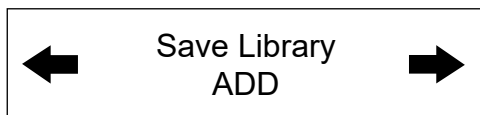

Use the PROGRAM ARROW KEYS (4) to select either ADD, MODIFY or CANCEL. Select ADD to create a new alarm name. Select MODIFY to change an existing alarm name. Select CANCEL to exit the edit mode without saving your changes.

*NOTE: To delete an existing alarm name, find the name in the product library. Press the TEMP/TOGGLE/CLEAR KEY (11) to clear the entire alarm name. Then select MODIFY to overwrite the name with a clear screen.*

6. Press the PROGRAM KEY (3) to exit the alarm name library.

### Exiting the system program mode

1. The display reads:



Use the PROGRAM ARROW KEYS (4) to scroll up until Exit is highlighted. Press the PROGRAM KEY (3). The display reads:

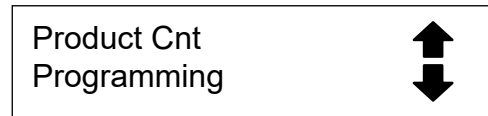

Use the PROGRAM ARROW KEYS (4) to scroll up until Exit is highlighted. Press the PROGRAM KEY (3) to exit the programming mode.



## How Cook & Hold Works

With the optional COOK & HOLD feature, meat is roasted at lower temperatures for longer periods of time. This preserves flavor and tenderness and prevents over drying.

There are three phases in cook and hold roasting.

- Primary Cooking - controlled by the COOK & HOLD TIMER. The meat is cooked at a low temperature until approximately 2/3 done.
- Cooking from Stored Heat - when the primary cook time expires, the oven automatically switches to HOLD. The product continues to cook from the heat stored in the oven. Meat must remain in the hold cycle for a minimum of 1-1/2 to 2 hours before being served.
- Hold - holds the product for several hours before serving without loss of moisture or tenderness.

All meat should be completely thawed by refrigeration. Using frozen meat increases the cook time causing shrinkage.

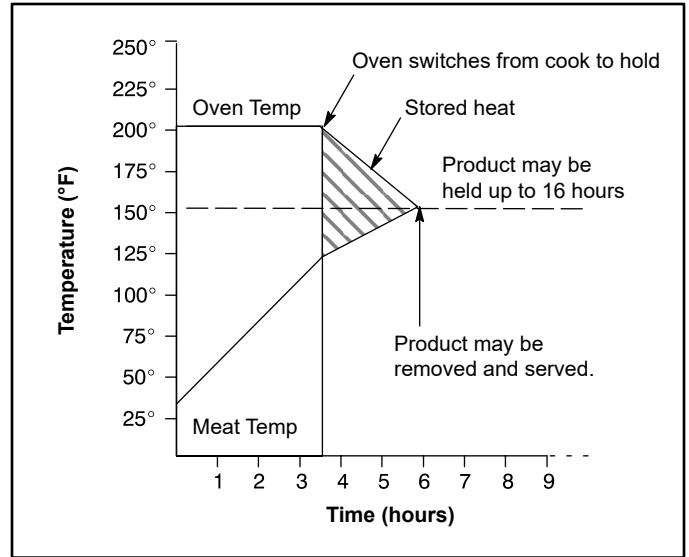

Figure 43

PRODUCT	COOK TEMP.	HOLDTEMP.	QUANTITY	COOK TIME (HRS)	MIN. HOLD TIME (HRS)	TOTAL TIME (HRS)
Prime rib, bone cap off 14-18 lbs. (6.4-8.1 kg)	200°F	140°F	1	3	1	4
	93°C	60°C	3	3-1/4	1-1/2	4-3/4
			6	3-1/2	2	5-1/2
Prime rib, bone cap on 14-18 lbs. (6.4-8.1 kg)	200°F	140°F	1	3-1/2	1	4-1/2
	93°C	60°C	3	4	1-1/2	5-1/2
			6	4-1/2	2	6-1/2
Top or bottom rounds 20-22 lbs. (9.1-10.0 kg)	200°F	140°F	1	3-1/2	1	4-1/2
	93°C	60°C	3	4	1-1/2	5-1/2
			6	4-1/2	2	6-1/2
Pork roast or ham 10-12 lbs. (4.5-5.4 kg)	250°F	170°F	2	4	1	5
	121°C	76°C	4	4-1/4	1-1/2	5-3/4
			6	4-1/2	2	6-1/2
Turkey 20-22 lbs. (9.1-10.0 kg)	250°F	170°F	1	3-1/4	1	4-3/4
	121°C	76°C	6	4	1-1/2	5-1/2
Leg of Lamb, bone in 8-10 lbs. (4.36-4.5 kg)	225°F	160°F	2	2-1/2	1	3-1/2
	107°C	71°C	4	2-3/4	1-1/2	4-1/4
			6	3	2	5



# Operation

---

## General Guidelines for Operating Personnel

### COOK TIMES AND TEMPERATURES

#### Preheating the oven

Always preheat the oven before baking or roasting. We recommend preheating 50°F (28°C) above the cook temperature to offset the drop in temperature when the doors are opened and cold product is loaded into the oven. Set the thermostat to the cook temperature after the product is loaded.

*NOTE: For frozen product, preheat the oven 100°F (56°C) above the cook temperature.*

#### Cook Temperatures

Generally, cook temperatures should be 50°F (28°C) lower than deck or range oven recipes. If the edges of the product are done but the center is raw, or if there is color variation, reduce the thermostat setting another 15-25°F (10-15°C). Continue to reduce the cook temperature on successive loads until the desired results are achieved.

*NOTE: Cooking at excessive temperatures will not reduce cook time, it will produce unsatisfactory baking and roasting results.*

#### Cook Time

Check the product in about half the time recommended for deck or range oven recipes. Record times and temperatures which provide best results for future reference.

*NOTE: Cook time will vary with the amount of product loaded, the type of pan and the temperature.*

### OPERATING TIPS

#### Pans and Racks

Product or pan height determines how many racks are used. The oven holds up to ten 18" x 26" (45.7 x 66.0 cm) bun pans.

Load the oven from the bottom, centering the pans on the rack. Never place a pan or aluminum foil on the bottom of the oven. This obstructs the flow of air and results in uneven baking and roasting.

#### Roasting

To reduce shrinkage when roasting, place meat directly on the racks. Place a sheet pan one-half full of water in the bottom rack position. The water evaporates, increasing humidity in the oven chamber. The pan catches grease from the meat, making oven cleaning easier.

#### Baking

Weigh the product to ensure equal distribution in each pan. Varying amounts of product will cause uneven baking results.

#### Fans

The fan must be operating for the oven to heat. Use the Pulse Plus feature to allow light or liquid product to set in the pan and to avoid rippling towards the fan. If your oven is not equipped with this feature use the following procedure.

1. Preheat the oven 25°F (15°C) above the baking temperature.
2. Load the oven with product. Close the doors.
3. Set the thermostat to the baking temperature.
4. Turn the oven off.
5. Allow the product to set for 5-7 minutes with the fan off. The residual heat in the oven sets the product.
6. Turn the oven on for the remainder of the bake.

#### Lights

Turn the oven lights off when not viewing the product. Leaving the lights on for extended periods of time shortens the bulb life considerably.



## Suggested Times and Temperatures

PRODUCT	TEMPERATURE	TIME	# SHELVES
<b>Meats</b>			
Hamburger Patties (5 per lb)	400°F (205°C)	8-10 mins.	10
Steamship Round (80 lb. quartered)	275°F (135°C)	2 hrs 45 mins.	2
Standing Rib Choice (20 lbs, trimmed, rare)	235°F (115°C)	2 hrs 45 mins.	2
Banquet Shell Steaks (10 oz. meat)	450°F (235°C)	7-8 mins.	5
Swiss Steak after Braising	275°F (135°C)	1 hr.	5
Baked Stuffed Pork Chop	375°F (190°C)	25-30 mins.	5
Boned Veal Roast (15 lbs.)	300°F (150°C)	3 hrs. 10 mins.	2
Lamb Chops (small loin)	400°F (205°C)	7-8 mins.	5
Bacon (on racks in 18" x 26" pans)	400°F (205°C)	5-7 mins.	10
<b>Poultry</b>			
Chicken Breast & Thigh	350°F (175°C)	40 mins.	5
Chicken Back & Wing	350°F (175°C)	35 mins.	5
Chicken (21/2 lbs. quartered)	350°F (175°C)	30 mins.	5
Turkey Rolled (18 lb. rolls)	310°F (155°C)	3 hrs 45 mins.	3
<b>Fish and Seafood</b>			
Halibut Steaks, Cod Fish (frozen 5 oz)	350°F (175°C)	20 mins.	5
Baked Stuffed Lobster (21/2 lb.)	400°F (205°C)	10 mins.	3
Lobster Tails (frozen)	425°F (220°C)	9 mins.	5
<b>Cheese</b>			
Macaroni & Cheese Casserole	350°F (175°C)	30 mins.	5
Melted Cheese Sandwiches	400°F (205°C)	8 mins.	10
<b>Potatoes</b>			
Idaho Potatoes (120 ct.)	400°F (205°C)	50 mins.	5
Oven Roasted Potatoes (sliced or diced)	325°F (165°C)	10 mins.	5
<b>Baked Goods</b>			
Frozen Berry Pies (22 oz)	325°F (150°C)	35 mins.	5 (30 pies)
Fresh Apple Pie (20 oz.)	350°F (175°C)	25-30 mins.	5 (30 pies)
Pumpkin Pies (32 oz.)	300°F (150°C)	30-50 mins.	5 (20 pies)
Fruit Crisp	300°F (150°C)	25 mins.	5
Bread (24 - 1 lb. loaves)	325°F (155°C)	30 mins.	3
Southern Corn Bread	375°F (190°C)	15-20 mins.	5
Baking Soda Biscuits	400°F (205°C)	6 mins.	5
Brown & Serve Rolls	350°F (175°C)	15 mins.	5
Sheet Cakes (5 lb. mixed batter per pan)	325°F (160°C)	16-18 mins.	5
Chocolate Cake	325°F (160°C)	20 mins.	5
Brownies	325°F (150°C)	15 mins.	5

*NOTE: Actual times and temperatures may vary considerably from those shown above. They are affected by weight of load, temperature of the product, recipe, type of pan and calibration of thermostat. Should your recipe vary, write in your proven time and temperature for ready reference.*



# Maintenance

---

## Cleaning and Preventative Maintenance

### CLEANING THE OVEN

Painted and stainless steel ovens may be kept clean and in good condition with a light oil.

1. Saturate a cloth, and wipe the oven when it is cold.
2. Dry the oven with a clean cloth.

On the stainless front or interiors, deposits of baked on splatter may be removed with any non-toxic industrial stainless steel cleaner. Heat tint and heavy discoloration may be removed with any non-toxic commercial oven cleaner.

1. Apply cleaners when the oven is cold. Always rub with the grain of the metal.

The porcelain interior can be cleaned with any commercial oven cleaner. Be sure caustic cleaning compounds DO NOT come in contact with the temperature probe, aluminized steel heating element cover, and blower wheel.

1. Remove the racks, rack supports and blower wheel from the oven.
2. Soak the parts in a solution of ammonia and water.
3. Reinstall after cleaning.

### Weekly Cleaning

In addition to the daily cleaning it is necessary to clean the air intakes on a weekly basis. Air intakes provide necessary cooling air to the internal components. They are generally located on the rear and sides of the equipment

### PREVENTATIVE MAINTENANCE

The best preventative maintenance measures are, the proper installation of the equipment and a program for routinely cleaning the ovens.

#### Annual Maintenance

This oven requires no lubrication, however, the venting system should be checked annually for possible deterioration resulting from moisture and corrosive flue products.

If maintenance or repairs are required, contact your local Blodgett service company, a factory representative or the Blodgett Oven company.



#### **WARNING!!**

**Always disconnect the appliance from the power supply before servicing or cleaning.**



POSSIBLE CAUSE(S)	SUGGESTED REMEDY
<b>SYMPTOM: Heating elements do not come on.</b>	
<ul style="list-style-type: none"> <li>• Oven not plugged in.</li> <li>• Power switch on the control panel is off.</li> <li>• Control set below ambient temperature.</li> <li>• Doors are open.</li> <li>• Computerized controls - error code on display.</li> </ul>	<ul style="list-style-type: none"> <li>• Plug in electrical supply cord.</li> <li>• Set the control panel to COOK or OVEN ON.</li> <li>• Set to desired cook temperature.</li> <li>• Close doors.</li> <li>• *</li> </ul>
<b>SYMPTOM: Oven does not come to ready.</b>	
<ul style="list-style-type: none"> <li>• The oven has not reached preheat temperature.</li> <li>• Fan delay feature may be activated, if applicable.</li> <li>• Internal problem with main temperature control.</li> </ul>	<ul style="list-style-type: none"> <li>• Wait for oven to reach preheat temperature.</li> <li>• Deactivate fan delay feature.</li> <li>• *</li> </ul>
<b>SYMPTOM: Convection fan does not run.</b>	
<ul style="list-style-type: none"> <li>• Oven is not plugged in.</li> <li>• Oven is not set to the cook mode.</li> <li>• Circuit breaker tripped.</li> <li>• Fan delay feature may be activated, if applicable.</li> <li>• Doors are open</li> </ul>	<ul style="list-style-type: none"> <li>• Plug in electrical supply cord.</li> <li>• Set the control panel to COOK or OVEN ON.</li> <li>• Reset the breaker.</li> <li>• Deactivate fan delay feature.</li> <li>• Close doors.</li> </ul>
<b>SYMPTOM: General baking problems.</b>	
<ul style="list-style-type: none"> <li>• Computerized controls - incorrect product programming.</li> <li>• Thermostat out of calibration.</li> </ul>	<ul style="list-style-type: none"> <li>• Reprogram control per Operation section.</li> <li>• *</li> </ul>
<p><i>*Denotes remedy is a difficult operation and should be performed by qualified personnel only. It is recommended, however, that All repairs and/or adjustments be done by your local Blodgett service agency and not by the owner/operator. Blodgett cannot assume responsibility for damage as a result of servicing done by unqualified personnel.</i></p>	

 **WARNING!!**

**Always disconnect the power supply before cleaning or servicing the oven.**