

# Champion®

The Dishwashing Machine Specialists

Project \_\_\_\_\_

Item No. \_\_\_\_\_

Quantity \_\_\_\_\_

PRO SERIES RACK CONVEYOR

## STANDARD FEATURES

- Perpetual rack advance system, with intuitive jam alert, and drive protection
- Proportional rinse, delivering unmatched total ware coverage, utilizing digital pattern cloning stainless steel nozzles
- Programmable de-lime notifications and de-lime automated cycles
- 255 Racks per hour
- 100 GPH with energy sentinel (idle pump shut-off)
- Prodigy series HMI display, intuitive condition alerts, with user friendly cleaning and operation visual guidance, multi-lingual, touch control
- Proactive maintenance interface, self-diagnostics, problem recognition, with repair recommendation, from HMI touch screen
- Automatic tank fill
- Programmable machine dwell with automatic rack alignment into the optimal wash zone
- Automatic drain valve
- Single-piece hood design
- Single-piece stainless steel upper and lower wash arm manifolds
- Single-point electrical connection
- 20" Standard vertical clearance which accommodates 18" x 26" sheet pans
- Full 180° opening leak proof insulated hinged access doors
- Stainless steel heavy gauge construction including base, legs and feet
- Enclosure panels (front and sides)
- 2 HP pump motor, with stainless steel impeller
- Factory authorized start-up
- Vent fan control
- **ENERGY STAR® Certified**
- **Made in America**

## 76 PRO STEAM

54" Single Tank + 22" Prewash  
High Temperature Rack Conveyor  
Dishwashing Machine



*Photo is for general visual representation only. Please refer to specifications for the latest detailed product information.*

## SPECIFIER STATEMENT

Specified unit will be Champion model 76 PRO Steam series high temperature rack conveyor dishwashing machine. Features top mounted prodigy HMI user interface controls with proactive maintenance software, proportional rinse, using only 100 GPH, built-in booster, progressive anti-jam drive system, energy sentinel (idle pump shut-off), 255 racks per hour, single-piece hood design, single-piece stainless steel upper & lower wash arms manifolds, full 180° opening leak proof insulated hinged access doors.

1 Year parts and labor warranty.



Champion Industries, Inc.  
3765 Champion Blvd., Winston-Salem, NC 27105  
Tel: 336-661-1556 Fax: 336-661-1979  
[championindustries.com](http://championindustries.com)

Champion Industries, Inc.  
2764 North Service Rd., Jordan Station, Ontario Canada L0R 1S0  
Tel: 905-562-4195 Fax: 905-562-4618  
[championindustries.com/1canada](http://championindustries.com/1canada)

CH070

# 76 PRO STEAM

54" Single Tank + 22" Prewash  
High Temperature Rack Conveyor  
Dishwashing Machine

# Champion®

The Dishwashing Machine Specialists

## OPTIONS

- 33" Blower dryer – steam
- Direct link connectivity solution
- Direct link plus+ connectivity solution

## ACCESSORIES

- Drain water tempering kit (unmounted)
- Table limit switch, unmounted (recommended on all rack conveyor installations) (unmounted)
  - Whisker style
  - Button style
- Vent cowl, stainless steel with 7" stacks & locking dampers
- Extended vent cowl, with 7" stacks, locking dampers & external curtain
- Flanged feet (unmounted)
- Water hammer kit (unmounted)
- Chemical pump kit (detergent and rinse aid, mounted and interwired)
- Water pressure regulating valve (unmounted) (standard with booster)
- ION scale prevention device (unmounted)
- Water softening system (manufactured, warranted and serviced by Kinetico)
- Dish racks:
  - Peg rack
  - Flat rack
  - Sheet pan rack
- Splash shields
- Cantilever sideloader (without hood) for 90° load operation
  - 24" Sideload
  - 30" Sideload (accepts sheet pans)
- Model PRO-90B loader or unloader (90° corner conveyor table)
- Model RCT 64 or RCT 84 roller conveyor table (see factory for custom length)
- Stainless steel rear enclosure panels
- Correctional package (contact factory)



**NEW PRO-90B**  
90° Corner Conveyor  
table (shown)  
Loader or Unloader



**Cantilever Sideloader**  
(no hood)



**Model RCT 64 or  
RCT 84**

Roller conveyor  
table

# 76 PRO STEAM

54" Single Tank + 22" Prewash  
High Temperature Rack Conveyor  
Dishwashing Machine



Utilities	
<b>1</b>	<b>Electrical Connection</b> Machine electrical connection
<b>2</b>	<b>Hot Water</b> Machine with built-in booster Main connection 1/2" NPT
<b>4</b>	<b>Hot Water</b> Machine with no booster Main water connection 1/2" NPT
<b>5A</b>	<b>Drain</b> Connection 1-1/4" NPT Drain Max Flow Rate (g/min) 15
<b>6A</b>	<b>Steam</b> 1-1/4" NPT machine & booster (10-30 PSI) flow pressure
<b>7A</b>	<b>Condensate</b> 3/4" NPT machine return to boiler. <b>No back pressure.</b>
<b>8</b>	<b>Vents</b> <b>A</b> Stack connection - load end 150 CFM @ 1/4" static pressure <b>B</b> Stack connection - unload end 400 CFM @ 1/4" static pressure

**Warning:** Plumbing and electrical connections should be made by qualified personnel who will observe all the applicable plumbing, sanitary, safety codes and the National Electrical Code.

**Note:** Water Hammer Arrestor (meeting ASSE-1010 standard or equivalent) to be supplied (by others) in common water supply line at service connection.

**Optional Drain Tempering:** 1/2" NPT cold water connection required. 1/2" NPT drain connection from back flow preventer to house drain. (FIELD INSTALLED and PLUMBED).

**Plumbing Notes:** Because of the variation in house-supplied steam and water pressures, steam and water pressure regulating valves (PRVs) may be needed (water PRV is standard on machines with booster). The PRVs can either be purchased from Champion or obtained locally.

Recommended water hardness of 3 grains/US Gal (0.83 Imp Gal) - 5.3 Mg/L or less

**Venting Notes:** Fabricated duct sizes: 3-7/8" x 15-7/8" (outside dimensions).

## SPECIFICATIONS

### Capacity

Racks per hr. (NSF rated).....	255
Wash tank (US gal.).....	17
Prewash tank (US gal.).....	9
Conveyor speed (ft./min.).....	7.1
Conveyor speed Pot/Pan Mode (ft./min.).....	5.4
(only one rack at a time in Pot/Pan Mode)	

### Motor Horsepower

Drive.....	1/6
Wash.....	2
Prewash.....	2

### Water Consumption

US Gal. per hr. (max use).....	100
US Gal. per rack.....	.39

### Heating 10-30 PSI flow pressure

Tank heat, steam (lbs./hr. required).....	75
Steam booster (lbs./hr. required for 70° F rise).....	110

*Booster heaters completely inter plumbed, controls are interwired.*

### Venting

Load end (minimum CFM).....	150
Unload end (minimum CFM).....	400

### Standard 20" X 20" rack complement

Peg.....	1
Flat.....	1

76 PRO Steam Tank Heat with 70°F Rise Booster			
Electrical Specifications	Rated Amps	Minimum Supply Circuit Ampacity	Maximum Overcurrent Protective Device
208/60/3	16	20	20
240/60/3	15	20	20
480/60/3	7	15	15
575/60/3	6	15	15

# 76 PRO STEAM

54" Single Tank + 22" Prewash  
High Temperature Rack Conveyor  
Dishwashing Machine

# Champion®

The Dishwashing Machine Specialists

## MODEL 76 PRO STEAM

Shipping weight crated: **1000 lbs.**

Dimensions shown in inches [mm]

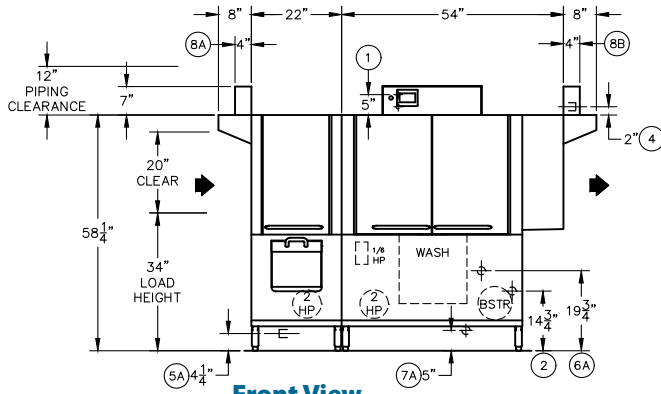

**Front View  
Left to Right**

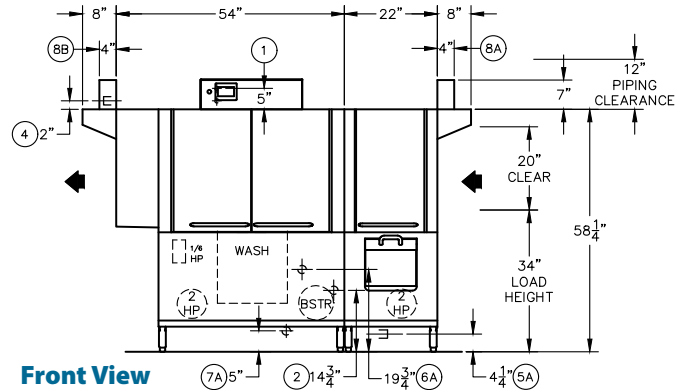

**Front View  
Right to Left**

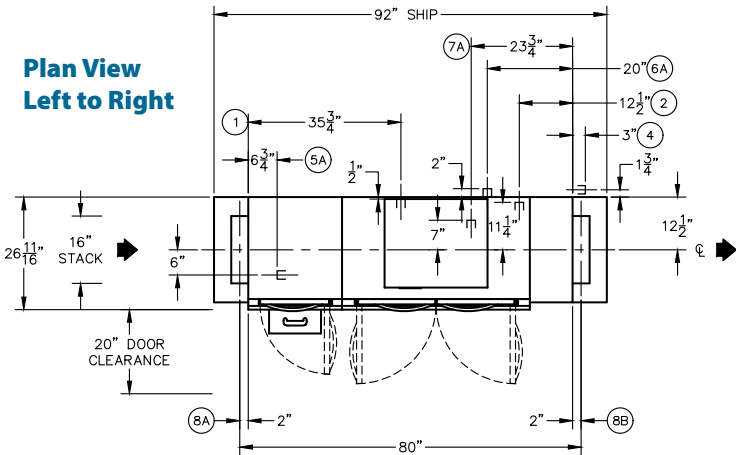

**Plan View  
Left to Right**

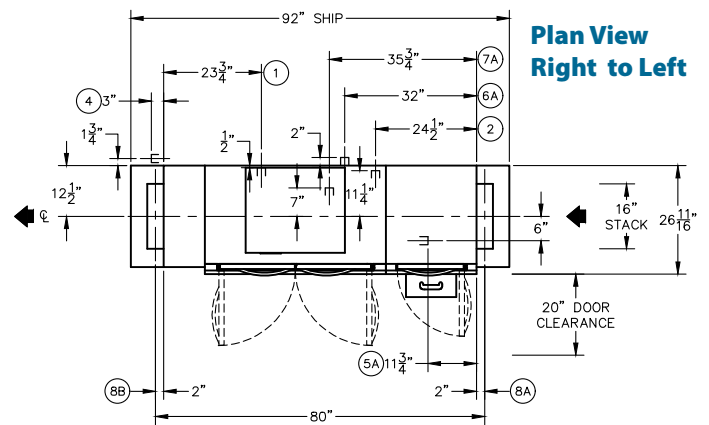

**Plan View  
Right to Left**

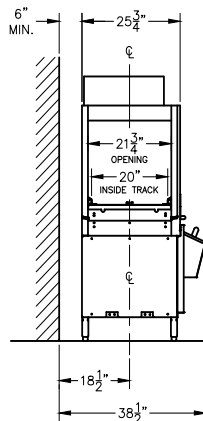

**End View**

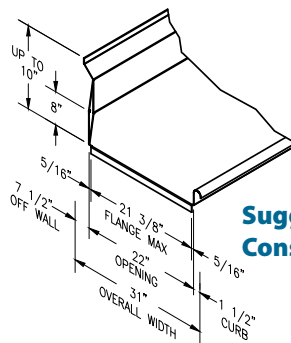

**Suggested Table  
Construction**

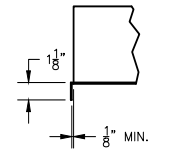

**Flange Details**