



Dishwasher Undercounter

500

AMPTO | 8409 NW 68th Street Miami, FL 33166

Ph: (786) 536-9960 | Fax: (305) 960-7796

info@ampto.com

www.ampto.com

General Information - Installation Checklist

Upon of the delivery please inspect for external visible damages. If package has suffered rough handling or damages please open the carton to inspect the item in the box as well. Please note to everything on the BoL before accepting the delivery.

The Dishwasher must be installed by a certified plumber.
Failing to follow the instructions/checklist below will void the warranty.

Checklist

<input type="checkbox"/>	Check water hardness. If water hardness exceeds 7 grains per gallon, a water softener must be installed.
<input type="checkbox"/>	Ensure the correct placement and leveling of the machine as per the manual.
<input type="checkbox"/>	The water supply hose / pipe should be flushed before the final connection.
<input type="checkbox"/>	The dishwasher must be connected to a hot water source with a minimum temperature of 40°Celsius /104° Fahrenheit.
<input type="checkbox"/>	Adjust water pressure using the PRV to 20 PSI, while filling the machine with water.
<input type="checkbox"/>	Rinse and detergent containers can be adjusted at the bottom of the machine by rotating the adjustment screws on the pumps. Adjust rinse/detergent flow to manufacturers recommendations. 2.6 ml per rotation for DETERGENT – 1.2 ml per rotation for RINSE. <i>*Rinse/Detergent containers must be equal or lower in height than the pumps*</i>
<input type="checkbox"/>	Do not add an extension to the drain hose, drain connections must be made in the same flow with the drain pipe. Do not install drain hose to exceed 26 inches / 65 cm above the ground.
<input type="checkbox"/>	If the tank temperature gauge is not inside the green zone, the installer must adjust to 80° Celsius / 176° Fahrenheit.
<input type="checkbox"/>	If the booster gauge is not inside the green zone, the installer must adjust to 80° Celsius / 176° Fahrenheit.
<input type="checkbox"/>	If no water filtration/softener system is used, descale every 4 weeks

Technical Specifications

model	AMPTO 500
Voltage	208-240 Volt
Max Power	3800 Watt
Max Amperes	16 Amps
Boiler heating element	3100 Watt
Tank heating element	2900 Watt
boiler capacity	6 Lt
tank capacity	35 Lt
Ex Dimensions	570 X 600 X 830 mm (22,4 X 23,6 X 32,6 inch)
basket dimensions	500 X 500 mm(19 X 19 inch)
Washing cycles	120 sec / 240 sec / 360 sec
Washing pump power	0.75 HP
peristaltic detergent pump ml / rotation	2.5 ml
peristaltic rinse aid pump ml / rotation	1.5 ml
draining pump	Standard
max glass	325 mm (12,8 inch)
max dish	335 mm (13,1 inch)
self diagnostics	standard

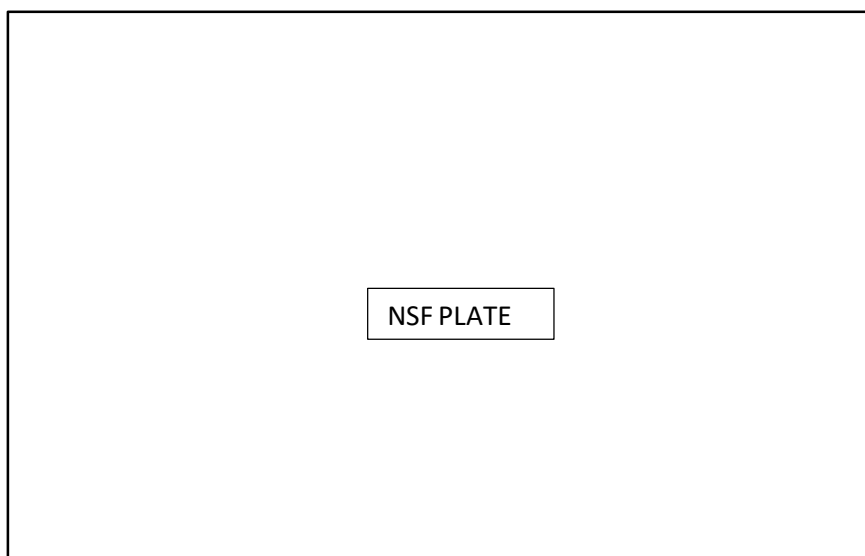

Safety and Warranty

The following symbols indicate important information throughout this manual

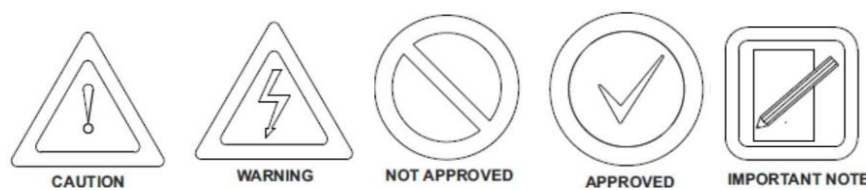

1. All plumbing connections must be made prior to the electrical connection as otherwise there is high risk of damages to heating elements.
Damages due to negligence installation are not covered by the warranty.
2. Be careful when lifting or moving the dishwasher to avoid leaks or damages.
3. Do not use granular detergent. Poor results usually occur.
4. Do not use caustic products. This will void the guarantee.
5. Be sure all electrical supply specifications correspond to information label on machine

Installation

Placement of Dishwasher

1. Inspect the packaging for external damages
2. Check that all the following accessories are inside the machine
 - 1X Glass basket
 - 1X Dish basket
 - 1X Cutlery basket
 - 1X Water inlet hose
 - 1X Pressure reducer valve (PRV)
 - 4X leveling feet
 - 4X thread covers for leveling feet
 - 1X User manual
3. Install the leveling feet by following the instructions
4. Level the machine front to back and right to left
5. Pull aside the chemical feeders' tubes
6. Place the machine in the correct location

AMPTO 500 USER'S MANUAL

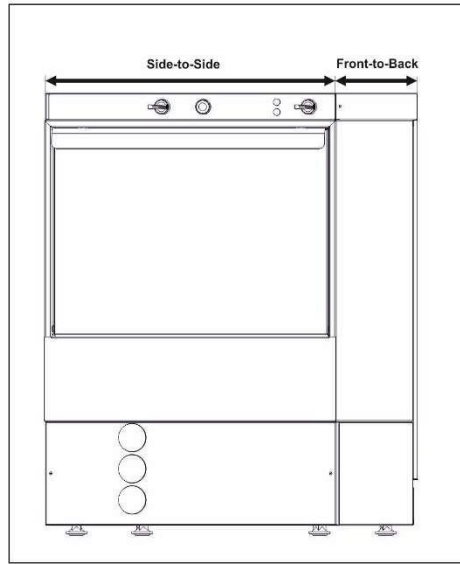

Adjust the legs to level the machine side-to-side and front-to-back

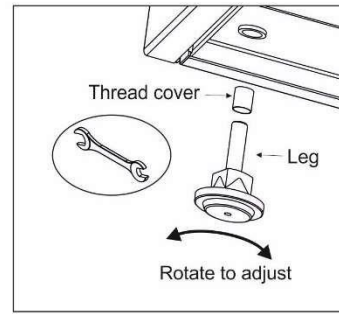

Exploded view leg detail

Placement of Chemicals



1. Chemical supply containers must be placed as close as possible to the machine and must not be elevated.
2. Reposition the chemical tubing at the back of the machine before placing the machine to its permanent position.

The unit should be installed by licensed and approved personnel according to all local codes.

This dishwasher is delivered with water inlet and outlet hoses.

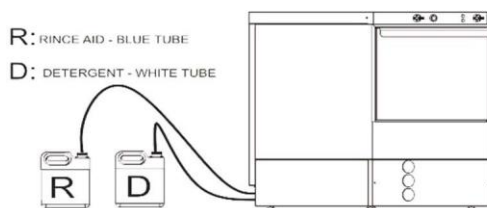

Chemical supply containers must be placed as close as possible to the machine and must not be elevated.



Reposition the chemical tubing at the back of the machine before placing the machine to its permanent position.

AMPTO 500 USER'S MANUAL

Water Supply Connection

- This dishwasher intended for use with a hot water supply but will also operate (at slightly reduced hourly capacity) with a cold water supply. Minimum income water temperature should be 40°C.
- The water supply hose/pipe should be OD 14mm x ID 10mm and terminate in a 3/4" NPT fitting (not garden hose).
- The water supply hose/pipe should be flushed before final connection.
- Install the PRV valve as maximum flow pressure is 15 PSI and maximum is 25 PSI.
- Connect hose supplied with machine to the inlet at the rear of the machine and the 3/4" NPT fitting on the water supply line.

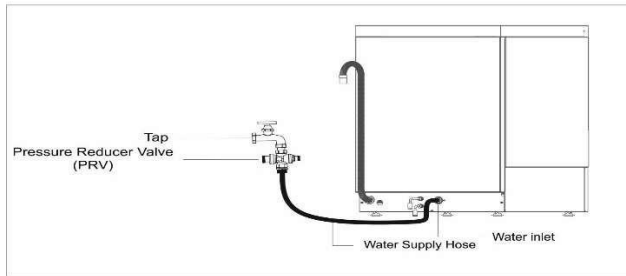

Machine must be connected to hot water source. Minimum income water temperature should be 40°.



A Pressure Regulator Valve must be inserted between the machine water inlet and the water source. Water pressure must be regulated to 20 PSI. During pressure regulation please check the pressure gauge at the front of the machine.

PRESSURE REGULATOR VALVE ADJUSTMENT

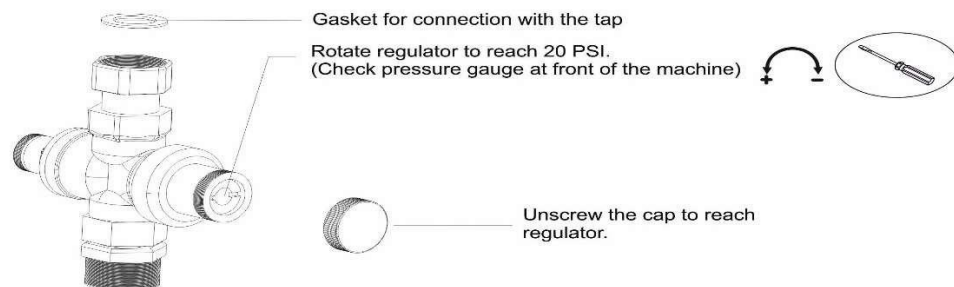

Make sure that no residuals remain to the water supply line before connecting it to the machine. Plumbing connections must be made in such way that will allow the machine to be moved for service and cleaning.

PRV MUST be installed and adjust at 20 PSI otherwise the warranty is voided.

Min incoming temp	Operating flow pressure	Min wash temperature	Min rinse temperature
40°C	20 ±5 PSI	165 °F / 74 °C	165 °F / 74 °C

AMPTO 500 USER'S MANUAL

Connect the PRV valve in the water supply shut off valve.

Connect the water supply hose to the PRV in one side and in the machine on the other side.

Attention: source water hardness must not intervene 10°F / 6 Gd.

Drainage Connection

Outflow is accomplished by the use of a drain pump in the CD-GR-0500. The outlet hose must not be higher than 650mm from the floor. An open drain connection or one to a vented drain pipe is recommended.

- Connect the drain hose to the main draining.
- Connection must be made in the same flow with the draining pipe.



CAUTION

- Drain connection to a venting dedicated drain pipe is suggested.
- It is strongly advised NOT to connect the drain hose into the sink's draining.
- If an extension is added to the drain hose the warranty is voided.

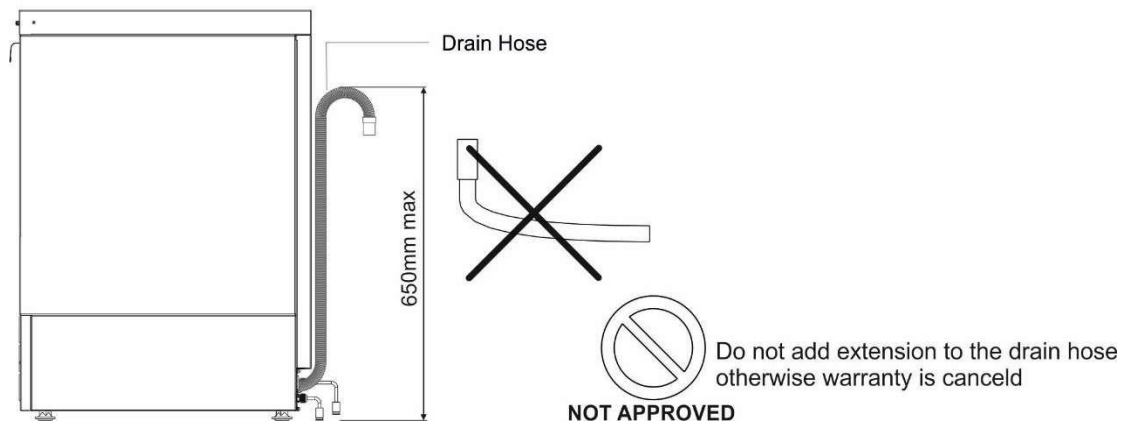

Electrical Connection



WARNING

Attention: Before make any electrical connection or service, disconnect the main electrical supply and lock it out in order to clearly indicate that there is work in progress.

- Open the lower front cover (2 bolts)
- Open the top cover of electrical circuit
- Connect the cable to the terminal block (Attention : strain relief knockout must be placed by the installer)
- Caution: 15 cm loop of wire must be left inside the machine in order to allow servicing.
- Replace the top cover

AMPTO 500 USER'S MANUAL

- Replace and secure the lower front cover

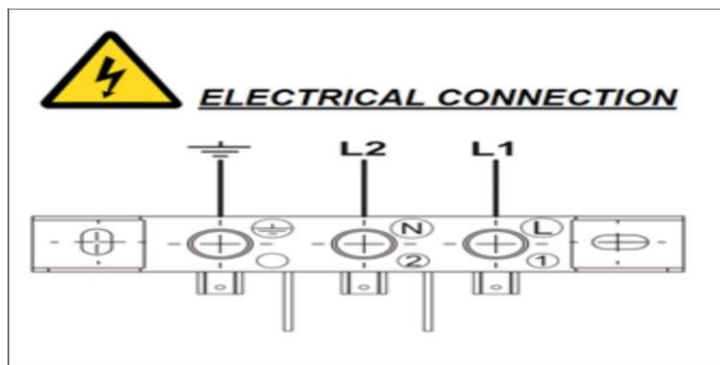

Detergent and Rinse aid pump adjustment

Control Panel Draw

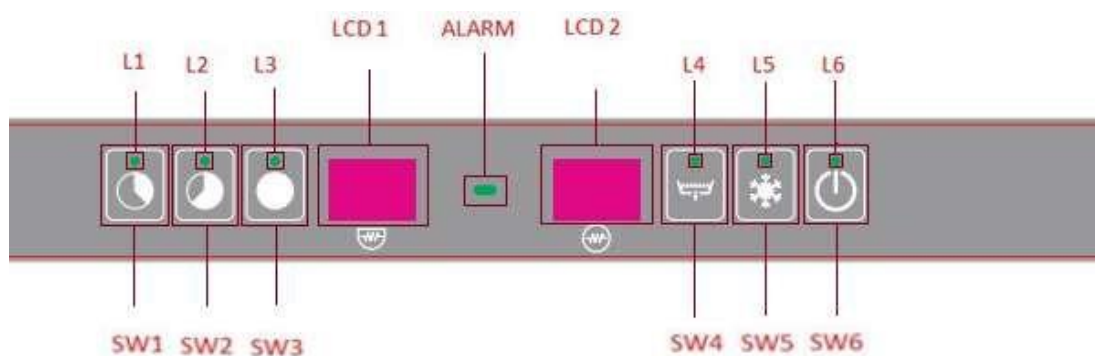

This machine is equipped with peristaltic detergent and rinse aid pumps that are controlled through the PCB board. For that reason in order to adjust the dosing of each one you have to enter the **User's Menu** by following the below steps, please bear in mind that for each second the corresponding pump captures the following liquid quantities:

Detergent pump: 0.83 ml/sec

Rinse Aid pump: 0.19 ml/sec

By multiplying these quantities with the time duration (seconds) that the pump works, you can calculate the volume of each liquid that it is used.

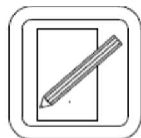

IMPORTANT NOTE

To navigate in the user menu by pressing the buttons SW3 and SW4

To increase the amount (+), press Button SW1

To decrease the amount (-), press Button SW2

To confirm the value changed, press Button SW5 once.

- Press hold Buttons SW1, SW3 & SW6 at the same time for 3 sec with the hood-door closed. LED L6 flashes and buzzer sounds three times. Message "conf" appears for a few seconds and the User's Menu is activated.

AMPTO 500 USER'S MANUAL

- select dF to adjust detergent quantity during initial filling
- Select dC to adjust detergent quantity during each washing cycle
- Select rF to adjust rinse aid quantity during initial filling
- Select rC to adjust rinse aid quantity during each washing cycle
- Exit the **User's Menu** hold SW 6 for 3 sec. until to hear the buzzer sounds.

Prime the chemical pumps

Each pump is priming separately. To do that follow the steps bellow.

Detergent pump priming :

Dishwasher on standby (OFF)

Door closed

Hold the buttons SW1, 3, 5 together

Rinse aid pump priming :

Dishwasher on standby (OFF)

Door closed

Hold the buttons SW1, 3, 4 together



Before you perform these adjustments, turn off the power supply.

The dozer is adjusted from the manufacturer's premises at its maximum value for easy initial priming and must be adjusted accordingly (depending on water hardness, how dirty the dishes are, and the detergent used).

AMPTO 500 USER'S MANUAL

Screeners (surface filters) and Overflow pipe

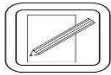
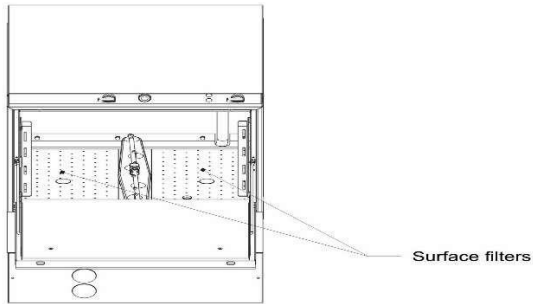

To remove the surface filters first align the rinse and washing arms with the middle filter support and then lift.

IMPORTANT NOTE



Do not remove the surface screeners and internal filters if the tank is not empty

CAUTION

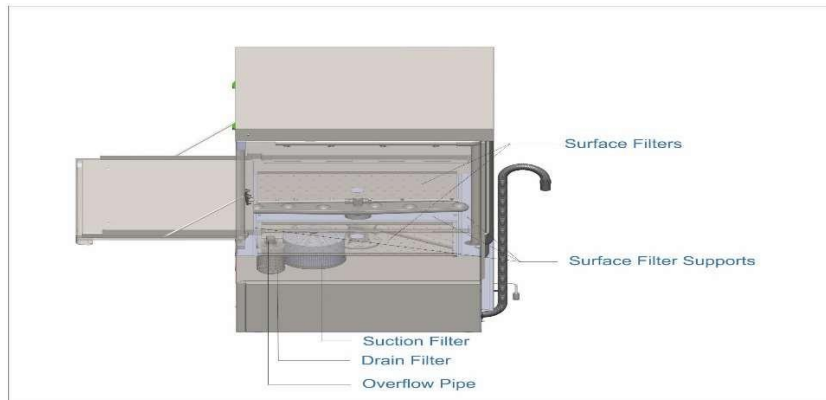



Operation

Daily operation

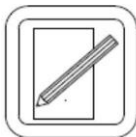
- Check the chemical containers to be sufficient full.
- Reposition the overflow pipe and the surface screeners .
- Turn on the dishwasher by pressing button SW6 for 3 sec. The LED L6 will flash and the buzzer will sound.
- Wait the tank to fill up with water and chemical pumps to prime. During priming the indication "FILL" will keep appear on the two 7 segment screens.



IMPORTANT NOTE *The heating elements start warming only when filling is finished. On the screens LCD1 & LCD2 the current temperature of each tank is displayed alternately (when LCD 1 shows "bt" then LCD 2 displays boiler's temperature, when LCD 1 shows "tt", then LCD 2 displays tank temperature). In case that the wash tank's heating resistance is ON, a dot in the right lower corner of LCD1 is lit, while in case that the boiler's heating resistance is ON a dot in the right lower corner of LCD2 is lit. For that reason, symbol  (representing the tank) is shown beneath of LCD1 & symbol  (representing the boiler) is shown beneath of LCD2.*

- Wait 20 minutes in order both the tank and booster to be fully heated

AMPTO 500 USER'S MANUAL



IMPORTANT NOTE During the first full warming at the start of the swift the washing cycle does not start until the dishwasher to be fully warmed



The full heating process is finished when both booster and tank temperatures are minimum 74oC

- Load the basket in a proper way and place it inside the machine.

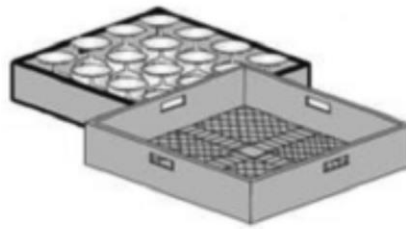
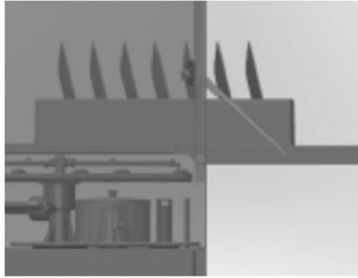

All the residuals on the dishes and glasses must be removed

- Close the door
- Start a washing cycle by pressing the preferable washing cycle time button

Program	Wash time	Rinse time
Short (SW 1)	103 sec	16 sec
Standard (SW 2)	163 sec	16 sec
Long (SW 3)	223 sec	16 sec



IMPORTANT NOTE If for any reason the door open the washing cycle is stopped and must start all over again.

Detergent and rinse aid pump operation

This machine is equipped with peristaltic pumps for the rinse aid and the detergent filling. The filling inlets for each one are the two corresponding hoses which should be immersed in the appropriate tanks.

AMPTO 500 USER'S MANUAL

The dosing procedure is performed in two stages. Firstly during the initial filling (when you turn the machine on) and additional after each washing cycle:

1st Stage: During automatic preparation (before the first wash) the machine receives from the tank soap for 180 sec and rinse aid for 35 sec. This could be adjusted from the user through the User Menu *Check Section "User Menu".

2nd Stage: During every complete washing & rinsing cycle, the machine receives detergent for 13 sec and rinse aid for 12 sec. This could be adjusted from the user through the User Menu *Check Section "User Menu"

Control Panel Draw

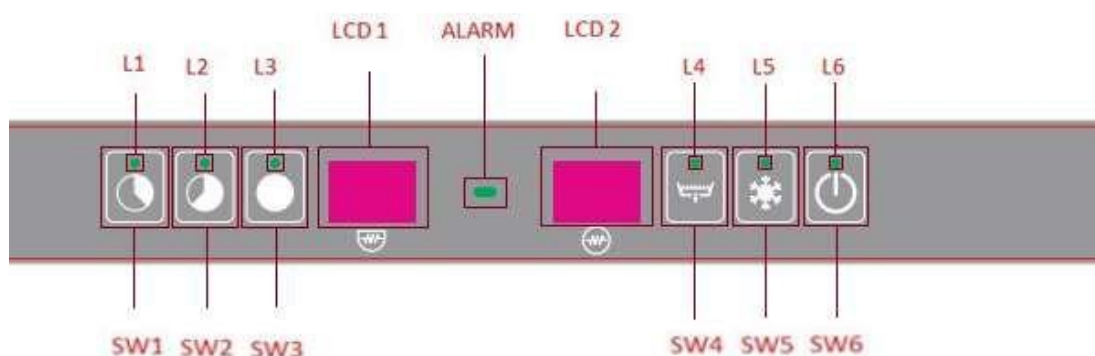

- When "END" appears on the 2 7 segment screens the washing cycle has finished and you can remove the basket.
- Allow the dishes and glasses to dry out of the dishwasher



The dishwasher is equipped with thermo-protector so the rinsing does not start unless the rinse temperature to be 165 °F / 74 °C. In this case washing cycle time may be extended until the final rinse temperature to reach 165 °F / 74 °C.

Pay attention on removing the basket after the washing cycle as it may be HOT.

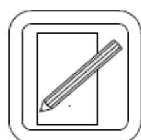

- For best results avoid allowing food residues to dry.
- Remove bulk food residues, olive pips, lemon peels, toothpicks, etc., before placing the dishes in the basket.
- If washing is delayed we recommend that you soak dishes and/or glasses which have food residues.

If, after washing, there are stains from dirt or water spots, the cause may be one of the following:

AMPTO 500 USER'S MANUAL

- Wrong ratio of detergent to water.
- Rinsing water with very high mineral content.
- Improper quantity of rinse-aid.
- Wrong arrangement of items in the basket.
- Low water pressure during rinsing.
- Low water temperature during washing.
- Clogged or miss-positioned filters.
- Clogged jets.

Shutting Down and Draining

- Remove the overflow pipe.
- Press the draining button SW 4 in order to start draining process

Attention: Do not remove the surface screeners and internal filters if the tank is not empty.

- When draining cycle is finished the dishwasher turns off automatically.

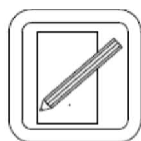

IMPORTANT NOTE

- The draining process includes also self cleaning so during draining hot water from the booster will be sprayed inside the tank in order residuals to be removed.
- Draining time can be adjusted (more or less) by entering the general settings of the machine
- Remove the surface filters and clean them under running water.
- Remove the suction filter and the draining filter and clean them under running water.
- Reposition the filters and overflow pipe.



CAUTION

DO NOT use any metal sponge to scratch the filters or the dishwasher surface.

Maintenance

Proper operation and safe use may be ensured only through the correct use of the appliance, as well as the compliance with the operation instructions, the corresponding specifications and the care and cleaning indications.

Depending on local water hardness, the nozzles on the upper wash piping and rinse arms should be cleaned. Caution must be exercised to not damage the nozzles. If rinse nozzles are removed, they must be replaced with the slot in line with the rinse arm.



CAUTION

ATTENTION MUST BE GIVEN TO THE CORRECT INSTALLATION OF FILTERS, WASH ARMS, AND TEFLON BUSHINGS! REPLACE BUSHINGS IF WORN.

AMPTO 500 USER'S MANUAL

Clean the appliance with warm water and conventional cleaning aids. Stainless steel parts should never be cleaned them with “steel wool” wire brush, etc, since even the lightest contacts on the surfaces with steel may contaminate the stainless steel and cause rust formation. Use brushes made of polymer plastic or natural bristles or thin brass wire. Always keep brush movements in line with grain in the Stainless Steel so that you will not affect the appearance. Finally, rinse with clean water and dry thoroughly.

We remind you that corrosion (rust formation) on stainless steel surfaces is not created by itself, but rather due to the use of improper cleaning products (e.g. whitening or particularly caustic cleaning products based on chlorine).

Occasionally calcium sediments form on the internal walls of the wash compartment, tubing, and booster chamber (due to mineral particles in the water), which may affect the correct operation of the appliance and which requires removal.

User's Menu



IMPORTANT NOTE

- 1. User's menu has two levels of parameterization. In order to enter the second level please advice distributor's after sales department.**
- 2. For setting the default parameters at any time please advice distributor's after sales department.**

In order to enter the User's Menu, shut down the machine and press hold Buttons SW1, SW3 & SW6 at the same time for 3 sec with the hood closed. LED L6 flashes and a beeper sounds three times. Message “conf” appears for a few seconds and the User's Menu is activated.

Find the parameter that you wish to adjust using Buttons SW3 and SW4 for navigation inside the menu. The corresponding parameter will be displayed on the screen.

Should you wish to increase the amount (+), press Button SW1

Should you wish to decrease the amount (-), press Button SW2

After defining the value, press Button SW5 once in order to register the value in the memory.

In the matrix that is presented below you can find a short description of the functions that can be adjusted by the user, as well as their default values.

In order to exit the User's Menu, press-hold Button SW6 for 3 sec. The beeper sounds three times and message “OFF” appears on screens

After closing the User's Menu, the machine is shut down.

No	Parameter	Range	Default	Indication
1	TEMPERATURE MODE	C/F	C	C
2	BOILER TEMPERATURE	30-92 C	85 C	bt
3	TANK TEMPERATURE	30-70 C	60 C	tt
4	DETERGENT TIME AT FILLING	100 – 300 SEC	180 SEC	dF
5	DETERGENT TIME AT CYCLE	0 – 30 SEC	13 SEC	dc
6	RINSE AID TIME AT FILLING	0 – 90 SEC	35 SEC	rF
7	RINSE AID TIME AT CYCLE	0 – 30 SEC	12 SEC	rC
8	ADDITIONAL RINSE	0 (NO) – 1 (YES)	0	Cr
9	DRAINING DURATION	20 -60 SEC	25	Cd

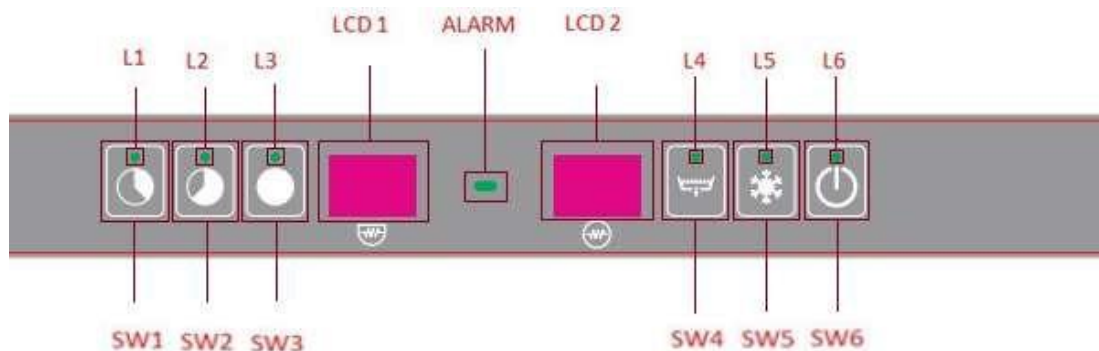

Troubleshooting

Alarms

If the system records any malfunction, then a warning message will be displayed on the screen. If such a condition occurs, please advise the following table which describes the problem shortly. Should you need further assistance, don't hesitate to contact your local reseller.

ALARM	PROBLEM DESCRIPTION
Alarm 1	Filling time excession
Alarm 2	The water level during draining is not reduced
Alarm 3	Excess time of boiler heating
Alarm 4	Excess time of tank heating
Alarm 5	Water temperature in the boiler is above limits
Alarm 6	Water temperature in the wash tank is above limits
Alarm 8	Tank's thermometer is not connected
Alarm 9	Tank's thermometer is damaged
Alarm 10	Boiler's thermometer is not connected
Alarm 11	Boiler's thermometer is damaged
Alarm 12	The washing cycle is terminated, but the boiler was not heated properly (excess heating time in Thermo-protector function)

Troubleshooting

PROBLEM	CAUSE	REMEDY
The dishwasher does not operate properly	Connection interruption	Check the connection
	You have not turned the switch of the appliance ON	Turn the switch ON
	Main switch / or fuse has not been activated / or it is faulty	Check the main switch / or fuse
	The switch of the appliance is faulty	Refer to the authorized local dealer who sold the appliance or directly to the manufacturer
	The water inlet valve is faulty	
	The door is not closed	Close the door

AMPTO 500 USER'S MANUAL

	You have not turned the water supply on	Turn the supply on
The appliance operates, but the switch LED does not light on	The LED is faulty	Change the LED
Boiler heating does not operate	Switch or main switch or fuse has not been activated	Check the switch of the appliance and the main switch or fuse
	The safety thermostat of the boiler is faulty	Refer to the authorized local dealer or the manufacturer
	The 93°C thermal fuse of the boiler is faulty	
	Pressure regulator is faulty "Boiler heating" relay is faulty	Refer to the authorized local dealer or the manufacturer
	Boiler fuse is burned out	Refer to the authorized local dealer or the manufacturer
Boiler heating operates, but LED does not turn on	Faulty LED	Change LED
Dispenser heating does not operate	Switch N1 of the appliance or main switch or fuse has not been activated	Activate the corresponding switch or fuse
	Boiler heating is open	Wait
The 85 °C thermal fuse is faulty. The dispenser's fuse is burned out	The thermostat switch of 60°C heating is faulty	Refer to the authorized local dealer or the manufacturer
	"Compartment heating" relay is faulty	
Dispenser's heating operates, but LED does not turn on	Faulty LED	Change LED
Pump motor does not operate	Main switch or fuse is not activated. The door is not closed.	Activate the main switch or fuse Close the door
	Main relay is faulty	Refer to the authorized local dealer or the manufacturer
	Pump motor is faulty	
	Program selection switch is faulty	
Motor operates, but pump does not rotate	An object has jammed the pump fin	Refer to the authorized local dealer or the manufacturer
	Salts or detergent have been petrified following non-operation of the appliance	Rotate the screw on the backside of the motor, until it rotates freely
Items do not dry (dishes, glasses, etc.)	Compartment has no drying aid	Insert drying aid to the compartment
	Drying valve is faulty	Refer to the authorized local dealer or the manufacturer
	Program switch is faulty	
	Rinsing arms do not rotate	
	Basket does not rotate	