



# COMMERCIAL ROTATING HEATED FOOD/PIZZA/PRETZEL DISPLAY MERCHANDISER

## Operating Instruction Manual



### Optional Accessories (sold separately)

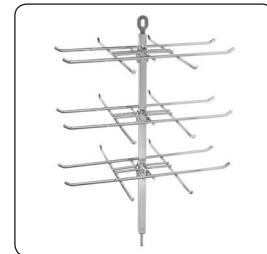

EDM-2PR



EDM-2PRS



EDM-2PZS



EDM-2  
Includes 14" round rack  
& a crumb tray

EDM-2PR	Pretzel Rack
EDM-2PRS	"Pretzels" Sign
EDM-2PZS	"Pizza" Sign

Model	Voltage	Power	Amperage	Plug Type	Overall Dimensions			Product Weight
					Length	Depth	Height	
EDM-2	120V ~ 60Hz	786W	7.2A	NEMA 5-15P	18" (457.2mm)	17" (431.8mm)	31" (787.4mm)	48.5 lbs 22 kgs

### BEFORE OPERATING ANY EQUIPMENT, READ AND FAMILIARIZE YOURSELF WITH THESE USE AND SAFETY INSTRUCTIONS

Congratulations on your purchase of this WINCO® commercial equipment. WINCO takes pride in the quality of its products. When used as intended and with proper care and maintenance, you will experience years of reliable operation from this equipment. To ensure best results, it is important that you read and follow the instructions in this manual carefully. **It's important to save these instructions for future reference.**

**COMMERCIAL ROTATING HEATED  
FOOD/PIZZA/PRETZEL DISPLAY MERCHANDISER**

## Important For Future Reference

Please complete this information and retain this manual for the life of the equipment. For Warranty Service and/or parts, this information is required.

\_\_\_\_\_

**Model Number**

\_\_\_\_\_

**Serial Number**

\_\_\_\_\_

**Date Purchased**



**WARNING: IMPROPER INSTALLATION, ADJUSTMENT, ALTERATION, SERVICE OR MAINTENANCE CAN CAUSE PROPERTY DAMAGE, INJURY, OR DEATH. READ THE INSTALLATION, OPERATION, AND MAINTENANCE INSTRUCTIONS THOROUGHLY BEFORE INSTALLING OR SERVICING THIS EQUIPMENT.**

**AVERTISSEMENT: TOUTE INSTALLATION, RÉGLAGE, MODIFICATION, RÉPARATION OU ENTRETIEN INCORRECT PEUT OCCASIONNER DES DOMMAGES MATÉRIELS, DES BLESSURES GRAVES OU LA MORT. LIRE LES INTRUCTIONS D'INSTALLATION, D'UTILISATION ET D'ENTRETIEN ATTENTIVEMENT AVANT D'INSTALLER OU DE RÉPARER CET APPAREIL.**



**CAUTION: THESE MODELS ARE DESIGNED, BUILT, AND SOLD FOR COMMERCIAL USE ONLY. IF THESE MODELS ARE POSITIONED SO THE GENERAL PUBLIC CAN USE THE EQUIPMENT, MAKE SURE THAT CAUTION SIGNS, WARNINGS, AND OPERATING INSTRUCTIONS ARE CLEARLY POSTED NEAR EACH UNIT SO THAT ANYONE USING THE EQUIPMENT WILL USE IT CORRECTLY AND NOT INJURE THEMSELVES OR HARM THE EQUIPMENT.**

**ATTENTION: CES MODÈLES SONT CONÇUS, FABRIQUÉS, ET VENDUS POUR UN USAGE COMMERCIAL SEULEMENT. SI CES MODÈLES SONT PLACÉS POUR QUE LE GRAND PUBLIC PUISSE LES UTILISER, ASSUREZ-VOUS QUE LES CONSIGNES D'ATTENTION, D'AVERTISSEMENT, ET LES INSTRUCTIONS D'UTILISATION SOIENT CLAIREMENT AFFICHÉES PRÈS DE CHAQUE UNITÉ DE SORTE QUE N'IMPORTE QUEL UTILISATEUR DE L'APPAREIL L'EMPLOIE CORRECTEMENT ET NE SE BLESSE PAS OU N'ENDOMMAGE PAS L'APPAREIL.**



**WARNING: A FACTORY AUTHORIZED SERVICE PROVIDER SHOULD HANDLE ALL MAINTENANCE AND REPAIR. BEFORE DOING ANY MAINTENANCE OR REPAIR, FOLLOW SERVICE SET UP ARRANGEMENT ON PAGE 15.**

**AVERTISSEMENT: UN TECHNICIEN AUTORISÉ PAR L'USINE DEVRA EFFECTUER TOUT L'ENTRETIEN ET LES RÉPARATIONS. AVANT DE FAIRE TOUT ENTRETIEN OU RÉPARATION, VEUILLEZ CONTACTER WINCO.**



## Introduction

Congratulations on the purchase of your WINCO equipment. Please take the time to carefully read through this manual to ensure the unit is operated and maintained properly, to ensure the best possible performance from this product for many years.

WINCO will not accept liability if:

- The instructions in this manual have not been followed correctly.
- Non-authorized personnel have tampered with the equipment.
- Non-original spare parts are used.
- The machine has not been handled and cleaned correctly.
- There is any use damage to the unit.

## Immediately Inspect for Shipping Damage

All containers should be examined for damage before and during unloading. The freight carrier has assumed responsibility for its safe transit and delivery. If equipment is received damaged, either apparent or concealed, a claim must be made with the delivering carrier.

- A. Apparent damage or loss must be noted on the freight bill at the time of delivery. It must then be signed by the carrier representative (Driver). If this is not done, the carrier may refuse the claim. The carrier can supply the necessary forms.
- B. If concealed damage or loss is not apparent until after equipment is uncrated, a request for inspection must be made to the carrier within 15 days. The carrier should arrange an inspection. Be certain to keep all contents and packaging material.

**COMMERCIAL ROTATING HEATED  
FOOD/PIZZA/PRETZEL DISPLAY MERCHANDISER**

## Table of Contents

Specifications.....	1
Warnings .....	2
Introduction .....	2
Packaging .....	3
Important Safeguards .....	4
Operation .....	6
Cleaning, Care & Maintenance .....	7
Safety Precautions .....	7
Troubleshooting .....	8
Service & Repair .....	8
Electrical Diagram .....	9
Exploded Views .....	10
Parts List .....	11
Limited Warranty .....	12

## Package Contents

In the box:

- (1) EDM-2 Commercial Rotating Heated Food/Pizza/Pretzel Display Merchandiser
- (1) 14" Diameter Round Rack
- (1) Crumb Tray
- (1) Operating Instruction Manual

WINCO prides itself on quality and service, ensuring that at the time of packing, all products are supplied fully functional and free of damage. Should you find any damage as result of freight, please contact your WINCO dealer immediately.

## Function and Purpose

This unit is intended for use in commercial food-service operations only. It is not intended for household, industrial or laboratory use.

**Please keep this manual in a safe place for future use!**

## NOTE

***Please remember that this manual and the warning labels do not replace the need to be alert, to properly train and supervise operators, and to use common sense when using this equipment.***

## Unpacking the Equipment

**DISPOSE OF ALL PACKAGING MATERIALS IN AN ENVIRONMENTALLY RESPONSIBLE MANNER.**

1. Remove all packing materials and tape, as well as any protective plastic and cardboard, from the unit.
2. Clean any glue residue left over from the plastic or tape.
3. Place the unit in the desired position and height.

**SAVE THE ORIGINAL BOX AND PACKAGING FOR USE IN PACKAGING AND SHIPPING THE EQUIPMENT IF SERVICES ARE NEEDED.**

## Important Safeguards

To ensure safe installation and operation, please carefully read and understand the following statements.

Unless the operator is adequately trained and supervised there is a possibility of serious injury. Owners of this equipment bear the responsibility to make certain that this equipment is used properly and safely, and to strictly follow all of the instructions contained in this manual and the requirements of local, state or federal law.



Owners should not permit anyone to touch this equipment unless they are over 18 years old, are adequately trained and supervised, and have read and understood this manual.

Owners should also ensure that no customers, visitors or other unauthorized personnel come in contact with this equipment. It is the responsibility of the owner and the operator to remain alert to any hazards posed by the function of this equipment.

If there is ever uncertainty about a particular task or the proper method of operating this equipment, ask an experienced supervisor or contact Winco® for assistance.

## Warnings

This manual contains a number of precautions to follow to help promote safe use of this equipment.

 <b>HOT</b>	<b>WARNING</b>  <b>AVERTISSEMENT</b>
	USE CAUTION WHEN TOUCHING THE UNIT. Ne touchez pas le liquide chaud ou les surfaces de chauffage lorsque l'appareil chauffe ou en fonctionnement.

### FOR YOUR SAFETY

Do not store or use gasoline or other flammable vapors and liquids in the vicinity of this or any other appliance.

### ESURE DE SECURITE

Ne pas entreposer ni utiliser d'essence ni autres vapeurs ou liquides inflammables a proximite de cet appareil ou de tout autre appareil!

### WARNING

Improper installation, adjustment, alteration, service or maintenance can cause property damage, injury or death.

Read these installation, operating and maintenance instructions thoroughly before installing or servicing this equipment.

### AVERTISSEMENT

L'installation, le réglage, la modification, la réparation ou l'entretien incorrect de cet appareil peut causer des dommages matériels, des blessures ou la mort. Lire attentivement les instructions d'installation, de fonctionnement et d'entretien avant de procéder a son installation ou entretien.

### TO PURCHASER

Contact your local gas supplier and ask for instructions in the event the user smells gas. This information should be posted in a prominent location.

### À L'ACHETEUR

Communiquez avec votre distributeur de gaz et informez vous quant aux procédés a suivre si vous détectez une odeur de gaz. Cette information doit être affichée a un endroit facile d'accès et très visible.

## Important Safeguards

These instructions should be followed at all times. Failure to follow these instructions could result in injury to yourself and others.

### TO REDUCE RISK OF INJURY OR DAMAGE TO THE UNIT:

1. Read this manual thoroughly before installation and operation. DO NOT proceed with installation and operation if you have any questions or do not understand anything in this manual. Contact your representative or the manufacturer first.
2. DO NOT touch any surfaces that may be hot.
3. Unplug from outlet when not in use prior to installing or removing parts and before cleaning. Allow for the device to cool first before handling.
4. To protect against the risk of electrical shock, do not immerse the appliance, cord or plug in water, or other liquids.

	<b>WARNING ⚠️ AVERTISSEMENT</b>	
	<b>Electrical Shock Hazard</b> Keep water and other liquids from entering the inside of the unit. Liquid inside the unit could cause an electrical shock.	<b>Risque de choc électrique</b> Conserver l'eau et d'autres liquides de pénétrer à l'intérieur de l'appareil. Liquide à l'intérieur de l'appareil pourrait provoquer un choc électrique.
	Do not spray water or cleaning products. Liquid could contact the electrical components and cause a short circuit or an electrical shock. Do not use unit if power cord is damaged or has been modified.	Ne pas pulvériser de l'eau ou des produits de nettoyage. Le liquide pourrait contacter avec les composants électriques et causer un court-circuit ou un choc électrique. Ne pas utiliser l'appareil si le cordon d'alimentation est endommagé, ou a été modifié.

5. DO NOT operate this device or any other electrical equipment with a damaged cord or plug, or after the unit malfunctions, is dropped or damaged in any manner. Return to the nearest WINCO Authorized Service Center for examination, repair and/or adjustment.
6. The use of accessory attachments not recommended by WINCO may cause fire, electric shock or injury.

	<b>WARNING ⚠️ AVERTISSEMENT</b>	
	<b>Fire Hazard.</b> Correct installation precautions, procedures and regulations must be followed. Operation and safety training is necessary for all users of this equipment.	<b>Risque d'incendie</b> La surchauffe des vapeurs d'huile ou de l'huile peut s'enflammer et provoquer un incendie. Surveillez la température, la qualité et le niveau d'huile. Utilisez et entretenez le système d'élimination des vapeurs d'huile.

7. Not intended for outdoor installation.
8. DO NOT let the cord hang over the edge of a table or counter, or touch hot surfaces.
9. DO NOT place on or near a hot gas / electric burner, or a heated oven.
10. This appliance should always be on a stable and steady countertop or table. Allow sufficient space around the cooking area. Never use the unit on/near low-heat-resistant materials (carpet, vinyl).

11. This appliance is not intended for use by individuals (including children) with reduced or impaired physical, sensory or mental capabilities, or lack of experience or knowledge, unless they have been given proper supervision or instruction concerning the use of this appliance by a person responsible for their safety.
12. Any objects that are not intended for use with the appliance should not be in the unit or placed in between the rack wires.
13. Clean with caution - if a wet sponge or cloth is used to wipe spills on a hot cooking surface, exercise caution to avoid steam burns. NOTE: some cleaners may produce noxious flames when applied to a hot surface.
14. Do not store any item on top of this unit when in operation.
15. Never place materials such as paper, cardboard, plastic, etc. on or under this unit.
16. Proper connections and power supply are essential for efficient performance.
17. If an extension cord power-supply is used,
  - a. The marked electrical rating of the extension cord should be rated the same or greater than the electrical rating of the unit.
  - b. The cord should be located so that it does not drape over the counter/tabletop and can not be damaged or moved unintentionally.
3. The units are wired to be used with a standard 120V/AC receptacle and may be plugged into any convenient outlet.
4. The installation of the unit must conform to the NATIONAL ELECTRIC CODE, ALL LOCAL ELECTRIC CODES AND ORDINANCES, AND ALL THE LOCAL ELECTRICAL COMPANY RULES AND REGULATIONS. Additionally, we recommend a 4" spacing surrounding the unit in order to provide adequate ventilation.

### Proper Grounding · Mise à la terre correcte

This machine is provided with a three-pronged grounding plug. The outlet to which this plug is connected must be properly grounded. If the receptacle is not the proper grounding type, contact an electrician. DO NOT, under any circumstances, cut or remove the third ground prong from the power cord or use any adapter plug.

*Cette machine est équipée d'une fiche à trois broches. La prise sur laquelle cette fiche est branchée doit être correctement mise à la terre. Si la prise n'est pas le type de mise à la terre, contactez avec un électricien. NE PAS, en aucun cas couper ou enlever la troisième broche de terre à partir du cordon d'alimentation ou utiliser un adaptateur.*

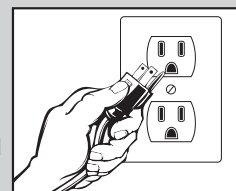

**USE A GROUNDED OUTLET  
DO NOT ADD AN ADAPTOR  
TO THE PLUG**

**UTILISER UNE PRISE AVEC MISE  
À LA TERRE NE PAS AJOUTER UN  
ADAPTEUR SUR LA FICHE**

## Operation

### EDM-2: Control Panel

- A - Motor Switch
- B - Light Switch
- C - Heat Switch
- D - Thermostat Dial
- E - Heat Indicator Light
- F - Temperature Display

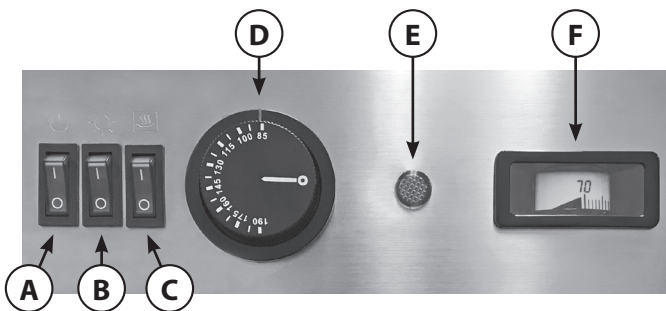

1. Plug in the power cord and install rack (if not already in).
2. If a low amount of humidity is desired, add water to the water pan located inside the front of cabinet.
3. Turn on switches for motor (A), light (B), or heat (C) - switches can be turned on/off independently.
4. Set the thermostat (D) to the desired heat temperature. The cabinet temperature will be shown on the temperature display (F).
5. Once preheated, open door. The rotating rack will stop and can then be manually turned as required for access.
6. Place food product (eg: pizza, pretzels, etc.) as desired onto the rack.
7. Refill water pan for low humidity as required.

**NOTE:** Drain the water pan before moving the unit to a new location.

### Removing / Installing the Round Rack or the Pretzel Rack

*Tools needed: Phillips Head Screwdriver*

1. Clean any food off the rack.
2. **TO REMOVE**, use a Phillips Head screwdriver to unscrew the bolt at top of rack.
3. Place nut and bolt aside for safe keeping.
4. Push rack upward slightly to free it from the bottom center alignment hole.
5. Tilt the rack toward door opening and remove rack from the unit.
6. **INSTALL** either the round rack or pizza rack, and resecure nut and bolt.

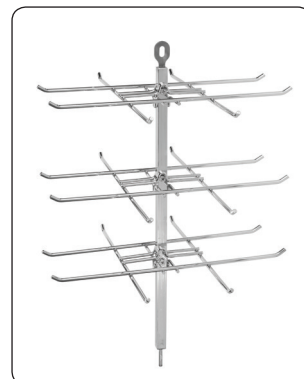
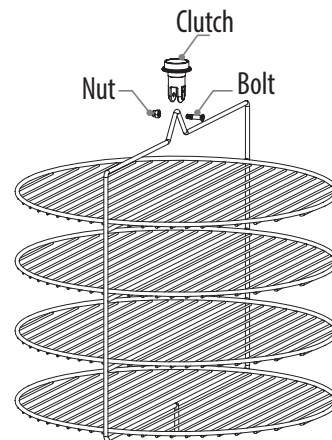

## Cleaning, Care & Maintenance

**To maintain the appearance and increase the service life, clean the heated merchandiser daily.**

**Clean all surfaces before using the appliance. Also clean after each day's operation; however, the unit may require more frequent cleaning, depending on the volume of production.**

- Switch power off and disconnect from the outlet before cleaning.
- Unplug the unit when not in operation.
- Allow merchandiser to cool before attempting to clean.
- The interior of the heated display merchandiser should be cleaned periodically with warm, soapy water and soft cloth.
- The exterior of the unit may be cleaned by carefully wiping with a damp cloth. OK to use glass cleaner on the glass.
- The rack is removable for easy cleaning.
- **DO NOT** immerse the unit in water.
- **DO NOT** clean with a pressure washer.

	<b>WARNING ⚠ AVERTISSEMENT</b>	
	<b>Burn Hazard.</b> When in operation, the appliance surfaces will be HOT! <i>Please take extreme caution.</i>	<b>Risque de brûlure.</b> En fonctionnement, les surfaces de l'appareil seront CHAUDES! <i>S'il vous plaît prendre une extrême prudence.</i>
<b>USE CAUTION WHEN TOUCHING THE UNIT.</b>	<b>Ne touchez pas le liquide chaud ou les surfaces de chauffage lorsque l'appareil chauffe ou en fonctionnement.</b>	

**WARNING: The interior of the unit will be hot after use.**

**Exercise caution when handling cooking utensils, cookware / pans.**

**NOTE: Proper cleaning instructions must be followed, otherwise operation of the unit may be seriously impaired.**

**Do not wash parts in an automatic dishwasher.**

## Removing Lime/Mineral Deposits

**NOTE: The amount of sediment content in the water will determine how often it will be necessary to delime.**

1. Switch the power to OFF and unplug power cord. Allow the unit to cool.
2. After the unit has cooled, drain the unit by removing the rack [as shown on page 6], then remove the reservoir and cover.
3. Drain any existing water from the reservoir and clean with warm soapy water. Wipe to dry before reinstalling.

## Safety Precautions

**Before installing and operating this equipment be sure everyone involved in its operation are fully trained and aware of all precautions. Accidents and problems can result from a failure to follow fundamental rules and precautions.**

- A WINCO® Approved Recommended Qualified Service Technician should carry out repairs if necessary. Do not remove any components or service panels on this product.
- Before handling, allow the equipment to cool after use.
- Before cleaning, switch off power and disconnect power cord from the outlet.
- **Do not immerse unit in water or use hose to clean.**  
**Ne jamais immerger l'appareil dans l'eau ni utilisez un jet d'eau pour le nettoyer.**
- If the power cord is damaged, it must be replaced by a WINCO® Approved Recommended Qualified Service Technician in order to avoid a hazard.

THIS EQUIPMENT MUST ONLY BE SERVICED BY AN AUTHORIZED AGENT.

## Troubleshooting

If your WINCO commercial equipment does not operate, please check the following prior to placing a service call.

PROBLEM	POSSIBLE CAUSE	RECOMMENDED SOLUTION
The unit is not turning on	Power supply	Check that the power supply cord is correctly plugged in and outlet is working.
	Power switch is in the "OFF" position	Check that the unit is correctly plugged in and turned on.
	Plug/cord or external/internal wiring is faulty	Check for loose wire connections and secure properly - <i>Replacement must be done by an authorized service provider.</i>
	Defective ON/OFF switch	Power off and replace ON/OFF switch - <i>Replacement must be done by an authorized service provider.</i>
The unit is on but not heating up	Temperature is set too low	Check that the unit is set to the correct temperature.
	Faulty heating element	Remove and replace - <i>Replacement must be done by an authorized service provider.</i>
	Incorrect voltage to heating element	Check input power for correct voltage - <i>Must be done by an authorized service provider.</i>
	High limit thermal disk is tripped/open	Turn unit off and allow it to cool down and reset.
Very low humidity in unit	Water tray is empty	Add water to tray.
	Air temperature is too low	Adjust the air temperature to higher setting
Rack is not spinning	Door is open	Check door is closed
	No power at the supply motor	Check for faulty door or motor switch If needed remove and replace door switch - <i>Replacement must be done by an authorized service provider.</i>
	Debris stopping the rack	Check and remove debris obstructing the rack from spinning
Light is not on	Light bulb burnt out	Remove and replace - <i>Replacement must be done by an authorized service provider.</i>
	Faulty light ballast	

## Service and Repair

THIS EQUIPMENT MUST ONLY BE SERVICED BY AN AUTHORIZED AGENT.

### NOTE

Parts protected by the manufacturer or its agent are not to be adjusted by the installer, unless the installer is an authorized service agent.

If you have any questions or problems DO NOT send unit to WINCO® without first contacting our customer service department.

See "Limited Warranty" section on page 12 for details.



## Electrical Diagram

MODEL: EDM-2

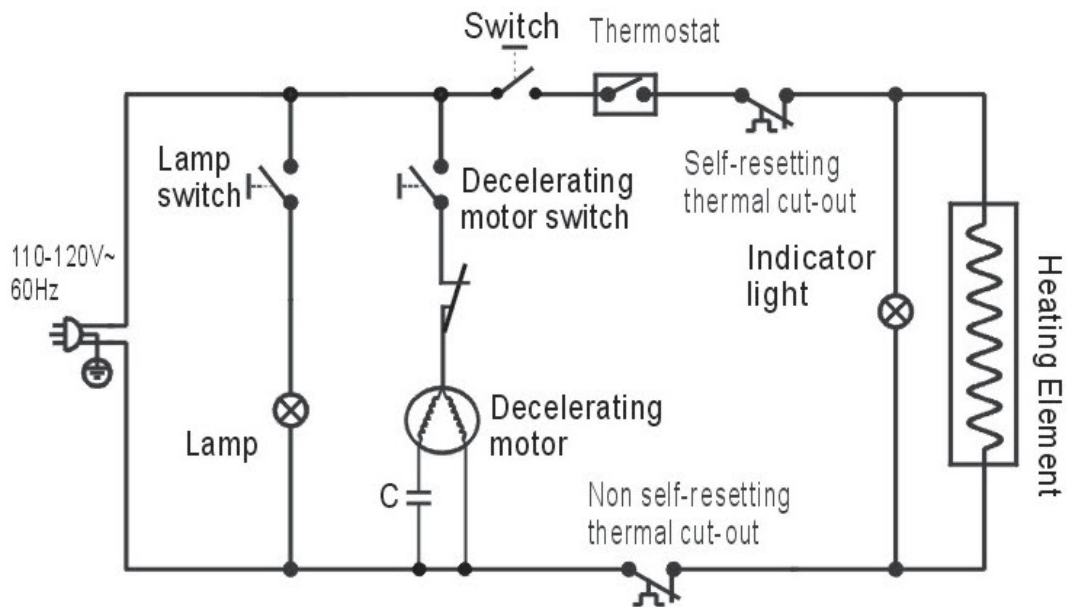

This circuit diagram has been provided to assist qualified electricians; only WINCO service agents or qualified electricians should carry out repairs if required.

Do not remove any components or service panels on this product.

## Exploded View

MODEL: EDM-2

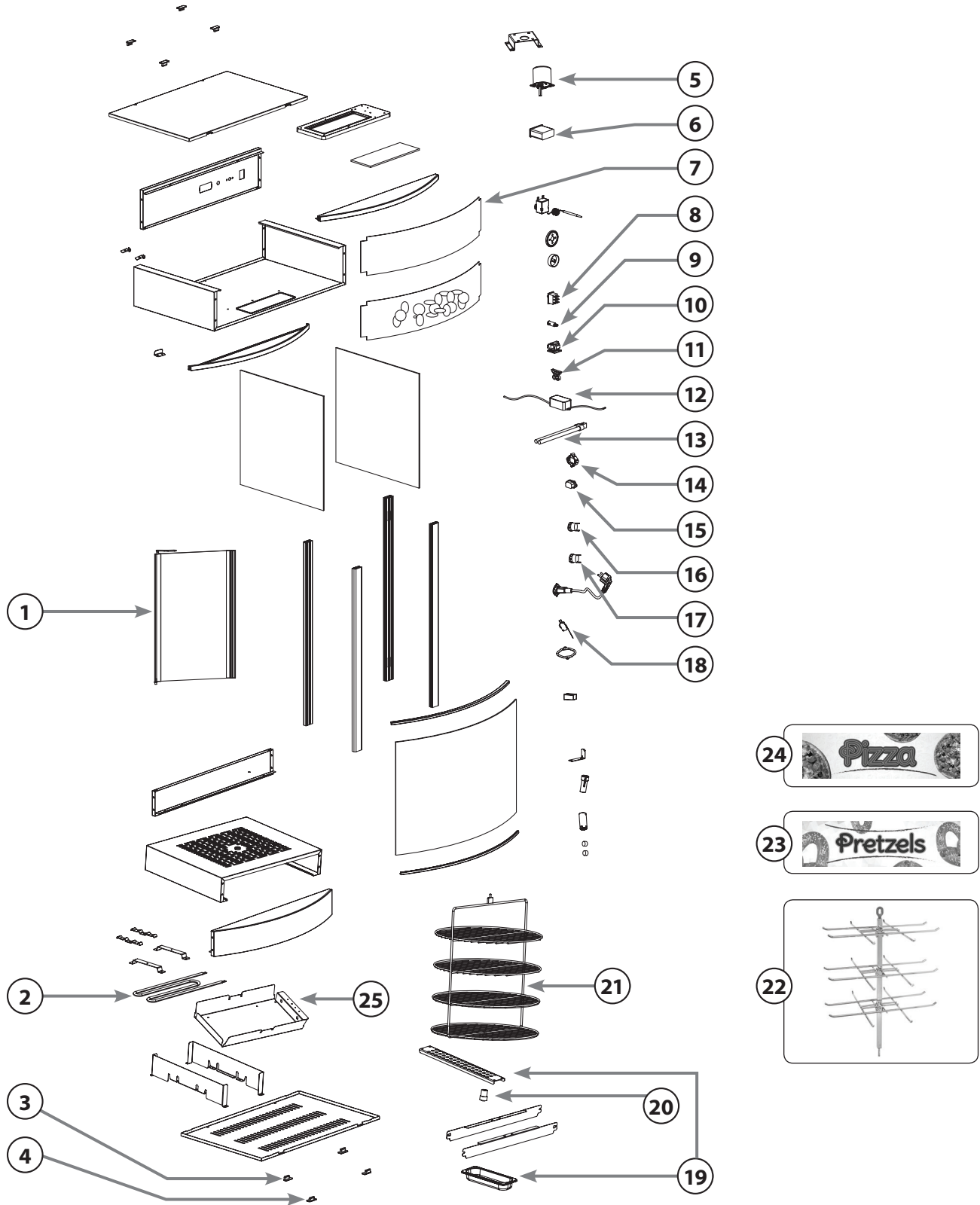

## Parts List

MODEL: EDM-2

#	Description	Part #
1	Door Assembly	EDM2-P19
2	Heating Element	EDM2-P3
3	Right Rubber Foot	EDM2-P2
4	Left Rubber Foot	EDM2-P1
5	Motor of Rotational Rack	EDM2-P4
6	Thermometer	EDM2-P5
7	Transparent Plate	EDM2-P6
8	Switch (Motor / Light / Heat)	EDM2-P9
9	Indicator Light	EDM2-P10
10	Lamp Holder	EDM2-P20
11	Lamp Bracket	EDM2-P21
12	Electronic Ballast	EDM2-P11
13	Top Horizontal LED Lamp	EDM2-P12
14	Socket Connector	EDM2-P22
15	Socket	EDM2-P23
16	Thermostat T1/33	EDM2-P13
17	Thermostat T1M/33	EDM2-P14
18	Rotational Switch	EDM2-P15
19	Water Tank with Cover	EDM2-P16
20	Rubber Guide for Rack	EDM2-P25
21	14" Dia Round Rack	EDM-P58
22	3-Level Pretzel Rack	EDM-2PR
23	Sign > Pretzels	EDM-2PRS
24	Sign > Pizza	EDM-2PZS
25	Crumb Tray	EDM2-P26
	Thermostat Assembly	EDM2-P7
	Motor/Clutch Assembly	EDM2-P24
	Motor	EDMN2-P27
	Spring	EDM2-P28
	Clutch - Upper	EDM2-P29
	Clutch - Lower	EDM2-P30
	Plastic Bearing	EDM2-P31

*Please contact factory  
for special order parts  
not listed.*



## Limited Warranty

WINCO® warrants to the original purchaser of new equipment that said equipment, when installed in accordance with our instructions within North America and subjected to normal use, is free from defects in material or workmanship for a period of 1 year. The labor warranty is one year from original installation or 18 months from actual factory shipment date, whichever date occurs first.

**THIS WARRANTY IS IN LIEU OF ALL OTHER WARRANTIES, WHETHER EXPRESSED OR IMPLIED. WINCO EXPRESSLY DISCLAIMS ANY IMPLIED WARRANTY OF MERCHANTABILITY OR EXPRESSED OR IMPLIED WARRANTY OF FITNESS FOR A PARTICULAR PURPOSE.**

**WINCO'S OBLIGATION AND LIABILITY UNDER THIS WARRANTY IS EXPRESSLY LIMITED TO REPAIRING AND REPLACING EQUIPMENT THAT PROVES TO BE DEFECTIVE IN MATERIAL OR WORKMANSHIP WITHIN THE APPLICABLE WARRANTY PERIOD.**

**IN NO EVENT SHALL WINCO BE LIABLE FOR INCIDENTAL OR CONSEQUENTIAL DAMAGES TO BUYER OR ANY THIRD PARTY, INCLUDING, WITHOUT LIMITATION, LOSS OF PROPERTY, PERSONAL INJURY, LOSS OF BUSINESS OR PROFITS OR OTHER ECONOMIC LOSSES, OR STATUTORY OR EXEMPLARY DAMAGES, WHETHER IN NEGLIGENCE, WARRANTY, STRICT LIABILITY, OR OTHERWISE.**

This warranty is given only to the first purchaser from a retail dealer. No warranty is given to subsequent transferees.

Warranty does not cover product failures caused by: failure to maintain, neglect, abuse, damage due to excess water, fire, normal wear, improper set up and use. Periodic maintenance is not covered.

This warranty is not in force until such time as a properly completed and digitally signed Installation/Warranty Registration has been received by WINCO within 30 days from the date of installation.

### WARRANTY SERVICE

To initiate warranty service

email: [EquipService@wincous.com](mailto:EquipService@wincous.com)

or call: **973-295-3899**

DO NOT send unit to WINCO® without first contacting our customer service department.

### REGISTER ONLINE AT:

[www.wincous.com](http://www.wincous.com)

Proof of purchase is required to extend warranty more than 1 year from date of shipment from the factory.

**THE FOREGOING WARRANTY PROVISIONS ARE A COMPLETE AND EXCLUSIVE STATEMENT BETWEEN THE BUYER AND SELLER. WINCO® NEITHER ASSUMES NOR AUTHORIZES ANY PERSONS TO ASSUME FOR IT ANY OTHER OBLIGATION OR LIABILITY IN CONNECTION WITH SAID EQUIPMENT.**

Examples of items not covered under warranty, but not limited to just these items:

1. Natural disasters (ie: earthquakes, tornadoes, hurricanes, etc.), fire, water damage, burglary, accident, theft.
2. Freight damage.
3. Improper installation or alteration of equipment.
4. Use of generic or after-market parts.
5. Repairs made by anyone other than a WINCO® designated service provider.
6. Lubrication.
7. Expendable wear parts, adjustable feet, blown fuses, lamps, etc.
8. Cleaning of equipment.
9. Misuse or abuse.

***Please keep this manual in a safe place for future use!***

Model: EDM-2

[www.wincous.com](http://www.wincous.com)