



COMPETITOR SERIES®

PROJECT: _____
 LOCATION: _____
 ITEM#: _____
 QUANTITY: _____



C-PP44-D-HC



C-PP67-D-HC



C-PP93-D-HC

PIZZA PREPARATION TABLES WITH DRAWERS

- Beautiful ergonomic construction & rounded corners
- Digital temperature controller and read-out
- All stainless steel exterior and interior
- Forced air refrigeration system
- Side mount compressor for enhanced efficiency
- 19^{1/2}" deep cutting board included
- Recessed drawer handles
- Pre-installed casters and shelving
- Drawers with stainless steel drawers slides and nylon wheels
- All Natural R290 Hydrocarbon Refrigerant
- US Department of Energy Certified
- Rail accomodates 4" deep pans
- Insulated lids help ensure food products in rail stay cold
- Migali® Protection Plan: 2 Year Parts & Labor Warranty, 5 Years Compressor Warranty

MODEL	DRAWERS	NUM. OF (1/3) SIZE PANS*	CAPACITY CU/FT	SHELVES	H/P	AMPS	VOLTAGE	ENERGY CONSUMPTION KWH/24 HR	PLUG TYPE	TEMP RANGE	EXTERIOR DIMENSIONS W X D X H**	INTERIOR DIMENSIONS W X D X H	PACKAGED DIMENSIONS W X D X H**	WEIGHT	PACKAGED WEIGHT
C-PP44-D-HC	2	6	9.7	1	1/7+	2.3	115/60/1	1.5	Nema 5-15P	+33° F (~) +41° F	44 x 33 x 43.4	40.4 x 26.4 x 26.3	47 x 35 x 46	238 lbs.	295 lbs.
C-PP67-D-HC	4	9	18.5	2	1/5	2.8	115/60/1	2.1	Nema 5-15P	+33° F (~) +41° F	67 x 33 x 43.4	63.5 x 26.4 x 26.3	68 x 35 x 46	335 lbs.	405 lbs.
C-PP93-D-HC	6	12	28.4	3	1/4+	3.1	115/60/1	2.6	Nema 5-15P	+33° F (~) +41° F	93 x 33 x 43.4	89.4 x 26.4 x 26.3	95 x 35 x 46	427 lbs.	527 lbs.

* Pans are not included

** Height is measured floor to the top of the pan rail and include 6" casters

Removal of pan rail lids during operation will compromise the performance of the Pizza Prep Table.

FOR COMMERCIAL USE ONLY

NOTE: MIGALI® RESERVES THE RIGHT TO CHANGE SPECIFICATIONS WITHOUT NOTICE



TOLL FREE: 800.852.5292
 WEB: www.migali.com



DIMENSIONAL DRAWINGS

C-PP44-D-HC

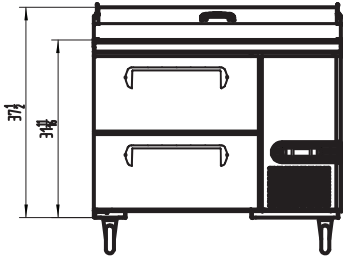

C-PP67-D-HC

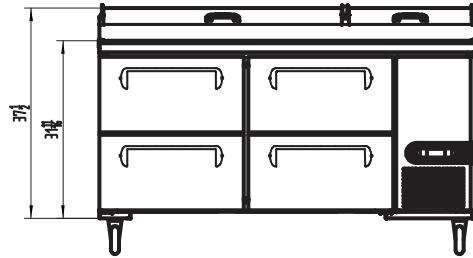

C-PP93-D-HC

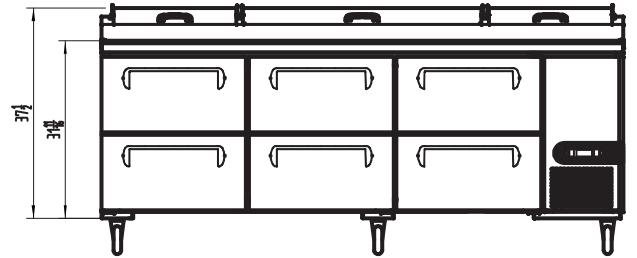

C-PP44-D-HC
TOP VIEW

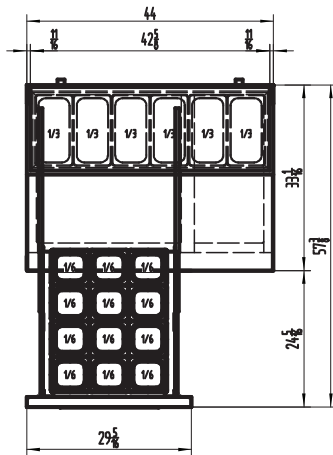

C-PP67-D-HC
TOP VIEW

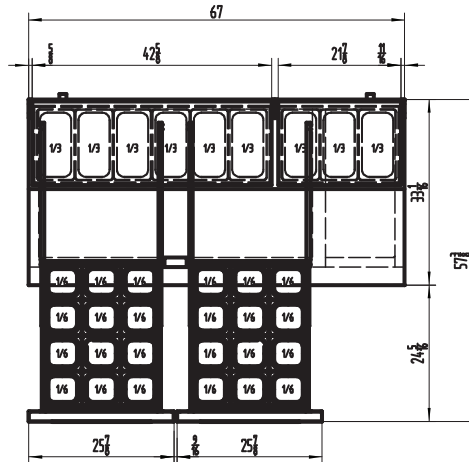

C-PP93-D-HC
TOP VIEW

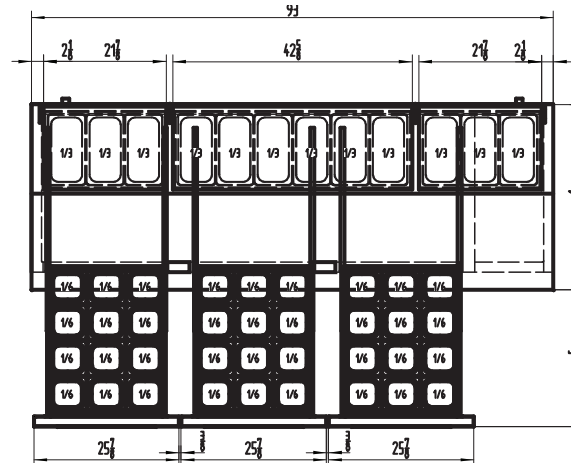

SIDE VIEW (2, 4, 6 DRAWER)

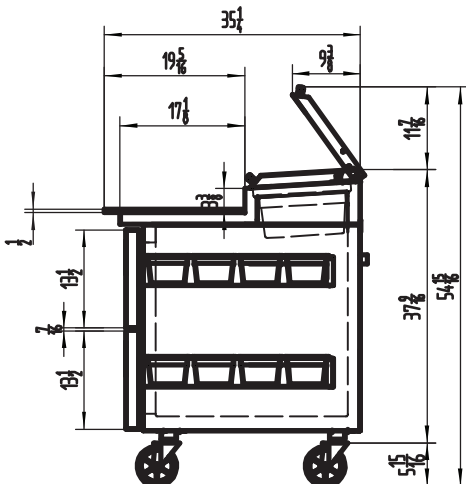

MIGALI® REMAINS AN AMERICAN FAMILY COMPANY SINCE 1955