

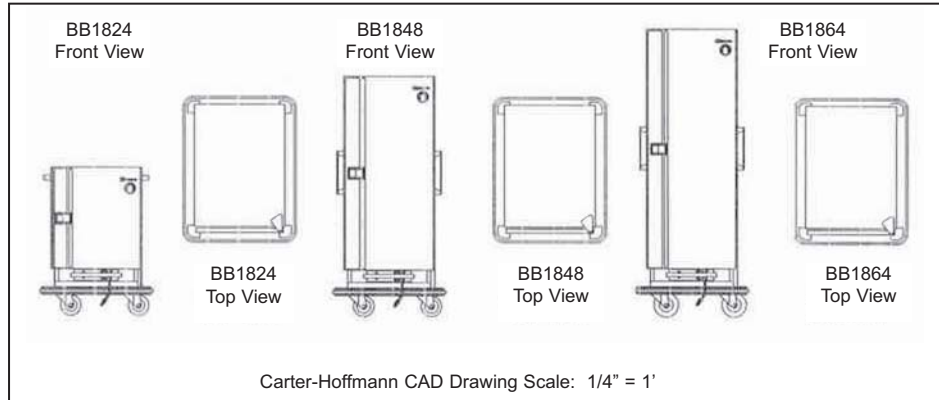

BB1824, BB1848 & BB1864 CONVERTIBLE BANQUET CARTERS for Pre-plated Banquet Meals, Trays and Pans

CARTER-HOFFMANN
B11
HEATED SERVERS
FOOD SERVICE EQUIPMENT



Carter-Hoffmann CAD Drawing Scale: 1/4" = 1'

Model Number	Capacity*			Number of Shelves	Clearance Between Shelves in (mm)	Shelf Size in (mm)	Overall Dimensions						Caster		Shipping Weight		
	Plates Up to 11" dia.	Trays 18"x26"	Pans 2.5" deep 12"x20"				Height			Depth		Width		Diameter		lbs	kg
							in	mm	in	mm	in	mm	in	mm			
<input type="checkbox"/> BB1824	24	6	12	2	9 1/2 (241)	20 3/4 x 26 (527 x 660)	36	914	36	914	30 5/8	778	5	127	290	132	
<input type="checkbox"/> BB1848	48	10	20	3	12 1/2 (318)	20 3/4 x 26 (527 x 660)	58	1473	36	914	30 5/8	778	5	127	355	161	
<input type="checkbox"/> BB1864	64	12	24	4	12 1/2 (318)	20 3/4 x 26 (527 x 660)	71	1803	36	914	30 5/8	778	6	152	410	186	

* Tray slides accommodate wire plate shelves, pans and trays for combination use. Tray slides are adjustable in 1-3/4" increments. Plate capacity depends on stacking height of plates and covers (see "Clearance Between Shelves"). Maximum diameter includes cover. Also accommodate 2/1 and 1/1 Gastronorm pans.

CONSTRUCTION... Completely welded cabinet construction with outer cabinet formed and welded to base. All seams turned in to eliminate raw edges.

CABINET MATERIAL... All stainless steel construction; 20 gauge polished exterior and 24 gauge interior.

BASE FRAME... 12 gauge stainless steel full depth caster bolsters with 14 gauge stainless steel channels welded to bolsters.

CASTERS... 5" or 6" diameter, industrial grade caster with polyurethane tread. Sealed roller axle bearing and double ball bearing swivel. Plate mounted and bolted to base in offset "wheel ahead" pattern. Two casters fitted with brakes.

BUMPER... Non-marking gray vinyl bumper set in heavy-duty 3/16" thick extruded aluminum frame with reinforced corner cutouts.

INSULATION... 1" thick high density continuous wrap-around type fiberglass insulation with 1-1/2" thickness on top.

DOOR... Welded double panel stainless steel door. Filled with 1" thick fiberglass insulation. Decorative red vinyl door stripe.

HINGES... Concealed stainless steel hinges with 5/16" pin.

GASKET... High temperature silicone gasket withstands high temperatures.

PUSH HANDLES... Two 1" diameter stainless steel tubular handles bolted to cabinet.

LATCH... Flush mounted heavy-duty sliding latch with exclusive grip handle.

SHELVES... Welded, duplex nickel-plated removable wire shelves.

PAN/TRAY RACK ASSEMBLIES... Removable stainless steel tray rack assemblies. Removable stainless steel universal slides, fully adjustable on 1-3/4" centers. Standard spacing at 3-1/2".

THERMOMETER... Dial type with remote sensing bulb and sensing bulb protector. Mounted to door.

HEATING SYSTEM... Bottom mounted heater. Stainless steel construction. Removable without tools. 1600 watt inconel-sheathed heating element. High impedance protected, internally cooled fan motor. Full range thermostat and power indicating light.

ELECTRICAL CHARACTERISTICS... Operates on 120 volts, 60 cycle, single phase, 1650 watts, 13.7 amps. Ten foot rubber cord with 3 prong grounding plug. NEMA 5-15P.

PERFORMANCE... Capable of heating to 200° F (94° C). Preheat to 160° F (71° C) in approximately 25 minutes.

ACCESSORIES/OPTIONS...

- Canned fuel holders
- Top mounted transport latch
- Locking paddle latch
- Menu card holder
- Lexan thermometer cover
- 4 wheel brakes
- Alternate caster sizes and types
- Alternate electrical configurations
- Passive humidity pan
- Cold plate

Specifications subject to change through product improvement & innovation.



CARTER-HOFFMANN
1551 McCormick Ave., Mundelein, IL 60060
(847) 362-5500 • (800) 323-9793 • Fax (847) 367-8981
www.carter-hoffmann.com

SPECIFICATIONS

Printed in U.S.A. B20 0723
Carter-Hoffmann is a trademark of Carter-Hoffmann, LLC

FEATURES & BENEFITS

BB1824, BB1848 & BB1864 CONVERTIBLE BANQUET CARTERS

Since 1947, Foodservice Equipment That Delivers!

DOUBLE WALL STAINLESS STEEL CABINET... Strongest, most durable materials for long life. High density fiberglass for maximum heat retention.

VERSATILE HOLDING... Each cabinet comes with a full set of adjustable shelves and tray slides to accommodate holding of plated and/or bulk food.

HEAVY-DUTY STAINLESS STEEL BASE FRAME... 12 gauge caster bolsters with perimeter frame for rugged use and added durability.

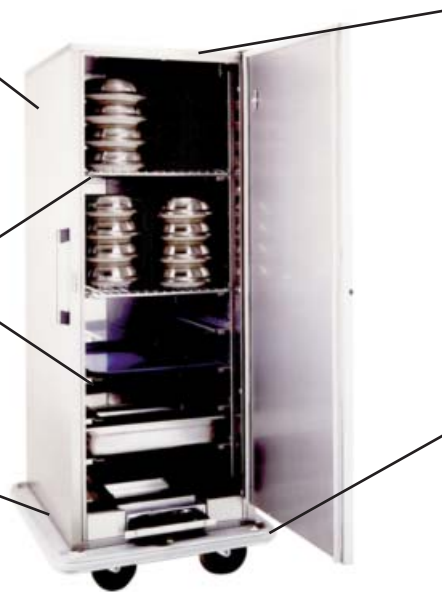

BB1864

COMPLETELY WELDED TURNED-IN SEAM CONSTRUCTION... Adds rigidity and strength to entire cabinet for long life and eliminates raw edges for ease of cleaning and safety.

SPACE-SAVING DESIGN... Upright design of cabinets uses vertical space for smaller footprint.

HEAVY-DUTY NON-MARKING BUMPER... Set in 3/16" thick extruded aluminum frame with reinforced corner cut-outs. Protects doorways, walls and cart from damage.

POLYURETHANE TREAD CASTERS WITH SEALED ROLLER BEARING... Long lasting and easy rolling for maximum load and minimum maintenance.



OFFSET "WHEEL AHEAD" PATTERN... Only one wheel can pass over uneven surfaces at a time for easy handling and steering.



FLUSH-MOUNTED SLIDING DOOR LATCH WITH GRIP HANDLE... Designed for transport applications. Door remains closed during transport. Flush design protects cart from damage.



CONCEALED STAINLESS STEEL HINGE WITH 5/16" PIN... Keeps doors properly aligned and withstands rugged use.



HIGH PERFORMANCE HEATER... Blower system for fast heat up, recovery and even heat distribution throughout cabinet. Unit is removable without tools for easy cleaning.

1551 McCormick Avenue, Mundelein, Illinois 60060
Tel. (847)362-5500 • (800)323-9793 • Fax (847)367-8981
www.carter-hoffmann.com



NSF/ANSI 4