



YOU CAN TRUST

FOOD PROCESSOR

PA7 PRO



## STANDARD FEATURES



### HIGHER CLEARANCE

New feed hopper locker allows operator to open and close feed hopper with ease.



### HIGHER CLEARANCE

Allows for the use of up to 7 3/4" deep receiving pans.



### EXTRA LARGE FEED HOPPER

For big products or large quantities.



### PUSHER PLATE WITH ROUND CHUTE

Allows long and round products to be cut with precision.



### USER SAFETY

Double interlock switch prevents machine from running when feed hopper is open or pusher plate is up.



### EASILY REMOVABLE FEED HOPPER

Easy clean up.



PA7 PRO

Stainless steel construction, effortless precise cuts, high productivity and a wide selection of discs, including Dicing and Julienne, [sold separately], make the PA7 PRO the best cost x benefit unit on the market.

ILLUSTRATIVE PHOTO, ACTUAL PRODUCTS AND ACCESSORIES ARE SUBJECT TO CHANGE WITHOUT NOTICE.



**Skyfood Equipment LLC**  
175 SW 7th Street, Ste 2416  
Miami, FL 33130

**Toll Free:**  
1-800-503-7534  
sales@skyfood.us

[www.skyfood.us](http://www.skyfood.us)



Follow us to keep up to date with the later news and offers

/SkyfoodEquipment

/SkyfoodEquipment

/SkyfoodEquipment







YOU CAN TRUST

# FOOD PROCESSOR

## PA7 PRO

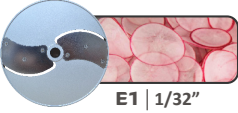
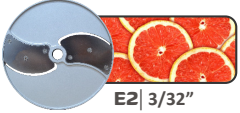

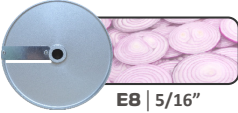
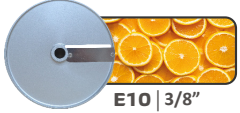

### SLICING DISCS

 E1   1/32"	 E2   3/32"	 E3   1/8"	 E5   3/16"
 E8   5/16"	 E10   3/8"	 E14   9/16"	

### JULIENNE

 H1.5   1/16"	 H3   1/8"	 H7   9/32"	 H10   3/8"
---	--	--	---

### SHREDDING DISCS

 Z3   1/8"	 Z5   3/16"	 Z8   5/16"
---	--	--



### GRATING DISC

 V
--





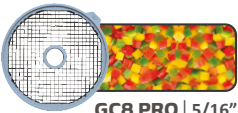



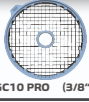

### SCALLOP CUT

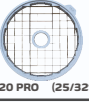
 W3   1/8"
---

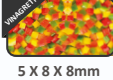
### DICING GRIDS

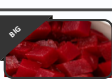

 GC8 PRO   5/16"	 GC10 PRO   3/8"	 GC14 PRO   9/16"	 GC20 PRO   25/32"
--	--	--	--

### COMBINATIONS





	 GC8 PRO (5/16")	 GC10 PRO (3/8")	 GC14 PRO (9/16")	 GC20 PRO (25/32")
 E5 3/16"	 Tomato 5 X 8 X 8mm	5 X 10 X 10mm	5 X 14 X 14mm	5 X 20 X 20mm
 E8 5/16"	 Cucumber 8 X 8 X 8mm	8 X 10 X 10mm	8 X 14 X 14mm	8 X 20 X 20mm
 E10 3/8"	Do not use a slicer disc	 Onion 10 X 10 X 10mm	10 X 14 X 14mm	10 X 20 X 20mm
 E14 9/16"	Do not use a slicer disc	Do not use a slicer disc	 Tomato 14 X 14 X 14mm	 Cucumber 14 X 20 X 20mm

Convenient 3 and 6 blade packages are available with pre-selected discs.

### KIT MP-3

 E3   1/8"	 E5   3/16"	 Z5   3/16"
--	---	---

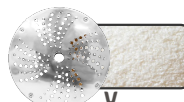
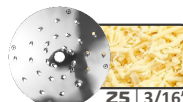
### KIT MP-6 PRO

 E3   1/8"	 E14   9/16"	 H10   3/8"
 V	 Z5   3/16"	 GC14 PRO   9/16"



**Skyfood Equipment LLC**  
175 SW 7th Street, Ste 2416  
Miami, FL 33130

Toll Free:  
1-800-503-7534  
sales@skyfood.us

[www.skyfood.us](http://www.skyfood.us)



Follow us to keep up to date with the later news and offers

 /SkyfoodEquipment

 /SkyfoodEquipment

 /SkyfoodEquipment

ILLUSTRATIVE PHOTO, ACTUAL PRODUCTS AND ACCESSORIES ARE SUBJECT TO CHANGE WITHOUT NOTICE.



YOU CAN TRUST

# FOOD PROCESSOR

## PA7 PRO



### DICING ASSEMBLY



### DIMENSIONS

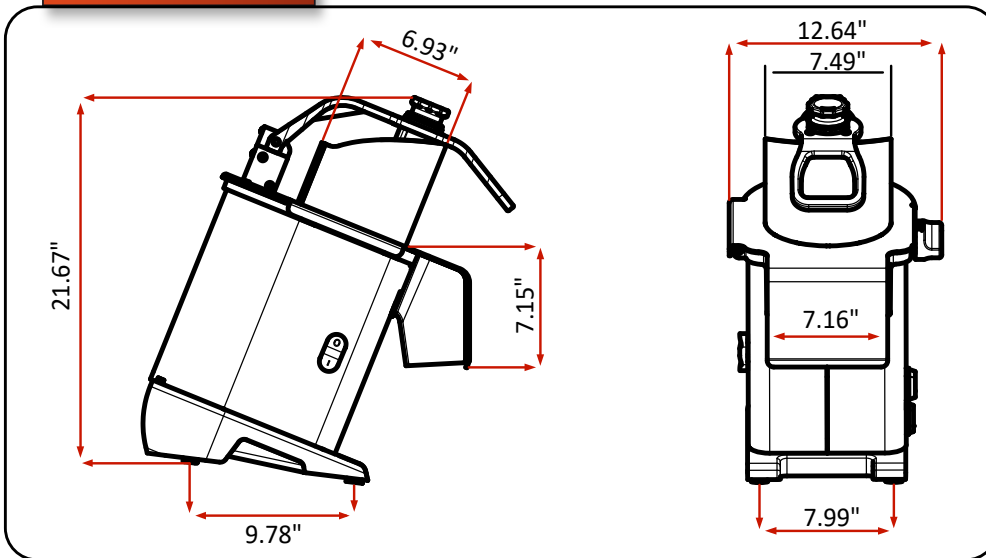

**MADE IN BRAZIL**

**HIGH POWER**  
1/2 HP Motor

**PLUG**  
NEMA 5-15P

**WARRANTY 01 YEAR PARTS AND LABOR VALID IN THE CONTINENTAL UNITED STATES.**

Item	Voltage	AMPS	Power Rating	Dimensions (W x D x H)	Weight (Net x Ship)	Oblong Dimensions	Round Chute Diameter	Disc Diameter	Production
PA7PRO	110 V	5.5	1/2 HP	11 3/16" x 20 7/8" x 20 1/2"	50 lb x 58 lb	7 3/8" x 6 1/4"	1 7/8"	8"	552 lb/h



**Skyfood Equipment LLC**  
175 SW 7th Street, Ste 2416  
Miami, FL 33130

**Toll Free:**  
1-800-503-7534  
sales@skyfood.us

[www.skyfood.us](http://www.skyfood.us)



Follow us to keep up to date with the later news and offers

/SkyfoodEquipment

/SkyfoodEquipment

/SkyfoodEquipment

ILLUSTRATIVE PHOTO, ACTUAL PRODUCTS AND ACCESSORIES ARE SUBJECT TO CHANGE WITHOUT NOTICE.