

HSM Series

Heated Shelf Merchandiser



HSM-24/3S/T & HSM-24/5S/T

UL

Featuring exclusive Halo Heat® technology, Alto-Shaam heated shelf merchandisers provide precise, top and bottom heat for the highest quality prepared food— and longer hold times.

Hold a variety of grab-and-go products, including rotisserie chickens, pizza, sandwiches, and more. Drive foodservice profits with hot, ready-to-eat meals. Convenient, fresh meals are displayed in an aesthetically pleasing, customizable merchandiser.

Experience better quality food with gentle, even and precise Halo Heat® fanless technology to keep food from drying out.

Flexibility to control individual shelf temperatures allows you to hold a variety of products at the proper temperature.

Boost impulse sales with LED-lighted shelves, customized branding, backlit interchangeable graphics, pricing rails and window sides.

Simple operation and easy cleaning keeps delis and grab-and-go areas operating smoothly.

Easy-to-load shelves – pass-through option available for added convenience.

Made in the USA with a commitment to quality. Alto-Shaam is ISO 9001:2015-certified.

Standard Features

- Adjustable thermostat per shelf with a heat-on indicator light
- Latched access panel on the front of the merchandiser
- Four casters for floor models
- Four adjustable feet for countertop model



HSM-24/5S/T



HSM-24/3S/T

Configurations (select one)

Model

- HSM-24/3S/T
- HSM-24/5S/T

Electrical

- 120V, 1PH (HSM-24/3S/T only)
- 208–240V, 1PH

Door Options

- None (reach-in models only)
- Rear slide (pass-through models only)
- Rear swing (pass-through models only)
- Front swing (reach-in and pass-through models)

Legs or Casters (floor standing)

- 4–6" (102–153mm) adjustable legs [5025454]
- 3" (76mm) casters (Standard)

Legs or Display Base (countertop)

- 4–6" (102–153mm) adjustable legs: [Standard] [5026182]
- HSM-24/3S-CT Display Base, with casters [5026172]
- HSM-24/3S-CT Display Base, with legs [5026180]

Accessories (select all that apply)

qty

Note: Unit ships without graphics unless selected

- Signage panel, POP Display
- Signage panel, shelf – Rotisserie Chicken
- Signage panel, shelf – Hot Sandwiches
- Signage panel, shelf – Barbecue Ribs
- Signage panel, shelf – Hot & Tasty
- Signage panel, shelf – Grab & Go
- Signage panel, shelf – Hot & Fresh
- Shelf insert for magnetic signage panels, HSM-24/5S [1027304].
Magnetic signage panels to be provided by customer.



CAPACITY

18 HSM-24/3S/T
Three (3) 20-7/8" [530mm] width shelves,
Fifteen (15) sandwiches or
Six (6) chicken boats with dome cover per shelf.

30 HSM-24/5S/T:
Five (5) 20-7/8" [530mm] width shelves,
Fifteen (15) sandwiches or
Six (6) chicken boats with dome cover per shelf.



WEIGHT

HSM-24/3S/T: 48 lb [21 kg] 16 lb [7 kg] per shelf

HSM-24/5S/T: 80 lb [35 kg] 16 lb [7 kg] per shelf



HSM Series

HSM-24/5S/T

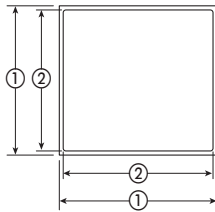

Shelf Dimensions (W x D)

① = Overall ② = Heated Surface

① 20-7/8" x 20-5/8" (528mm x 523mm)

② 19-7/8" x 19-5/8" (503mm x 498mm)

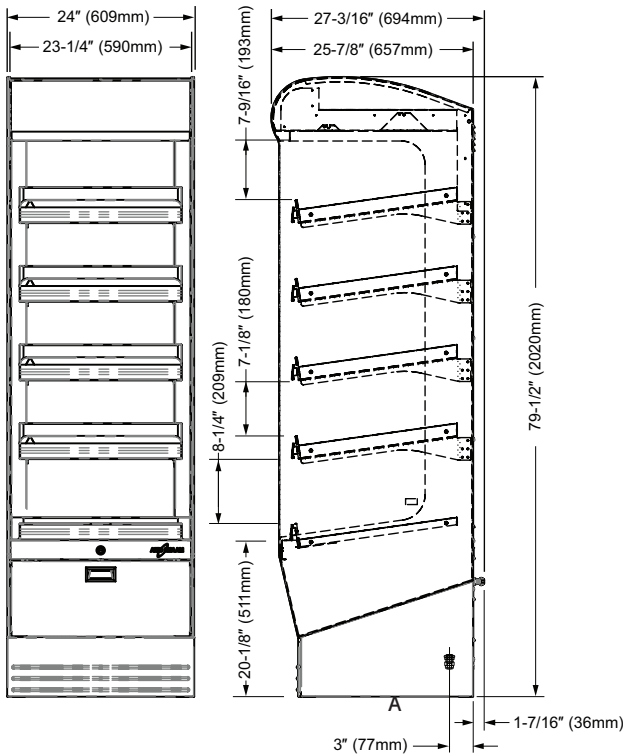
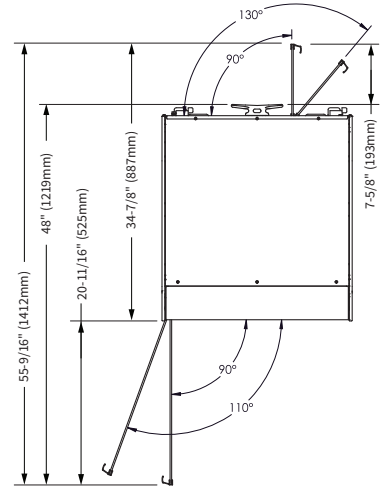

A: ELECTRICAL CONNECTION

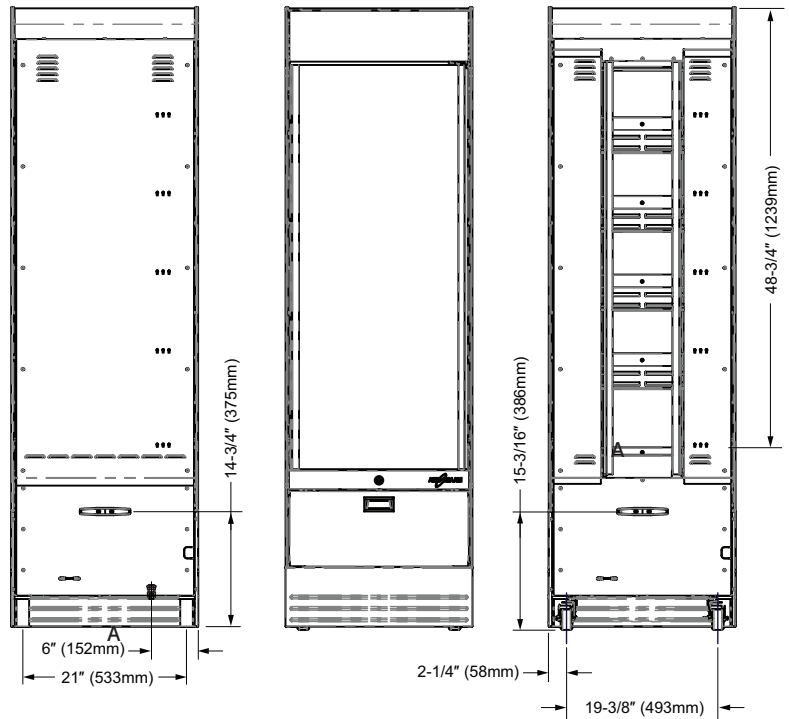

Model

HSM-24/5S/T

Exterior (H x W x D)

79-1/2" x 24" x 27-3/16" [2020mm x 609mm x 694mm]

Net Weight

406 lb [184 kg]

Ship Dimensions (L x W x H)*

HSM-24/5S/T

36" x 36" x 89" [914mm x 914mm x 2261mm]

Ship Weight*

550 lb [249 kg]

*Domestic ground shipping information.

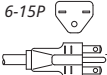

HSM-24/5S/T	V	Ph	Hz	Awg	IEC	A	Breaker [A]	kW	Plug Configuration Options
208-240V	208	1	50/60	10	—	10.4	15	2.16	9' Cord NEMA 6-15P 
	240	1	50/60	10	—	11.9	15	2.86	

Electrical connections must meet all applicable federal, state, and local codes. Dedicated circuit required.

HSM Series

HSM-24/3S/T

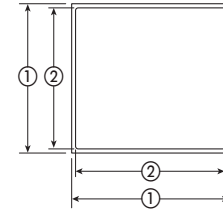
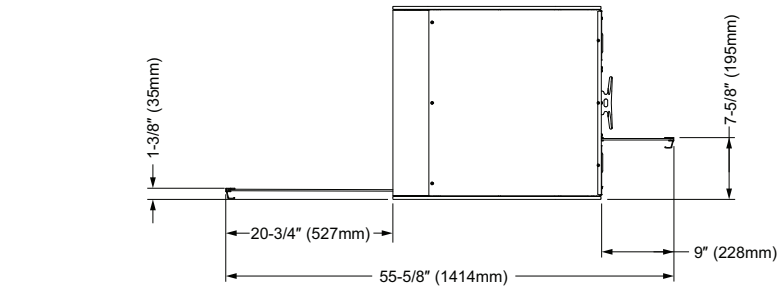

Shelf Dimensions (W x D)

① = Overall ② = Heated Surface

① 20-7/8" x 20-5/8" (528mm x 523mm)

② 19-7/8" x 19-5/8" (503mm x 498mm)

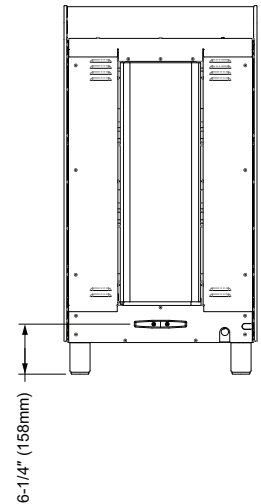
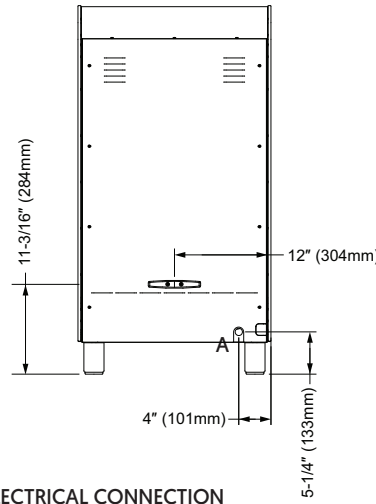
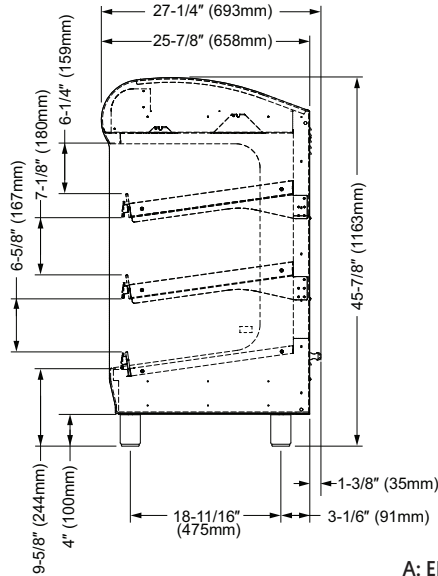
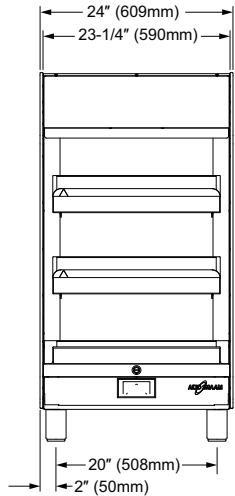

A: ELECTRICAL CONNECTION

Model	Exterior (H x W x D)
HSM-24/3S/T	45-7/8 x 24" x 27-1/4" [1163mm x 609mm x 693mm]
	Ship Dimensions (L x W x H)*
HSM-24/3S/T	36" x 36" x 65" [914mm x 914mm x 1651mm]

Net Weight
250 lb [113 kg]
Ship Weight*
300 lb [136 kg]

*Domestic ground shipping information. Contact factory for export weight and dimensions.



Rear: 4" [102mm]

Recommended: 18" [457mm] for service access. Charges associated with inadequate service access are not covered under warranty.



- Merchandiser must be installed level.
- Merchandiser must not be installed in any area where it may be affected by steam, grease, dripping water, high temperatures, or any other severely adverse conditions.



HSM-24/3S/T	V	Ph	Hz	Awg	IEC	A	Breaker [A]	kW	Plug Configuration Options
120V	120	1	60	12	—	7.1	18	1.7	6' Cord NEMA 5-20P
208-240V	208	1	50/60	12	—	6.23	9	1.3	6' Cord NEMA 6-15P
	240	1	50/60	12	—	7.15	9	1.7	

Electrical connections must meet all applicable federal, state, and local codes. Dedicated circuit required.

CONTACT US

W164 N9221 Water Street | Menomonee Falls, Wisconsin 53051 | U.S.A.
 Phone: 262.251.3800 | 800.558.8744 U.S.A./Canada | Fax: 262.251.7067 | alto-shaam.com