



DUKERS
Quality Commercial Refrigeration



REACH IN REFRIGERATOR

D55AR

Top Mounted / 2-Solid Door













i TECHNICAL SPECIFICATIONS

Voltage/Frequency 115V/60Hz
Refrigerant R290
Type of Defrost Automatic
Interior Material Stainless Steel
Exterior Material Stainless Steel
Temperature Range °F 33 ~ 41°F
Compressor Power (HP) 1/2+
Nema Config. NEMA5-15P



PRODUCT FEATURES

-  Equipped with Locking Doors
-  The compressor is mounted in the top and placed in the coolest possible area; this makes it easily accessible for servicing.
-  Digital temperature controls with LED display for precise adjustment and automatic defrosting system.
-  Temperatures in the cabinet range from 33 to 41 degrees Fahrenheit
-  Self closing doors with stay open feature.
-  R290 Natural Refrigerant promotes faster cool down and efficient energy consumption.
-  Epoxy coated wire shelves.
-  Stainless steel interior & exterior, sealed interior floors, and rounded cabinet corners for easy cleaning.
-  High quality coated stainless adjustable shelves prevent peel and rust.
-  Lifetime warranty on hinges.
-  Adjustable front locking casters.



**HIGH QUALITY
STAINLESS STEEL &
ROBUST DESIGN**



DUKERS

Los Angeles | San Francisco | Dallas
Houston | Florida | Chicago | New Jersey

 1-800-931-8628

 info@dukersusa.com

www.DukersUSA.com

DETAILS & SPECIFICATIONS

D55AR

Front View

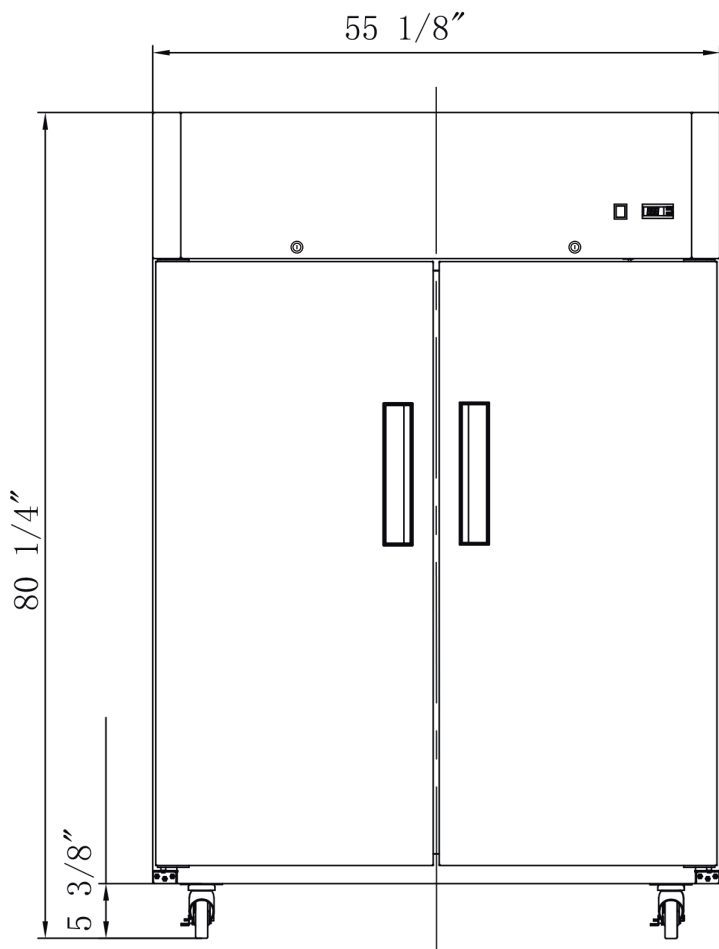

Side View

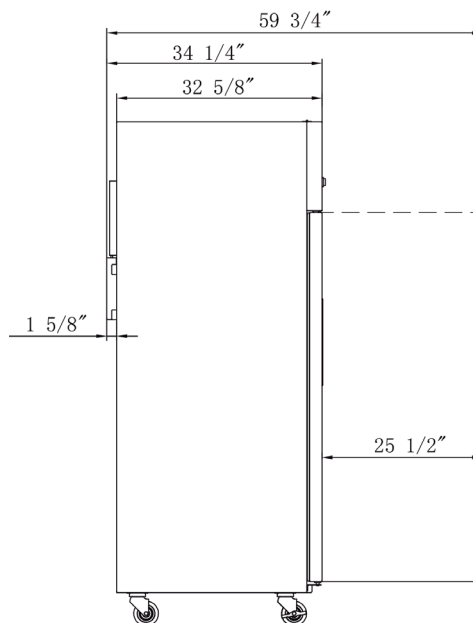

MODEL D55AR

Rated Voltage	115V
Rated Frequency	60Hz
Total Input Power	730W
Total Current	8.6A
Total Capacity	41.73 cu ft
Climatic Category	4-5
Protection Type	I
Design Pressure High Side	300 PSIG
Design Pressure Low Side	150 PSIG
Insulation Blowing Gas	C-Pentane
Refrigerant	R290/4.58 oz

MODEL	EXTERNAL DIMENSION WXDXH (INCHES)	PACKAGING DIMENSION WXDXH (INCHES)	PRODUCT NET WEIGHT	# OF SHELVES	40HQ CONTAINER CERT.
D55AR	55 1/8 x 34 1/4 x 80 1/4	57 1/8 x 35 1/4 x 82 1/4	463 lbs	8	16



Los Angeles | San Francisco | Dallas
Houston | Florida | Chicago | New Jersey

1-800-931-8628

@ info@dukersusa.com

www.DukersUSA.com