

DOUBLE OVERSHELVES

Models: DOS27, DOS32, DOS36
DOS48, DOS60, DOS72

DOS - Double Overshelves for Worktops & Sandwich Units

Heavy-duty, stainless steel, tubular-style, pass-thru overshelves cantilever to rear of Worktop or Sandwich Unit models. Standard with "hat channel" under each shelf for field-added components.



Bottom shelf adjustable to 19", 21" or 23" in height

Standard with "hat channel" under each shelf

Model Features

Pass-thru shelving

Heavy-gauge stainless steel, tubular-style poles, 1 1/4" square, .083 wall, cantilever to rear of base

Heavy, 16-gauge stainless steel shelves

Bottom shelf adjustable to 19", 21" or 23" in height

Top shelf fixed height of 36" from worktop

16" Deep

Standard with "hat channel" under each shelf for field-added components

Pre-drilled holes for mounting a heat lamp by others

NOTE: Tubular-style overshelves are available as pass-thru shelves only.

Continental
Refrigerator

Toll-Free: 800-523-7138
Phone: 215-244-1400
Fax: 215-244-9579

539 Dunksferry Road
Bensalem, PA 19020
www.continentalrefrigerator.com

Project Name:

Model Specified:

Location:

Item No:

Quantity:

AIA #:

SIS #:

Product Specifications

DIMENSIONAL DATA (ALL MODELS)

Depth (in.)	16 (406 mm)
Height, Bottom Shelf (adjustable) (in.)	19 (483 mm) 21 (533 mm) 23 (584 mm)
Height, Top Shelf (fixed height) (in.)	36 (914 mm)

DOS27

Width (in.)	27 9/16 (700 mm)
Shipping Weight (lbs.)	62 (28 kg)

DOS32

Width (in.)	32 1/16 (814 mm)
Shipping Weight (lbs.)	64 (29 kg)

DOS36

Width (in.)	36 1/16 (916 mm)
Shipping Weight (lbs.)	68 (31 kg)

DOS48

Width (in.)	48 1/16 (1221 mm)
Shipping Weight (lbs.)	72 (33 kg)

DOS60

Width (in.)	60 1/16 (1526 mm)
Shipping Weight (lbs.)	82 (37 kg)

DOS72

Width (in.)	72 1/16 (1830 mm)
Shipping Weight (lbs.)	90 (41 kg)

Figures in parentheses reflect metric equivalents rounded to the nearest whole unit.

APPROVAL:

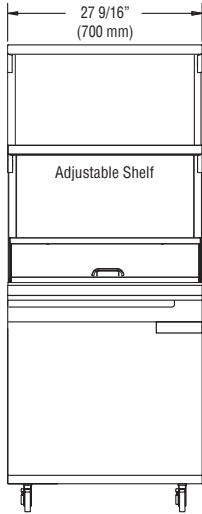

DOS27

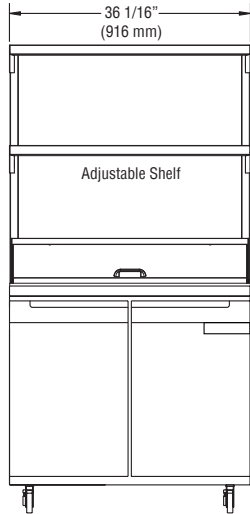

DOS36

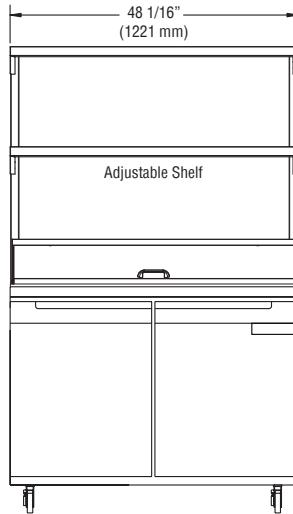

DOS48

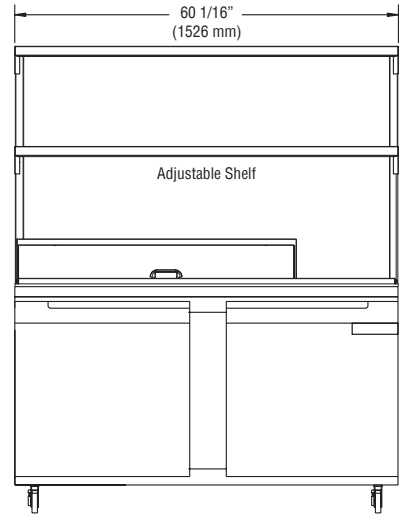

DOS60

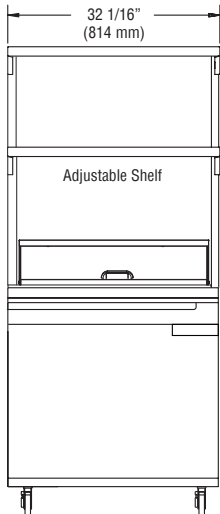

DOS32

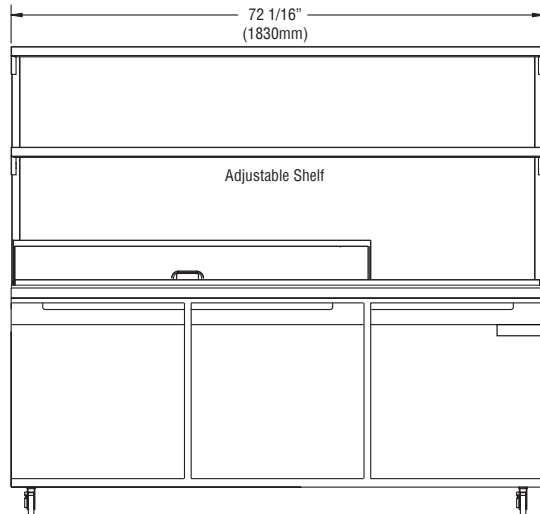

DOS72

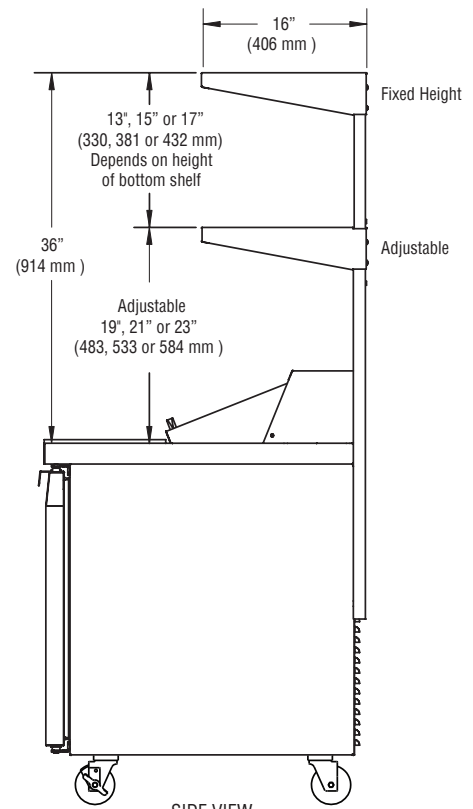

SIDE VIEW

Continental
Refrigerator

Toll-Free: 800-523-7138
Phone: 215-244-1400
Fax: 215-244-9579

539 Dunkserry Road
Bensalem, PA 19020
www.continentalrefrigerator.com

Due to our continued efforts in developing innovative products, specifications subject to change without notice.



MADE IN THE U.S.A.

© Copyright 2015, Continental Refrigerator.
A Division of National Refrigeration & Air Conditioning Products, Inc.