

# Specification Sheet

## FX201G2 Combistar



### Product Description:

- The Angelo Po CombiStar FX is a versatile and advanced cooking system designed to meet the demands of commercial kitchens. With its programmable controls and touch display, this oven allows for precise and efficient cooking.

### Cooking Programs:

- 99 programs with 4 phases.
- Standard 3 re-heating programs, 5 smoking, 4 Low Temperature, and 1 Delta T.
- Pre-Setting for vacuum core probe accessory and smoke accessory.

### Technology and Features:

- Data selection control knob and backlit touch-sensitive keys.
- SC2 washing system with double-action sanitization effect and ECO function.
- RDC (patented) + EVOS steam generator with low management cost and dual-level steam generation system DSG.
- Manual steam injection and automatic cooling and preheating.
- Interface for HACCP data downloading on printer (optional).
- Provision for remote peak power cut and cooking chamber siphon drain to prevent backflow of liquids and smells with T pipe for ventilated downstream installation.
- Armoured direct heat exchanger in incoloy 800 in cooking chamber, cooking fan, and steam generator in AISI 316L stainless steel.
- Ceramic fibre thermal insulation with an anti-radiation barrier.
- Control panel protected by 5 mm of tempered glass, deflector panel between the cooking chamber and exchanger/fan opening on hinges for services and cleaning.
- Door with intermediate stop positions at 90° and 130° and double-tempered glazing with open-cavity and internal low emissive glazing, internal removable glazing, and rock wool.
- Handle with double handgrip and high-strength silicone door seal with two heat barrier lines.
- Condensation collection and drain built-in tray, and all operating elements located near the technical compartment on the left-hand side of the oven.

### Capacity

- 20 x 1/1GN
- Wide range of accessories for various cooking processes such as grilling, braising or baking

### Convection Heat

- 50°F - 572°F (10°C - 300°C)
- 0% - 100% Humidity

### Steam

- 86°F - 257°F (30°C - 125°C)

### Combination

- 6°F - 482°F (30°C - 250°C)
- 0% - 90% Humidity



# Specification Sheet - FX201G2 Combistar









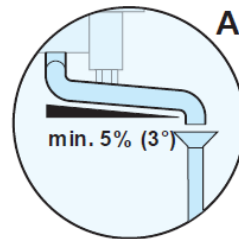
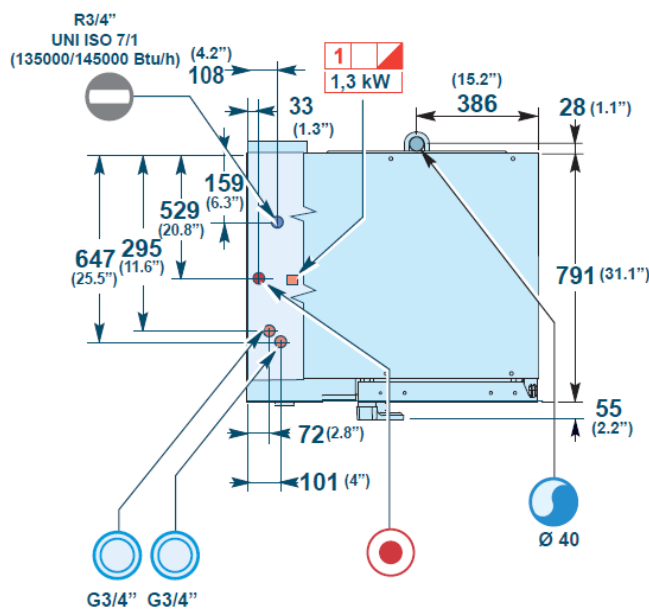
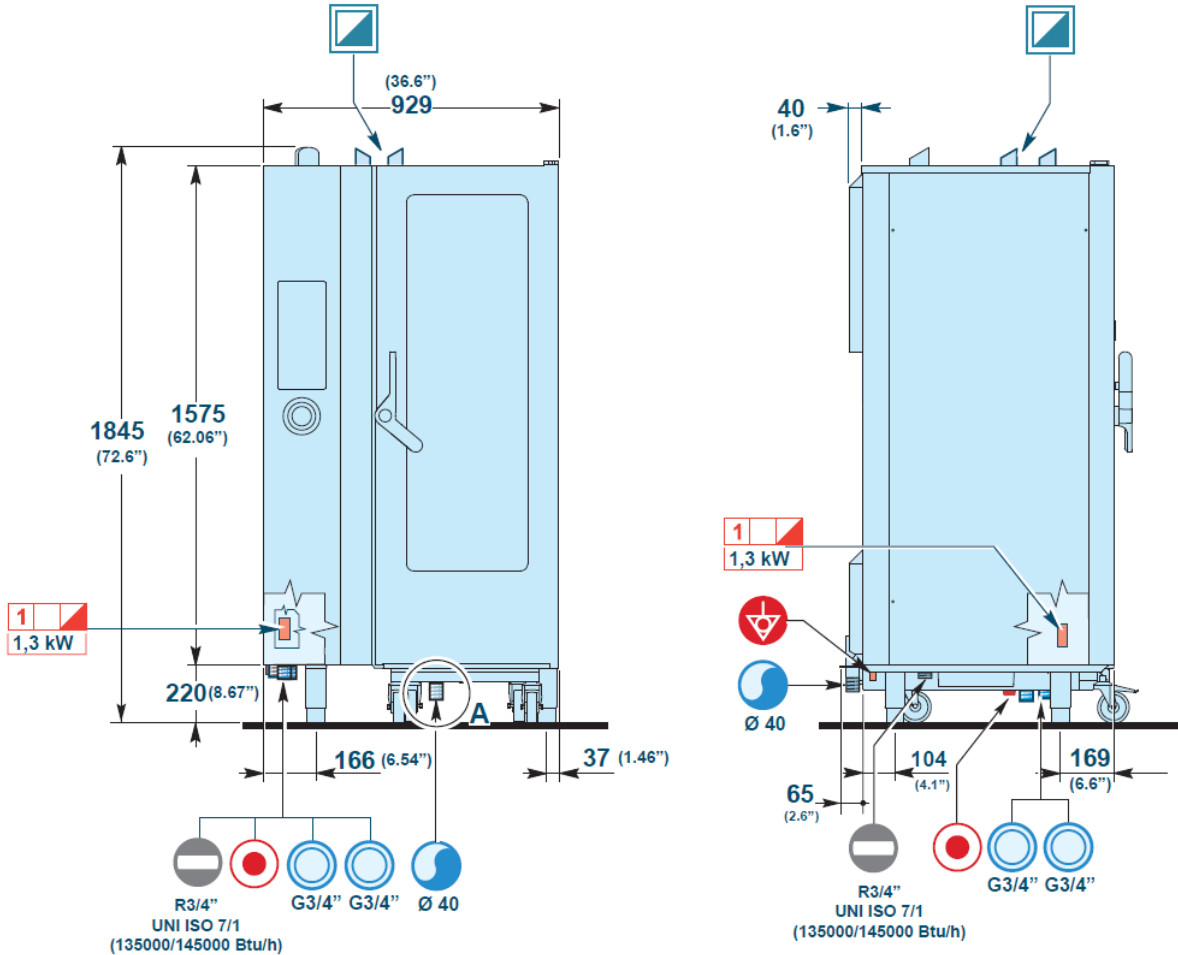

Model	FX201G2 Combistar
Working voltage	230V 1N~ / 50Hz
Net weight	712.09 lbs
Gross weight	789.25 lbs
Packing width	41.26 in
Packing height	85.55 in
Packing depth	40.16 in
Width	37.87 in
Height	73.03 in
Depth	36.81 in
Electric power	1.5 kW
Gas power	40 kW
Electric supply height	9.84 in
Gas diameter	3/4"
Gas supply height	9.84 in
Cold water	15.85 gal/h
Cold water diameter	3/4"
Cold water connection hgt	9.84 in
Water drain diameter	4 in
Water drain height	0.39 in
Dimensions	37.87x36.81x73.03 in
Packing	41.26x40.16x85.55 in
Door opening	from left to right
Capacity in GN containers	20 x 1/1GN
Portions for cooking process	n° 280
Product core probe	Singlepoint, standard
Display	Segment digital
Power supply	Gas
Installation Requirements	Hood Installation is Required for Cooking Smoke; The Oven Must Be Installed Level; Install Water Supply Shut-Off Valve and Back-Flow Preventer
Clearance Requirements	Left side of equipment: 20" from heat source and 19" recommended for service access. Minimum clearance 6-1/2" - When left side clearance is less than 20" from a heat source, please inquire about an Angelo Po heat shield accessory. Right: Min. clearance 3-57/64".

It is highly recommended that the Angelo Po reverse osmosis water treatment systems, as well as Angelo Po brand cleaning chemicals (CL55XL detergent and BR55XL brightener) be used and incorporated into all Angelo Po Combistar combi oven installations. It is the sole responsibility of the owner / operator / purchaser of the Angelo Po equipment, to verify that the incoming water supply is comprehensively tested to meet the Angelo Po water compliance standards, published in this document. Non-compliance with the Angelo Po water standards noted herein could potentially damage the equipment and/or VOID the original manufacturer's standard warranty.

# Specification Sheet

## FX201G2 Combistar



-  Gas input  
Entrée Gas
  -  Cold water input  
Entrée eau froide
  -  Electric connection  
Branchement électrique
  -  Terminal board  
Plaque à bornes  
1~ N  
120 V
  -  Flue gas drain  
Degagement gas brules
  -  Water drain  
Vidage eau
  -  Equipotential terminal  
Borne équipotentiel
- Unit of measurement = mm / in  
 Unité de mesure = mm / in