



DUKERS

Quality Commercial Refrigeration



CHEST FREEZER BD/BG-620



PRODUCT FEATURES

- Equipped with Locking Lids.
- Fan assisted condenser & copper evaporator.
- Temperatures in the cabinet range from -10 to -1 degrees Fahrenheit.
- R290 Natural Refrigerant promotes faster cool down and efficient energy consumption.
- White coated steel exterior & aluminum interior, defrost drain.
- Epoxy coated white baskets.
- 3" casters.
- Solid hinged lid.
- Digital controller and LED temperature display.
- Interior LED light.



TECHNICAL SPECIFICATIONS

Refrigerant	R290
Type of Defrost	Manual
Interior Finish	White
Interior Finish	Embossed aluminum
Temperature Range °F	-10 ~ -1 °F
Compressor Power (HP)	4/9
Nema Config.	NEMA5-20P



HIGH QUALITY STAINLESS STEEL & ROBUST DESIGN



DUKERS

Los Angeles | San Francisco | Dallas
Houston | Florida | Chicago | New Jersey

1-800-931-8628

@ info@dukersusa.com

www.DukersUSA.com

DETAILS & SPECIFICATIONS

CHEST FREEZER BD/BG 620

Front View

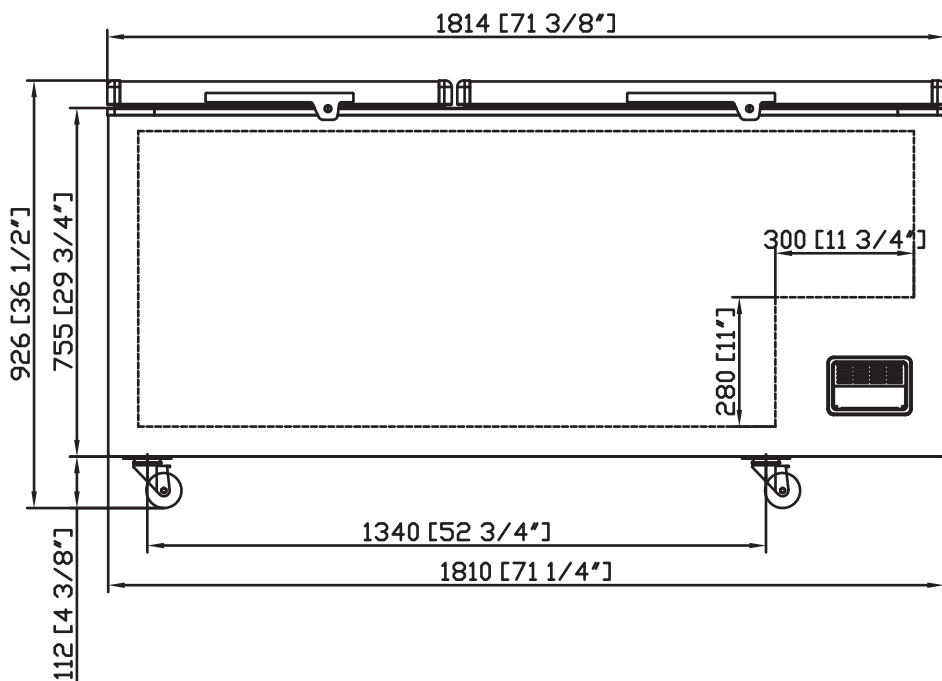

Side View

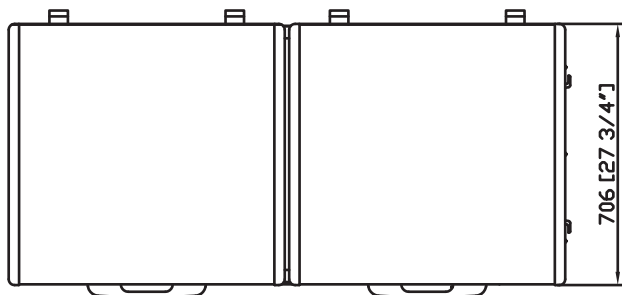
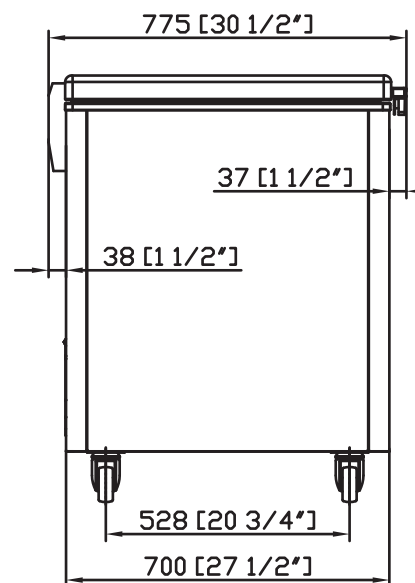

Top View

MODEL BD/BG 620

Number of baskets	2
Compressor Power (HP)	4/9
Refrigerant	R290

MODEL	EXTERNAL DIMENSION WXDXH (INCHES)	PACKAGING DIMENSION WXDXH (INCHES)	PRODUCT NET WEIGHT	# OF BASKETS	40HQ CONTAINER CERT.
BD/BG 620	71 3/8 x 27 3/4 x 36 1/2	76 4/8 x 34 1/8 x 38	176.37 lbs	2	26



Los Angeles | San Francisco | Dallas
Houston | Florida | Chicago | New Jersey

1-800-931-8628

@ info@dukersusa.com

www.DukersUSA.com