



460 Southport Commerce Blvd.
 Spartanburg SC 29306
 Phone: 864-574-6004
 Fax: 864-574-6005
 www.ojedausa.com
 sales@ojedausa.com

Project: _____
 Model #: _____
 Item #: _____ Qty: _____
 Approval: _____

REFRIGERATED DELI CASE

RDCH-6



ELECTRONIC CONTROL

The intelligent temperature control is programmed to ensure the correct operation of the equipment and maintain products at an optimum temperature.

R-290 REFRIGERANT

Equipped with R-290 refrigerant, an eco-friendly alternative that meets the EPA's environmental impact regulations.

LED LIGHTING

LED lighting lasts longer than fluorescent lighting, it reducing energy consumption, which generates minimal heat. All of this makes LED lighting great for the environment.

HOT GAS EVAPORATION

Hot gas heated drain pan for condensate evaporation that eliminates the need of floor drains or electric heaters.

OPERATING TEMPERATURE

32°F-42°F

CUSTOM GRAPHICS

Standard color: black

Dimensions			Crated Dimensions			Shelves	HP	Voltage	NEMA config	Amps	Crated Weight		
	W	D	H		W	D	H	2	1/4	120	5-15P	5	654 lbs
(in)	73.8	35.2	50	(in)	80.8	40	58.3	Net Capacity (cf): 20.5			Energy Consumption: 8.7 kw-hr/day		
(mm)	1874	894	1269	(mm)	2050	1015	1480						

*Inches rounded up one decimal place *Specifics may change without notification



CABINET CONSTRUCTION

- High-density, CFC-Free, polyurethane insulation
- Curved glass
- Exterior: galvanized metal cabinet with powder coated painted surface
- Interior: easy to clean pre-painted steel
- Stainless steel bottom
- Sliding glass doors

SHELVING

- Adjustable shelves
- 67.8" width x 15" depth (1723 mm x 380 mm)
- Weight capacity per shelf 198.4 lbs

OPERATING CONDITIONS

- The unit is best suited for an environment where temperatures remain below 75°F and humidity does not exceed 55%.
- Areas with direct sunlight should also be avoided.

REFRIGERATION

- Maintenance free condenser
- Reverse cycle defrost system
- Hot gas heated pan for condensate evaporation
- R-290 refrigerant

OPTIONS

- Interior mirrored ends
- Cutting board top

WARRANTY

- 3 year parts and labor warranty
- 5 year compressor

LIGHTING

- Horizontal LED lighting
- On/off light switch

4 AMP ACCESSORY RECEPTACLE



LED LIGHTING

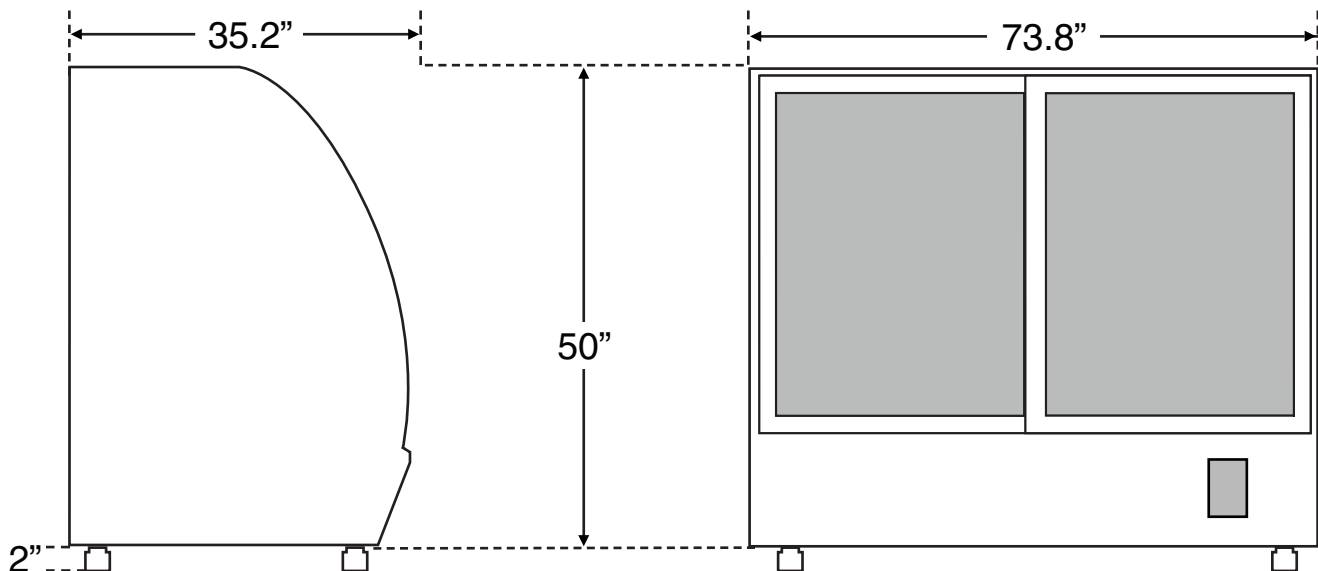

*Specifics may change without notification

