



UNI EN ISO 9001 Cert. n.: 9105.TKWA



PRODUCT – SAFETY – PERFORMANCES – INSTRUCTIONS These are made according to laws, prescriptions, recommendations: CE – EN 60335 – UNI 441 – ISO 9001 – D.L. 115: 17/031995

+39.0331.960474	phone
+39.0331.960166	fax
www.teknaline.com	site
info@teknaline.com	e-mail
Tekna s.r.l. - via Verdi, 35	address
21021 Angera (Va) - Italy	

ATTENTION !!

THIS INSTRUCTION HANDBOOK IS VALID AS WARRANTY AND IT IS FOR A PROPER USE OF THE PRODUCT . IT MUST BA KEPT FOR ALL THE LIFE OF THE PRODUCT

EN

instruction handbook

Chapter 1 – OPENING AND DISPOSING OF THE PACKAGE.

In the position (1) there is the bag with the instructions. Please check that the appliance is not damaged. Damages happened during the transport must be reported to your dealer within 24 hours on receiving.

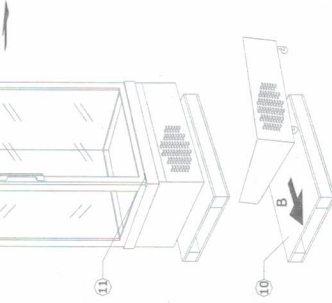
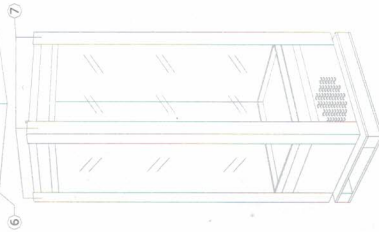
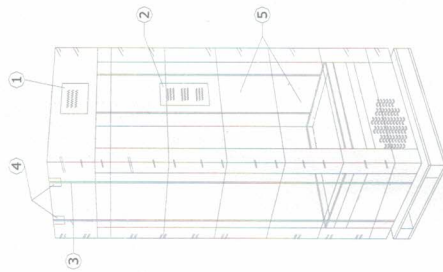

Check that the label with the model (2) corresponds to the invoice. The plastic film permits to check the colour and part of the equipment. If there are no problems you can open the package. With scissors you have to cut the two plastic supports

(3). Recover the four little cardboard angular (4) under the supports. With scissors cut carefully the plastic film (5) from the bottom to the top putting everything in a bag.

Attention: Keep away from children.

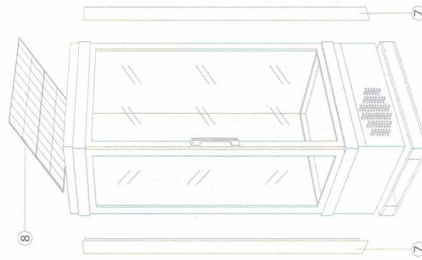

Lift carefully the cardboard cover (6) in order to clear the four long cardboard angular (7) on the four corners of the appliance. Recover with the most frailty and attention the equipment (grid shelves and/or glass shelves) (8) placed on the top of the appliance.

At the same time unthread the pallet.

For this operation is required more than a person. Push carefully the appliance (9), without incline it, towards "A" making run it on the wooden pallet (10) until the first couple of running wheels has gone down. At the same time unthread the pallet (10) toward "B".

Under the door there is a cardboard thickness (11) that must be removed only when the appliance is settled in his final position.

Attention: Do not throw the package components away, take them to an authorised dump and divide them in the following way:

WOOD: Pallet (10)

CARDBOARD: Short angular (4)
Long angular (7)
Covering box (6)
Thickness door (11)

PLASTIC: Plastic film (5)
Support (3)

Attention: If the unit has been transported lied down inform who install the unit.

Attention: All operations ordinary or extraordinary must be carried out by appropriately qualified personnel.

Chapter 2 – INSTALLATION

RECOMMENDATIONS AND CARES

- The regulations of the appliance must be carried out by qualified technician who has read carefully the instructions of this handbook.
- Before starting each type of operation, open the front panel (Fig. 1 - Chapter 3) and control the compound (condenser, solenoid valve, copper tubes...), if not damaged put back the grid gently in its starting position.
- Do not place the appliance next to sources of heat, ex. heaters, kitchen, etc.
- Do not expose the unit to direct sunlight.
- Optimum performance of the unit will occur in an ambience that does not exceed +30°C and 65% relative humidity.
- Leave a space of at least 5 cm on either side of the unit and 20 cm from the ceiling.
- Never block any ventilation holes (base).
- Do not damage the circuit refrigerator.
- Make sure that the appliance has been well levelled.
- Check the rotation of the doors so that they do not interfere with near mobiles or walls.
- Do not place heavy objects on top of the appliance or objects that can vibrate.
- Do not use electrical appliances inside the cell, unless they are of the type recommended by the manufacturer.
- After the installation in the chosen place, let it settle for approximately 1 hour before connecting it to the socket. In the meanwhile, after having cleaned the inside as indicate in the "CLEANING - Recommendations and cares" chapter, settle the equipment.

ELECTRICAL CONNECTION.

Ensure that the unit's plugs is inserted into a 16-Ampere socket.

Before connecting the appliance, make sure that the voltage indicated on the label corresponds to your home voltage. In doubt of the exact voltage, ask your dealer or to the local energy supplier.

This appliance has been built and tested in accordance with international safety rules, therefore it must be fastened to a socket furnished with earth plate.

**EARTH PLATE IS AN OBLIGATORY SAFETY RULE.
THE PRODUCER DECLINES EVERY RESPONSIBILITY OF DAMAGES TO PEOPLE OR
OBJECT IF ELECTRICAL CONNECTION IS MADE DIFFERENTLY FROM WHAT DESCRIBET.**

Insert the plug into the 16 Ampere socket. Do not insert in irregular sockets, reductions or multiple sockets; this may cause the overheating or a false contact that could compromise the operation of the appliance.

Warning: Never manipulate the cable supplied with the unit (for example: change the plug)

Chapter 3 – MAINTENANCE EXTRAORDINARY.

Warning: Extraordinary maintenance on the unit must be carried out by qualified technicians.

Warning: Before starting each type of maintenance unplug the unit from electrical supply!

CLEANING THE CONDENSER.

The appliance has a heat switch inside the cold. It is very important that this part is held in perfect efficiency, because in contrary it could reduce the condenser's power and even BLOCK itself with the risk of **BURNING THE COMPRESSOR**. The condenser must be cleaned on regular period using a dry paintbrush or a vacuum cleaner (Picture 1 – b).

To approach the condenser remove the screw and use a brush as a level in one of the holes of the front grid. Once the fastening has been released the grid will open rotating on pivot pin fastened to the loom (Picture 1 – b).

After the cleaning is done put the back the grid gently in its starting position with your hand, insert the screw.

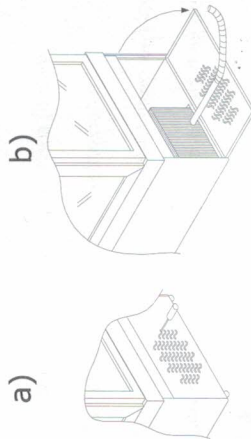

Picture 1

CHANGE THE LAMP.

Warning: Before starting each type of maintenance unplug the unit from electrical supply!

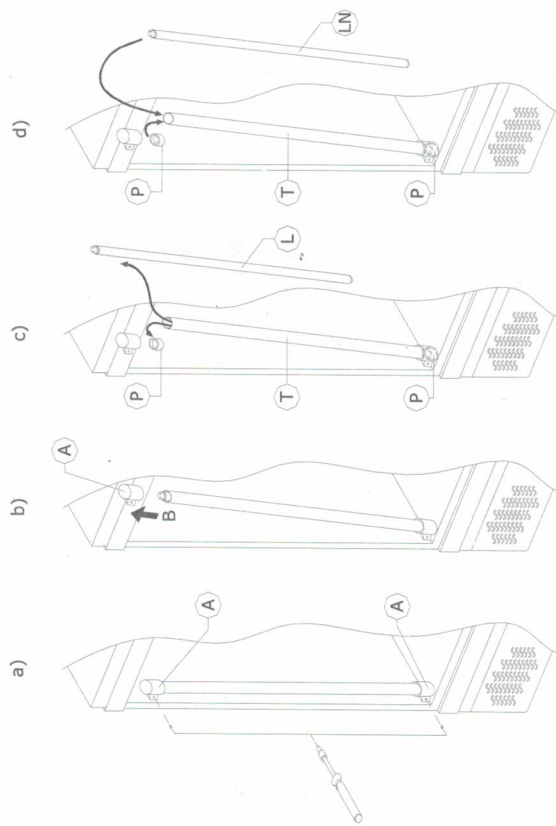

Picture 2

The unit has got tow or more lamps (36 Watt), according to the model, how to replace any lamps:

1. Remove the screws with a head screwdriver the plastic white bracket covers (A) that hold the transparent tube (Picture 2 – a).
2. Delicately remove the white plastic brackets (A) from the top and bottom of the tube, indication arrow "B" (Picture 2 – b).
3. Delicately remove the lamp holder (P), detaching the lamp (L). Remove the lamp from the transparent tube (T) (Picture 2 – c).
4. Replace the lamp (L) with anew lamp of 36 Watt (LN), insert the new lamp into the transparent tube (T), ensure that the lamp holders (P) are fitted on the new lamp, replace the plastic bracket covers (A) (Picture 2 – d), and affix with the screws as per original position (LN)+(P)+(T)+(A).
5. To make sure itself of the correct restoration of the parts.

Chapter 4 - RACCOMANDADION AND NOTE FOR THE USER.

Attenzione: This chapter is dedicate for the user. Read carefully the instructions of this handbook!

- Do not place the appliance next to sources of heat, ex. Heaters, kitchen, etc.
 - Do not expose the unit to direct sunlight.
 - Optimum performance of the unit will occur in an ambience that does not exceed +30°C and 65% relative humidity.
 - Leave a space of at least 5 cm on either side of the unit and 20 cm from the ceiling.
 - Never block any ventilation holes (base).
 - Do not damage the refrigerant circuit.
 - Do not place heavy objects on top of the appliance or objects than can vibrate.
 - Do not use the appliance in order to cool the room (making it works with the door opened)
- TEKVA S.R.L. does not answer for an improper use of the product.
- Ensure that the unit is used only for refrigeration of cold products, do not put anything different or even not correcting (ex. Ice bags, humid towels to cool, etc.).
 - Do not put in the appliance liquids and/or materials with a higher temperature than the exterior room.
 - Do not use electrical appliances inside the cell, unless they are of the type recommended by the manufacturer.
 - Do not fill excessively the shelves. Between the rear side and the shelves must always be some centimetres to permit the air circulation and to uniform the temperature inside.
 - If the unit is not used for a long period of time, turn the unit off and unplug the unit from the electrical supply the plug and after cleaning (Chapter 6) the inside leave the door slightly opened to avoid formation of bad smells.

Warning: Do not leave the appliance with the products inside, unguarded for a long time, because a current lack or a damage may compromise the products conserved. In case you should leave, make sure, of the non-lack of current. Check that the containers of the frozen products do not present compacting between a packet and another due to the liquid exile and than re-frizzed.











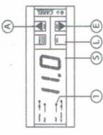

For negative temperature appliances:

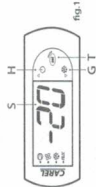
- Do not insert in closed glass containers liquid and/or drinks with a percentage of water superiors than the 50% of the total volume of the contents.
- In case of a blackout check the period of the suspension. If it lasts less than six hours, leave the load in to the appliance and do not open the doors. Consume the de-frozen products within 24 hours.

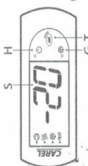
**TEKVA S.R.L. DOES NOT ANSWER FOR AN IMPROPER USE OF THE PRODUCT.
READ CAREFULLY THE CHAPTER "GENERAL CONDITION OF SALE AND WARRANTY".**

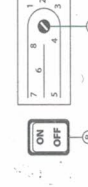
Chapter 5 – FUNCTIONING.

Your appliance has one of the below control zone. According to this zone, read the functioning on the relative page.

<p>VERSION 1</p>	<p>HIGH IN SIGHT</p>  <p>LOW NOT IN SIGHT (Open the front plinth door)</p> 
<p>VERSION 2</p>	<p>HIGH IN SIGHT</p>  
<p>VERSION 3</p>	<p>HIGH IN SIGHT</p>  
<p>VERSION 4</p>	<p>HIGH IN SIGHT</p>  
<p>VERSION 5</p>	<p>HIGH IN SIGHT</p>    <p>LOW NOT IN SIGHT (Open the front plinth door)</p> 

(A) Light switch

(B) General switch

(C) Winding system switch or other

VERSION 1.



Functioning:

This instrument (S) has three relays for the control of the three normal devices of a refrigerated plant: compressor, evaporator fan and defrosting system. The instrument has also an internal sound apparatus as alarm.

1. Press the general switch (B), green pilot lamp or symbol appropriate (Table page. 16). The digital instrument (S) starts; in few seconds appear temperature on the display the cold store. The units now running and will require to pull down to desired temperature continuous operating.
Press the light switch (A) (AUX) for the lighting.
2. The unit has been pre set at the factory of each model.
However if it may be necessary to vary these settings from time to time, operate on the instrument (S) as following:
 - Press the button (L) for about 2 seconds to see the set point value. After few seconds the set point value will begin flashing;
 - Choose the wished value with the button (A) and (E);
 - Press the button again (L) to confirm the new set point value.
3. The appliance has got a "Fan's delay" of about 5 minutes in order to avoid that the hot air circulates into the cell. This happens in each phase of hot starting, included each defrosting cycle of the evaporator.

Defrosting:

The appliance has a special defrosting system *HEAT PUMP*, which is planned to execute the automatic defrosting. The beginning of the defrosting phase is at time. The defrosting function is signalled by the alighting LED (1) (Def.). For a manual defrosting operate pressing the button (E) for about 5 seconds.

Warning: Do not use mechanical devices or other means to accelerate the defrosting process, other than those recommended by the manufacturer.

VERSION 2.

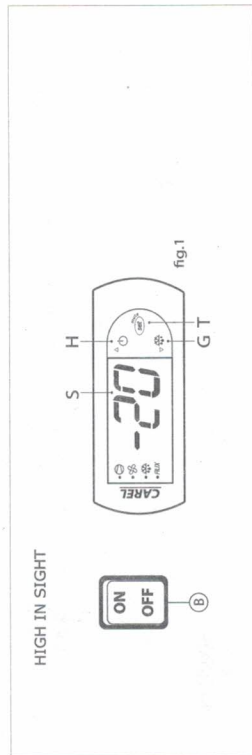

Functioning:

1. Press the general switch (B), green pilot lamp or symbol appropriate (Table page. 16), the digital instrument (S) starts. In few seconds it will appear on the display the temperature of the probe. The appliance is now operating regularly until getting the planned temperature.
2. The unit has been pre set at the factory of each model. However if it may be necessary to vary these settings from time to time, operate on the instrument (S) as following:
 - Press the button (T) for about 2 seconds to see the set point value. After few seconds the set point value will begin flashing;
 - Choose the wished value with the button (H) and (G);
 - Press the button again (T) to confirm the new set point value.

Defrosting:

The appliance has a special defrosting system which is planned to execute automatic defrosting. It is also possible to active a manual defrosting pressing the button (G) for about 5 seconds.

Warning: Do not use mechanical devices or other means to accelerate the defrosting process, or those recommended by the manufacturer.

VERSION 3.

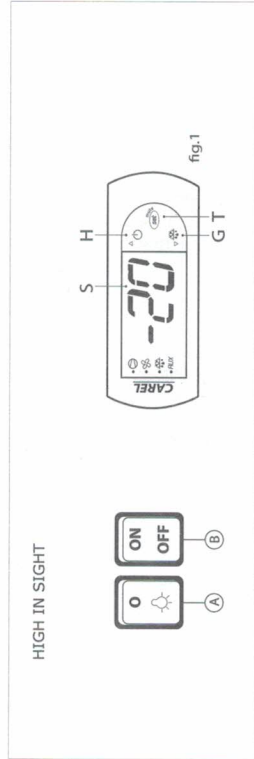

Functioning:

1. Press the general switch (B), green pilot lamp or symbol appropriate (Table page. 16), the digital instrument (S) starts. In few seconds it will appear on the display the temperature of the probe. The appliance is now operating regularly until getting the planned temperature.
2. The unit has been pre set at the factory of each model. However if it may be necessary to vary these settings from time to time, operate on the instrument (S) as following:
 - Press the button (T) for about 2 seconds to see the set point value. After few seconds the set point value will begin flashing;
 - Choose the wished value with the button (H) and (G);
 - Press the button again (T) to confirm the new set point value.
3. Pressing the button (A), yellow pilot lamp or symbol appropriate (Table page. 16), the lights off the cell will go on.

Defrosting:

The appliance has a special defrosting system which is planned to execute automatic defrosting. It is also possible to active a manual defrosting pressing the button (G) for about 5 seconds.

Warning: Do not use mechanical devices or other means to accelerate the defrosting process, or those recommended by the manufacturer.

VERSION 4.

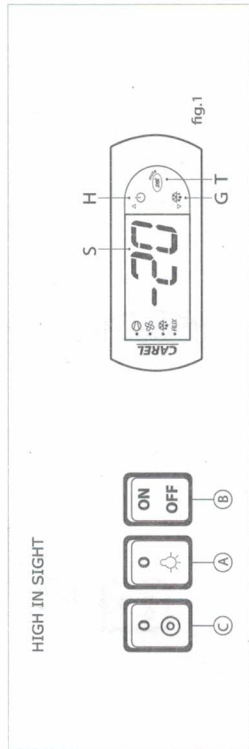

Functioning:

1. Press the general switch (S), green pilot lamp or symbol appropriate (Table page. 16), the digital instrument (S) starts. In few seconds it will appear on the display the temperature of the probe. The appliance is now operating regularly until getting the planned temperature.
2. The unit has been pre set at the factory of each model. However if it may be necessary to vary these settings from time to time, operate on the instrument (S) as following:
 - Press the button (T) for about 2 seconds to see the set point value. After few seconds the set point value will begin flashing;
 - Choose the wished value with the button (H) and (G);
 - Press the button again (T) to confirm the new set point value.

3. Pressing the button (A), yellow pilot lamp or symbol appropriate (Table page. 16), the lights off the cell will go on.
4. Pressing the button (C), yellow pilot lamp or symbol appropriate (Table page. 16), the rotating system will go on (or another electric user of the product).

Defrosting:

The appliance has a special defrosting system which is planned to execute automatic defrosting. It is also possible to active a manual defrosting pressing the button (G) for about 5 seconds.

Warning: Do not use mechanical devices or other means to accelerate the defrosting process, or those recommended by the manufacturer.

VERSION 5.

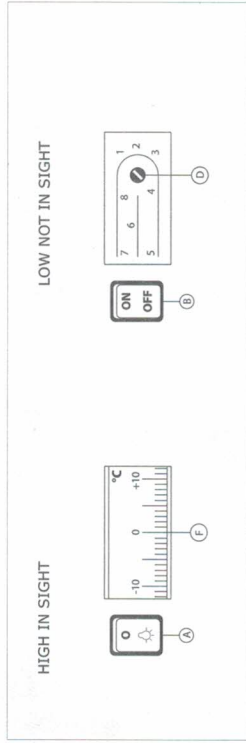

Functioning:

1. Press the general switch (B), green pilot lamp or symbol appropriate (Table page. 16);
2. Get the chosen temperature value in the cold store on the thermometer (F), operate with a coin on the cut part of the knob (D), rotate it clockwise for colder temperatures or counter clockwise for warmer temperatures (regulation possibilities are MIN – MID – MAX from 1 to 8).
3. Pushing the button (A), yellow pilot lamp or symbol appropriate (Table page. 16), the lights off the cell will go on.

Manual defrosting:

1. Switch off the general switch (B).
2. Unplug the unit.
3. Open the front base grid (Picture 1 – a) remove the screw and use a brush as a level in one of the holes of the front grid. Once the fastening has been released the grid will open rotating on pivot pin fastened to the loom.
4. Unlink the rubber drain tube from its support positioned inside the motor space and put it in the container (Picture 2 – b)

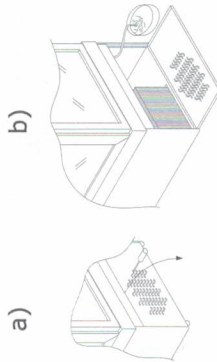

Picture 3

5. Let the refrigerator's door open and wait for all the ice formed on the refrigerated shelves melts. In order to accelerate water evacuation on the bottom of the appliance help water drain towards the entrance or the rubber tube with a sponge.
6. Once evacuation is completed, dry up the inside with a clean cloth, then repeat in reverse order all the initial steps: 4 – 3 – 2 – 1.

Warning: Do not use mechanical devices or other means to accelerate the defrosting process, other than those recommended by the manufacturer.
Do not damage the refrigerant circuit.

Table switch symbol.



Description	Symbol	Function
General switch		Starting
Light switch		The light of the cell goes on.
Rotating system switch or other appliance		Start rotating system

Table 1: Switch symbol.

Operator	Part of appliance	Frequency operation	Type cleaning	Product to use	DO NOT USE
User	Internal surface, shelves, etc...	Every month at least.	Washing	Moistened sponge in warm water and bicarbonate soda.	Detergents abrasives, trieline, alcohol, or analogy products.
			Rinsing	Moistened sponge in clean water.	
			Drying	Soft cloth and/or appropriate paper	
User	External surface, painted parts, Etc...	If dirty, or every month at least.	Washing	Moistened sponge in warm water and bicarbonate soda.	Detergents abrasives, trieline, alcohol, or analogy products.
			Rinsing	Moistened sponge in clean water.	
			Drying	Soft cloth and/or appropriate paper	
Technical personnel qualify	Condenser	Every term at last. (*)	Remove the dry	Dry paintbrush or vacuum cleaner	Screwdriver, knives, etc....

(*) Every month during the pollen period.

Chapter 7 – CEASING OR DEMOLITION.

In case the owner of the appliance would yield it to others both as a payment or free of charge, he is responsible of the products if it is not furnished with this instruction handbook in original, the registration number's label and what other may guarantee the use and the characteristics.
If the owner of the appliance wants to demolish it at the end of the use, he has to follow the below indications.

1. Unplug the unit from the electrical supply;
2. Cut the cable near to the exit, in order to prevent somebody from using it again;
3. In case of demolition of the appliance take it to an authorised dump.

Attention: Do not leave the unit in no-authorised places!

Chapter 8 – GENERAL CONDITION OF SALE AND WARRANTY.

General condition of sale:

- The terms of delivery are not perentory for the firm TEKNA S.R.L. and could be changed for the rising of circumstances beyond one's control or for reason of external or internal order in the firm.
- Any objection must be done at the moment of the collection of the material at TEKNA S.R.L., or at the haulage contractor annotating the defect on the delivery note. Other objection must be done through a registered letter, before and not after eight days after the delivery at the collection of the material.
The possible returned goods, by previous written agreements, does not constitute, in it self, objection of vices to defects, without a specific denunciation before the eight days above mentioned.

General condition of warranty:

- All the products TEKNA sold to the clients have a warranty of a year that the firm TEKNA S.R.L. gives to the final user, through the customer's society, commercial and/or under warranty.
- The non-functioning parts, of which the substitution is required, have to be properly packed and sent, in carriage paid to TEKNA. The substitution from the firm TEKNA will be in carriage forward.
- To have right to the warranty the customer's organisation must transmit to the Commercial and/or Industrial Direction, by filling in and sending the form enclosed, the dates of identification of the products to repair (model and label's number), in addition to the list of the spare parts needed for the reparation.

THE WARRANTY FOR DIRECT OR NOT DIRECT DAMAGES, IT IS LIMITED TO DEFECTS OF CONSTRUCTION DEPENDENT FROM THE FIRM TEKNA S.R.L.

- The technical intervention for reparation, the transport costs of the spare parts from the chief seat are not under warranty (user debit).

Limited warranty:

- Are not under warranty damages and/or anomalous working due to tampering.
- The same warranty, like the "CE" Certification, stops to have effect when pieces or parts (even the gas refrigerated) results disassembled, tampered, substituted, repaired, out of the firm or by someone non authorised from the firm itself.